



Operating Instructions

Adjustment Item Menu Guide: TCRU/ORU

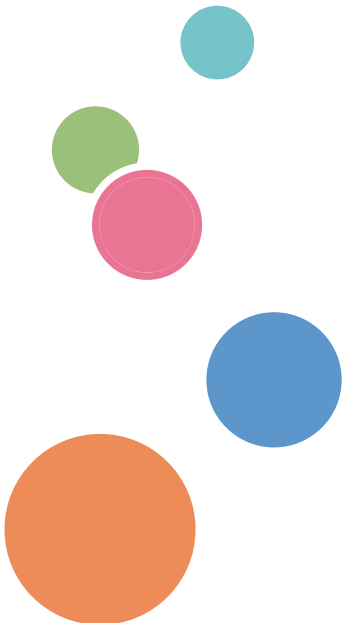

TABLE OF CONTENTS

Introduction.....	7
How to Read This Manual.....	8
Symbols.....	8
Disclaimer.....	8
Notes.....	8
Manuals for This Machine.....	9
Paper Feed Direction of Printed Copies (Side 1/Side 2).....	10
1. Adjustment Settings for Operators	
Accessing Adjustment Settings for Operators.....	13
Layout of Adjustment Settings for Operators.....	14
Features of the Displayed Items and Setting Operations.....	15
Notes on How Adjustment Settings Are Applied to Printed Copies.....	18
2. Details of Menu Items in Adjustment Settings for Operators	
[Machine: Image Position].....	21
0101 [Image Position: Across Feed: Side 1]/0102 [Image Position: Across Feed: Side 2].....	21
0103 [Image Position: With Feed: Side 1]/0104 [Image Position: With Feed: Side 2].....	22
0105 [Perpendicularity Adjustment].....	24
0106 [Switch Paper Edge Detection Sensor].....	24
0107 [Auto Adjust Image Position: No. of Printed Sheets].....	25
[Machine: Image Quality].....	26
0201 [Execute Image Quality Adjustment].....	26
0202 [Maximum Image Density].....	26
0203 [Line Width].....	26
0204 [Density Difference: Across Feed].....	27
[Machine: Paper Feed/ Output].....	28
0301 [3-Tray LCIT: Fan Setting].....	28
0302 [3-Tray LCIT: Fan Volume Setting].....	28
0303 [Pickup Assist Setting].....	28
0304 [Correct Output Paper Curl].....	29
0305 [Detect JAM099].....	30
0306 [Detect JAM080].....	31
0307 [Detect/Control JAM097/098].....	32
0308 [Detect JAM048].....	33

0309 [Registration Gate: Paper Buckle Amount].....	33
0310 [ADF Adjustment].....	34
0311 [Buffer Pass Unit Fan Activation Setting].....	35
0312 [Nip Width of Pressure Position 3 & 4].....	35
[Machine: Productivity].....	37
0401 [No. of Sheets for Auto Color Selection].....	37
0402 [Print Mode When Switching Paper Type].....	37
0403 [Fusing Temperature on Standby].....	37
0404 [Pressure Roller Cooling Fan Level].....	38
[Machine: Maintenance].....	39
0501 [Execute Process Adjustment].....	39
0502 [Screw-on Cap to Replace].....	39
0503 [Execute Charger Unit Cleaning].....	39
0504 [Execute Cleaning Initial Setting for PCU].....	39
0505 [Photoconductor More Lubricant Mode].....	40
0506 [Execute Developer Refreshing].....	40
0507 [Execute ITB Manual Lubrication].....	41
0508 [Manually Smooth Fusing Belt].....	41
0509 [Fusing Belt Manual Smoothing Adjustment].....	41
0510 [Fusing Belt Auto Smoothing Setting].....	42
0511 [Fusing Belt Smoothing Adjustment].....	42
0512 [Fuser Unit Speed Adjustment].....	42
0513 [Wind Fuser Cleaning Unit at Replacement].....	42
0514 [Temperature / Humidity Inside].....	43
0515 [Temperature / Humidity Outside].....	43
0516 [Change Special Toner].....	43
0517 [Switch Print Screen].....	44
0518 [Reset Parts Counter].....	44
0519 [Display Parts Life Counter].....	46
0520 [Special Toner Position].....	48
[Finishing: Finisher].....	50
0601 [Staple Position: Across Feed 1].....	50
0602 [Staple Position: Across Feed 2].....	51

0603 [Staple Position: With Feed].....	51
0604 [Paper Alignment for Stapling: Across Feed].....	52
0605 [Paper Alignment for Stapling: With Feed].....	53
0606 [Number of Sheets Align for Stapling].....	54
0607 [Punch Position: Across Feed].....	55
0608 [Punch Position: With Feed].....	56
0609 [Punch Skew Correction].....	56
0610 [Amount of Punch Skew Correction].....	57
0611 [Paper Alignment in Shift Tray Setting].....	57
0612 [Paper Alignment in Shift Tray: Across Feed].....	58
0613 [Output Tray Descending Position].....	58
0614 [Exit Guide Close Timing].....	59
0615 [Output Trail Edge Press Setting].....	59
0616 [Output Fan Setting].....	59
0617 [Output Fan Level].....	60
0618 [Staple Position for Booklet].....	60
0619 [Folding Position for Booklet].....	61
0620 [Paper Alignment for Booklet: Across Feed].....	62
0621 [Set Number of Folds for Booklet].....	63
0622 [Paper Alignment for Booklet: With Feed].....	64
0623 [Z-fold Skew Correction].....	65
0624 [Amount of Z-fold Skew Correction].....	65
0625 [Amount of Z-fold Skew Correction: Reverse].....	65
0626 [Maximum No. Stacked Sheets in Output Tray].....	66
[Finishing: Fold].....	67
0701 [Z-fold Position 1].....	67
0702 [Z-fold Position 2].....	67
0703 [Half Fold Position: 1 sheet Fold].....	68
0704 [Half Fold Position: Multi-sheet Fold].....	69
0705 [Letter Fold-out Position 1: 1 sheet Fold].....	71
0706 [Letter Fold-out Position 1: Multi-sheet Fold].....	71
0707 [Letter Fold-out Position 2: 1 sheet Fold].....	72
0708 [Letter Fold-out Position 2: Multi-sheet Fold].....	73

0709 [Letter Fold-in Position 1: 1 sheet Fold].....	73
0710 [Letter Fold-in Position 1: Multi-sheet Fold].....	74
0711 [Letter Fold-in Position 2: 1 sheet Fold].....	75
0712 [Letter Fold-in Position 2: Multi-sheet Fold].....	76
0713 [Double Parallel Fold Position 1]/0714 [Double Parallel Fold Position 2].....	77
0715 [Gate Fold Position 1]/0716 [Gate Fold Position 2]/0717 [Gate Fold Position 3].....	78
0718 [Folding Unit Tray Full Detection].....	79
0719 [Number of Sheets Folded after Full Detection].....	79
[Finishing: Perfect Binder].....	81
0801 [Perf Bind Cvr Sht Posit: Across Feed].....	81
0802 [Perf Bind Cvr Sht Posit: With Feed].....	81
0803 [Perfect Binding Finishing Angle].....	81
0804 [Applying Binding Glue].....	82
[Finishing: Stacker].....	83
0901 [Ppr Align in Stack Tray: Acr Feed 1].....	83
0902 [Ppr Align in Stack Tray: Acr Feed 2].....	84
0903 [Paper Alignment in Stacker Tray: With Feed].....	84
0904 [Ppr Align in 2nd Stack Tray: Acr Feed 1].....	85
0905 [Ppr Align in 2nd Stack Tray: Acr Feed 2].....	86
0906 [Ppr Align in 2nd Stack Tray: With Feed].....	87
0907 [Maximum Stack Quantity in Stacker Tray].....	88
[Density Difference Printing: Across Feed].....	90
3. Custom Paper Settings for Administrators	
Accessing Advanced Settings.....	91
Description of Paper Icons.....	92
Deleting Saved Custom Paper Profiles.....	93
Backing up and Restoring Custom Paper Profiles.....	94
Backing up Custom Paper Profiles Registered Under the [CustomPaper Management] Setting.....	94
Backing up and Restoring Custom Paper Profiles Using the External Controller's Control Panel.....	95
Paper Presets in "Advanced Settings".....	96
Displaying the Paper Profile Version.....	96
4. Details of Menu Items in Advanced Settings	
[Machine: Image Position].....	97

1101 [Image Position].....	97
1102 [Auto Adjust Image Position].....	100
1103 [Image Position Feedback Correction].....	101
1104 [Image Position Feedback Correction: Gap].....	101
[Machine: Image Quality].....	103
1201 [Max Image Density].....	103
1212 [Image Transfer Output].....	103
1214 [Paper Transfer Output].....	104
1216 [Paper Transfer Output Correction: Paper Edge].....	105
1218 [Paper Transfer Output: Textured Paper Mode].....	106
1221 [Paper Transfer Separate Voltage].....	107
1222 [Paper Transfer Nip Operation Mode].....	107
1223 [Paper Transfer Nip].....	108
1231 [Print Speed].....	108
1232 [Fusing Temperature].....	110
1233 [Fusing Pressure Temperature].....	113
1234 [Print Mode When Switching Paper Type].....	114
1235 [Fusing Temperature Range].....	114
1236 [Fusing Pressure Roller Cooling].....	116
1237 [Print Speed (Sheet Interval Adj)].....	117
1238 [Fusing Cleaning].....	117
1239 [Erase Margin].....	118
1240 [Fusing Nip Width: Paper Type].....	118
1241 [Fusing Nip Width Adjustment].....	119
1242 [Initial Fusing Temperature for Envelope].....	119
1243 [Fusing Belt Smoothing].....	119
1244 [Fusing Pressure Roller On Before Fusing].....	120
[Machine: Paper Feed/ Output].....	121
1301 [2-Tray LCIT: Paper Feed Mode].....	121
1302 [2-Tray LCIT: Fan/Shutter].....	121
1303 [2-Tray LCIT: Other Settings].....	124
1311 [3-Tray LCIT].....	124
1312 [Main/3-Tray LCIT/Bypass].....	125

1321 [Correct Paper Curl].....	125
1331 [Jam Detection].....	126
1341 [Motor Speed].....	127

Introduction

This manual contains detailed instructions and notes on the operation and use of this machine. For your safety and benefit, read this manual carefully before using the machine. Keep this manual in a handy place for quick reference.

How to Read This Manual

Symbols

This manual uses the following symbols:

Important

Indicates points to pay attention to when using the machine, and explanations of likely causes of paper misfeeds, damage to originals, or loss of data. Be sure to read these explanations.

Note

Indicates supplementary explanations of the machine's functions, and instructions on resolving user errors.

Reference

This symbol is located at the end of sections. It indicates where you can find further relevant information.

[]

Indicates the names of keys on the machine's display or control panels.

Disclaimer

Contents of this manual are subject to change without prior notice.

In no event will the company be liable for direct, indirect, special, incidental, or consequential damages as a result of handling or operating the machine.

Notes

The manufacturer shall not be responsible for any damage or expense that might result from the use of parts other than genuine parts from the manufacturer with your office products.

For good output quality, the manufacturer recommends that you use genuine toner from the manufacturer.

Some illustrations in this manual might be slightly different from the machine.

Certain options might not be available in some countries. For details, please contact your local dealer.

Depending on which country you are in, certain units may be optional. For details, please contact your local dealer.

Manuals for This Machine

The following manuals are for skilled operators only.

Adjustment Item Menu Guide

This manual explains the items in [Adjustment Settings for Operators] and the advanced settings for custom paper adjustment in "Advanced Settings".

Replacement Guide

This manual explains how to replace the machine's components.

Troubleshooting

This manual explains how to troubleshoot problems related to image quality, paper delivery, and other aspects of machine operation.

Paper Feed Direction of Printed Copies (Side 1/Side 2)

Depending on the setting, printed copies are fed as follows:

Side 1 is the surface of the paper printed during one-sided printing, or the surface of the first print during duplex printing.

Side 2 is the surface of the paper printed on the back side of Side 1 during duplex printing.

Single-sided printing: Printed side face down

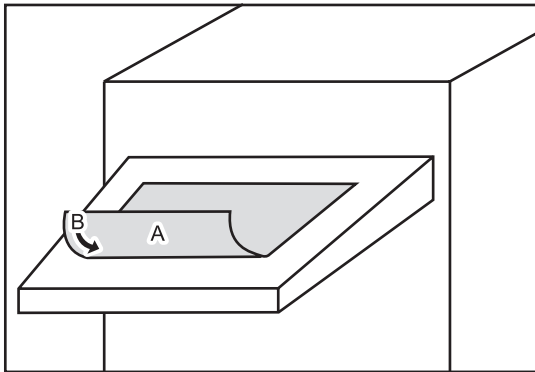

DFP406

A. Side 1

B. Paper feed direction of Side 1

Duplex printing: Printed side face down

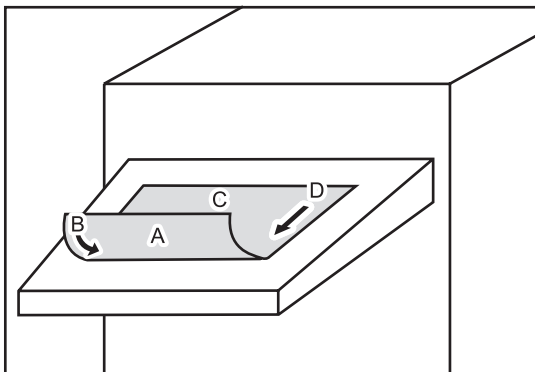

DFP407

A. Side 1

B. Paper feed direction of Side 1

C. Side 2

D. Paper feed direction of Side 2

Single-sided printing: Printed side face up

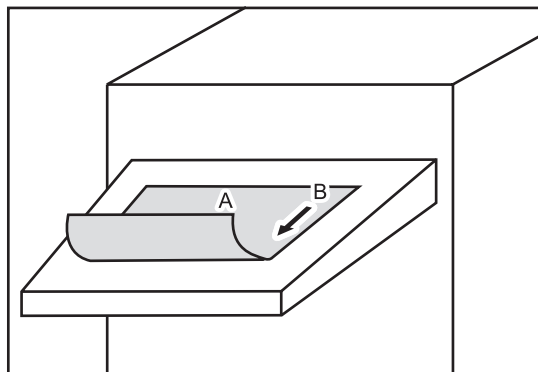

DFP408

A. Side 1

B. Paper feed direction of Side 1

Duplex printing: Printed side face up

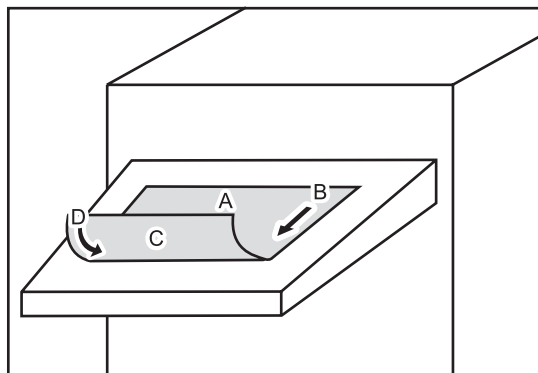

DFP409

A. Side 1

B. Paper feed direction of Side 1

C. Side 2

D. Paper feed direction of Side 2



1. Adjustment Settings for Operators

Accessing Adjustment Settings for Operators

1

1. Press "Login/Logout" () on the top right of the screen.

The name that appears lower the "Login/Logout" icon () depends on the type of administrator logging in.

2. Enter your login user name and password, and then press [Login].

If you are logging on as the administrator for the first time, enter "admin" in User Name.

3. Press [Adjustment Settings for Operators] at the upper left of the screen.

Layout of Adjustment Settings for Operators

This section explains how to use Adjustment Settings for Operators.

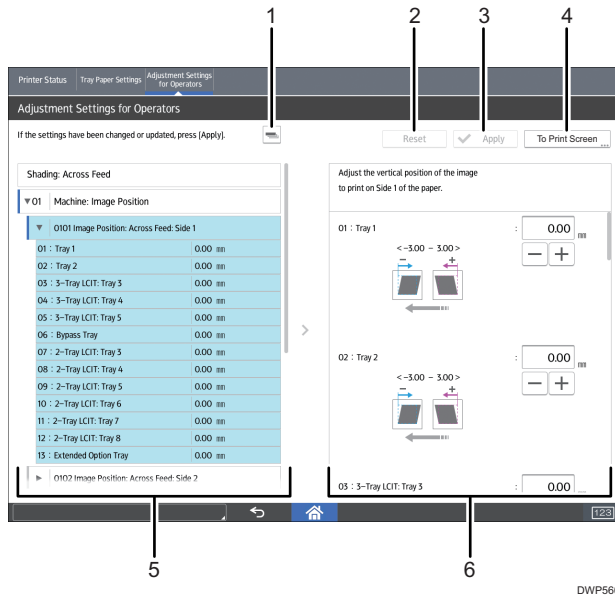

1. 

Press this key to collapse the hierarchical display of the adjustment items and display the group names of those items.

2. **[Reset]**

Press this key to reset the settings/modifications currently configured. You cannot reset the settings/modifications after pressing **[Apply]**.

3. **[Apply]**

Press this key to apply the settings/modifications.

4. **[To Print Screen]**

Press this key to display the print screen. You can use this screen to view the changes you have made.

5. **Adjustment items**

Adjustment items are displayed in this area. When you select an item, its configuration screen will then open.

6. **Configuration screen**

Configure or modify the settings of the adjustment item you select.

DWP560

Features of the Displayed Items and Setting Operations

The following operations are available for each adjustment item:

- Value setting
- Item setting
- Executing
- Display only

Value setting

Press **[+]** or **[-]** to increase or decrease the value respectively, or use the numeric keypad to enter the value.

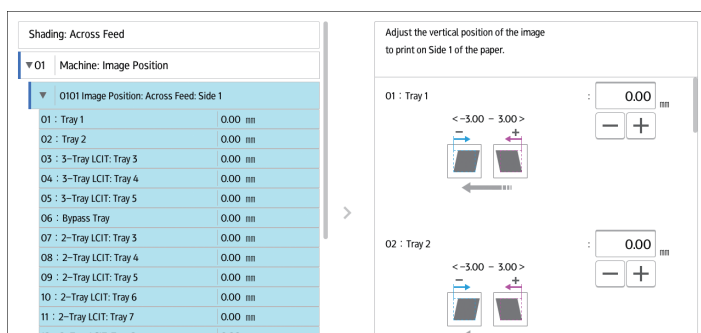

For some settings, move the slider right or left to increase or decrease the setting value.

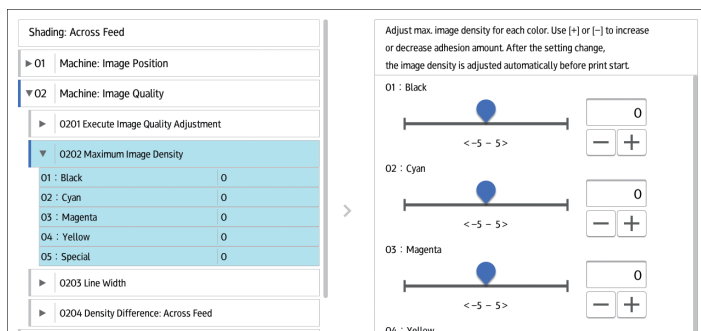

A numeric keypad appears to the left when you press the input box. Use the keypad to enter a value.

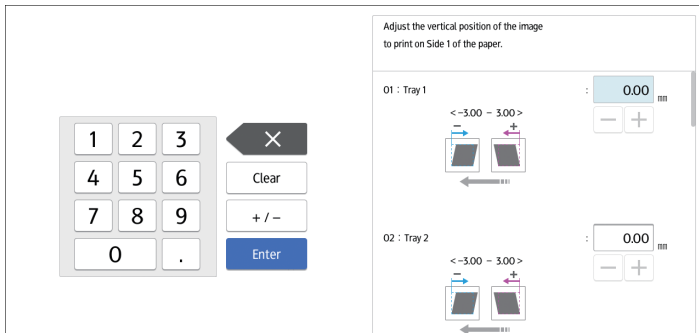

- [X]: Press to delete the entered value character by character.
- [Clear]: Clear the entered value.
- [+/-]: Change the sign of the entered value from + (positive) to - (negative) and vice versa.
- [Enter]: Confirm the entered value.

For some items, you can select a value from the pull-down list that appears when you press the input box. Select a value from the list.

Item setting

Select the item you require.

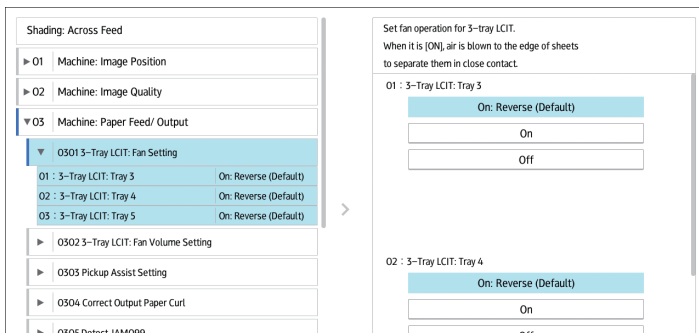

Executing

Press [Execute] to perform a selected function.

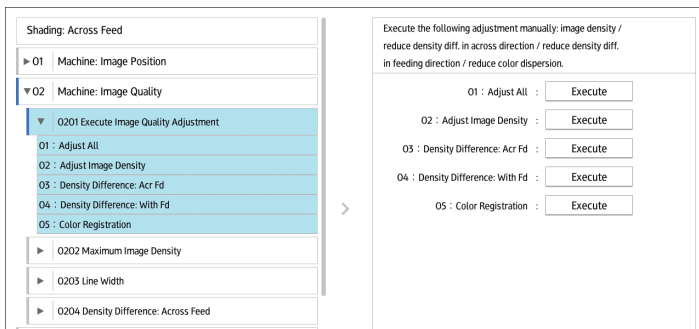

Display only

You can check the setting of the selected item.

▶ 0518 Reset Parts Counter	
▼ 0519 Display Parts Life Counter	
01 : PCU Cleaning Unit (K)	22 %
02 : Charger Unit (K)	22 %
03 : Photoconductor Unit (K)	5 %
04 : PCU Cleaning Unit (C)	19 %
05 : Charger Unit (C)	19 %
06 : Photoconductor Unit (C)	4 %
07 : PCU Cleaning Unit (M)	19 %
08 : Charger Unit (M)	19 %
09 : Photoconductor Unit (M)	4 %
10 : PCU Cleaning Unit (Y)	19 %
11 : Charger Unit (Y)	19 %
12 : Photoconductor Unit (Y)	4 %
13 : PCU Cleaning Unit (S)	7 %

Display the counter value of replacement part.
When it reaches the time to replace,
a message will be shown to recommend the replacement.

Notes on How Adjustment Settings Are Applied to Printed Copies

1

The adjustment settings are applied to printed copies according to the settings specified for each paper tray, paper size, and paper weight.

Depending on the adjustment setting, the same settings specified under different categories may be applied to printed copies concurrently.

- Settings for each paper tray
- Settings for each paper weight
- Settings for each paper size

Settings for each paper tray

These adjustment settings can be specified for each paper tray.

The settings are applied only to printed copies fed from each paper tray.

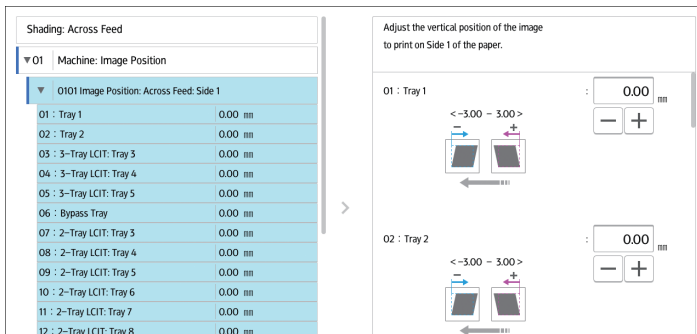

Settings for each paper weight

These adjustment settings can be specified for each paper weight.

The settings are applied only to printed copies of each paper weight ^{*1}.

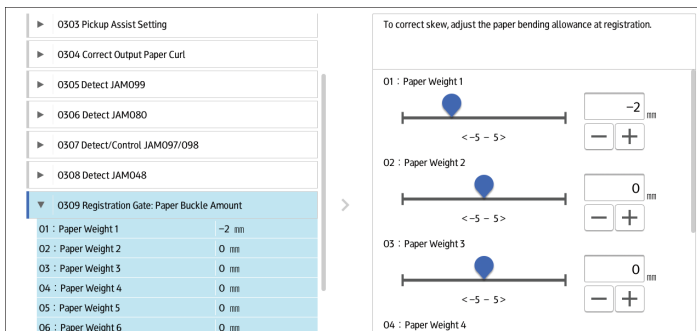

*1 This appears as [Paper Thickness] in "Tray Paper Settings".

Settings for each paper size

These adjustment settings can be specified for each paper size.

The settings are applied only to printed copies of each paper size.

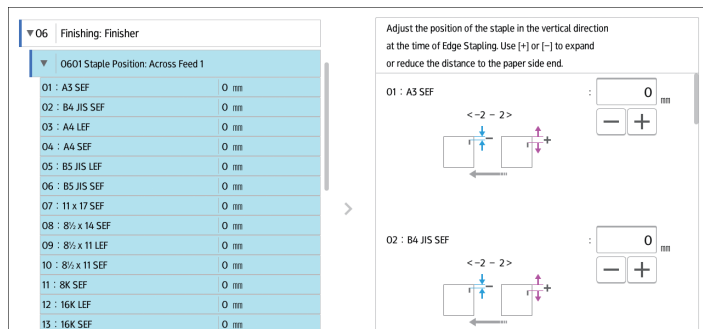

Note

- For information about the paper tray, paper thickness, and tray paper size settings that can be specified for a particular function, see the manual for the relevant function.
- In "Advanced Settings" for custom paper, there are settings identical to those in Adjustment Settings for Operators. When printing is performed from a tray to which the custom paper setting is allocated, the setting in "Advanced Settings" for the custom paper is applied instead of the setting in Adjustment Settings for Operators.

2. Details of Menu Items in Adjustment Settings for Operators

[Machine: Image Position]

0101 [Image Position: Across Feed: Side 1]/0102 [Image Position: Across Feed: Side 2]

Adjust the vertical position of the image to print on Side 1/2 of the paper.

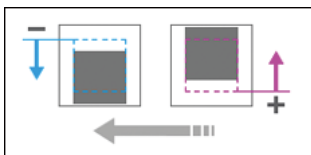

↓ Note

- Depending on the setup, the print side (Side 1/Side 2) with respect to the delivery and paper feed directions may vary. For details, see page 10 "Paper Feed Direction of Printed Copies (Side 1/Side 2)"
- This setting is not effective for paper fed from paper trays with custom paper presets. For such paper, the value specified in [Across Feed] in [Image Position: Side 1]/[Image Position: Side 2] in 1101 [Image Position] in "Advanced Settings" takes precedence.

Setting Items	Default Value	Max. Value	Min. Value	Step	Unit
[Tray 1]	0.0	3.0	-3.0	0.1	mm
[Tray 2]					
[3-Tray LCIT: Tray 3]					
[3-Tray LCIT: Tray 4]					
[3-Tray LCIT: Tray 5]					
[Bypass Tray]					
[2-Tray LCIT: Tray 3]					
[2-Tray LCIT: Tray 4]					
[2-Tray LCIT: Tray 5]					
[2-Tray LCIT: Tray 6]					
[2-Tray LCIT: Tray 7]					
[2-Tray LCIT: Tray 8]					
[Extended Option Tray]					

0103 [Image Position: With Feed: Side 1]/0104 [Image Position: With Feed: Side 2]

Adjust the horizontal position of the image to print on Side 1/2 of the paper.

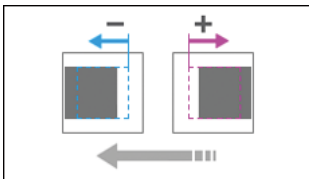

Note

- Depending on the setup, the print side (Side 1/Side 2) with respect to the delivery and paper feed directions may vary. For details, see page 10 "Paper Feed Direction of Printed Copies (Side 1/ Side 2)"
- If the leading-edge margin on Side 1 of the paper is too narrow, paper jams may occur.

- If the trailing-edge margin on Side 1 of the paper is too narrow, paper jams may occur when printing on the back side of paper during duplex printing.

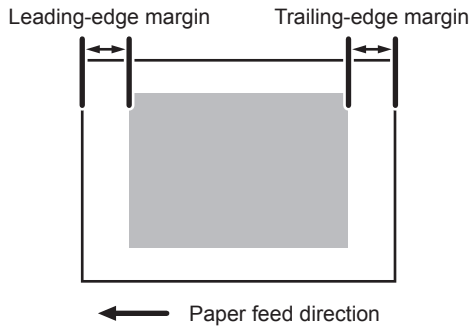

CEZ586

- This setting is not effective for paper fed from paper trays with custom paper presets. For such paper, the value specified in [With Feed] in [Image Position: Side 1]/[Image Position: Side 2] in 1101 [Image Position] in "Advanced Settings" takes precedence.

Setting Items	Default Value	Max. Value	Min. Value	Step	Unit
[Tray 1]	0.0	3.0	-3.0	0.1	mm
[Tray 2]					
[3-Tray LCIT: Tray 3]					
[3-Tray LCIT: Tray 4]					
[3-Tray LCIT: Tray 5]					
[Bypass Tray]					
[2-Tray LCIT: Tray 3]					
[2-Tray LCIT: Tray 4]					
[2-Tray LCIT: Tray 5]					
[2-Tray LCIT: Tray 6]					
[2-Tray LCIT: Tray 7]					
[2-Tray LCIT: Tray 8]					
[Extended Option Tray]					

0105 [Perpendicularity Adjustment]

Correct the perpendicularity of image.

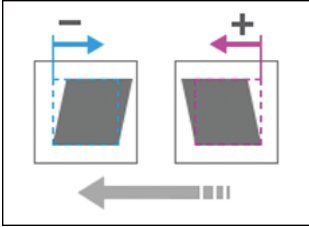

2

Setting Item	Default Value	Max. Value	Min. Value	Step	Unit
[Perpendicularity Adjustment]	0	20	-20	1	None

0106 [Switch Paper Edge Detection Sensor]

Select accuracy of paper edge detection sensor to correct image position in feeding direction. [High Accuracy] makes max. accuracy. Select [Normal] if paper jam occurs due to registration gap.

Setting Items	Values	Default Vaule
[Tray 1]	[Normal]	[Normal]
[Tray 2]	[High Accuracy]	
[3-Tray LCIT: Tray 3]		
[3-Tray LCIT: Tray 4]		
[3-Tray LCIT: Tray 5]		
[Bypass Tray]		
[2-Tray LCIT: Tray 3]		
[2-Tray LCIT: Tray 4]		
[2-Tray LCIT: Tray 5]		
[2-Tray LCIT: Tray 6]		
[2-Tray LCIT: Tray 7]		
[2-Tray LCIT: Tray 8]		
[Extended Option Tray]		

0107 [Auto Adjust Image Position: No. of Printed Sheets]

Set No. of Printed Sheets during Auto Adjust Image Position.

Setting Items	Default Value	Max. Value	Min. Value	Step	Unit
[Side 1: Normal/High Accuracy]	10	100	1	1	None
[Side 2: Normal]					
[Side 2: High Accuracy]	14		5		
[Align Side 1 & 2: Normal/Hi Acc.]	10		1		

[Machine: Image Quality]

0201 [Execute Image Quality Adjustment]

2

Execute the following adjustment manually: image density / reduce density diff. in across direction / reduce density diff. in feeding direction / reduce color dispersion.

Setting Items	Remarks
[Adjust Image Density]	Press [Execute].
[Density Difference: With Fd]	
[Color Registration]	

0202 [Maximum Image Density]

Adjust max. image density for each color. Use [+] or [-] to increase or decrease adhesion amount. After the setting change, the image density is adjusted automatically before print start.

Setting Items	Default Value	Max. Value	Min. Value	Step	Unit
[Black]	0	5	-5	1	None
[Cyan]					
[Magenta]					
[Yellow]					
[Special]* ¹					

*1 This function is available for Pro C7200X, Pro C7210X, Pro C7200SX, and Pro C7210SX.

0203 [Line Width]

Adjust laser beam for image data writing. Halftone dot and fine line becomes thicker when laser beam increases. After setting change, image density is adjusted automatically before print start.

Setting Items	Default Value	Max. Value	Min. Value	Step	Unit
[Black]	0	5	-5	1	None
[Cyan]					
[Magenta]					
[Yellow]					
[Special] ^{*1}					

*1 This function is available for Pro C7200X, Pro C7210X, Pro C7200SX, and Pro C7210SX.

0204 [Density Difference: Across Feed]

Adjust the image density difference in the vertical direction. Use [+] or [-] to increase or decrease the density of lower part of image.

↓ Note

- Depending on the machine's other settings, this setting may have no effect.

Setting Items	Default Value	Max. Value	Min. Value	Step	Unit
[Black]	0	10	-10	1	None
[Cyan]					
[Magenta]					
[Yellow]					
[Special] ^{*1}					

*1 This function is available for Pro C7200X, Pro C7210X, Pro C7200SX, and Pro C7210SX.

[Machine: Paper Feed/ Output]

0301 [3-Tray LCIT: Fan Setting]

Set fan operation for 3-tray LCIT. When it is [ON], air is blown to the edge of sheets to separate them in close contact.

2

Setting Items	Values	Default Value
[3-Tray LCIT: Tray 3]	[Auto Select]	[Auto Select]
[3-Tray LCIT: Tray 4]	[On]	
[3-Tray LCIT: Tray 5]	[Off]	

0302 [3-Tray LCIT: Fan Volume Setting]

Adjust the fan volume for 3-tray LCIT to separate sheets in close contact. Use [+] or [-] to increase or decrease the fan volume.

↓ Note

- This setting is not effective for paper fed from paper trays with custom paper presets. For such paper, the value specified in [Fan Level] in 1311 [3-Tray LCIT] in "Advanced Settings" takes precedence.

Setting Items	Default Value	Max. Value	Min. Value	Step	Unit
[3-Tray LCIT: Tray 3]	50	100	10	10	%
[3-Tray LCIT: Tray 4]					
[3-Tray LCIT: Tray 5]					

0303 [Pickup Assist Setting]

Set the operation of the Paper Feed Roller. By setting it [ON], the contact time of Paper Feed Roller becomes longer and it makes paper feeding easier.

Note

- This setting is not effective for paper fed from paper trays with custom paper presets. For such paper, the value specified in [Pickup Assist] in 1 3 1 2 [Main/3-Tray LCIT/Bypass] in "Advanced Settings" takes precedence.

Setting Items	Values	Default Value
[Tray 1]	[Auto Select]	[Auto Select]
[Tray 2]	[On]	
[3-Tray LCIT: Tray 3]	[Off]	
[3-Tray LCIT: Tray 4]		
[3-Tray LCIT: Tray 5]		
[Bypass Tray]		

0304 [Correct Output Paper Curl]

Select the paper curl correction mode and correction amount.

Setting Items	Values	Default Value
[Tray 1]	[U Curl Correction Level: Off]	[<input type="checkbox"/> Curl Correction Level: Off]
[Tray 2]	[U Curl Correction Level: Small]	
[3-Tray LCIT: Tray 3]	[U Curl Correction Level: Large]	
[3-Tray LCIT: Tray 4]	[<input type="checkbox"/> Curl Correction Level: Off]	
[3-Tray LCIT: Tray 5]	[<input type="checkbox"/> Curl Correction Level: Small]	
[Bypass Tray]	[<input type="checkbox"/> Curl Correction Level: Large]	
[2-Tray LCIT: Tray 3]	[<input type="checkbox"/> Curl Correction Level: Small]	
[2-Tray LCIT: Tray 4]	[<input type="checkbox"/> Curl Correction Level: Large]	
[2-Tray LCIT: Tray 5]		
[2-Tray LCIT: Tray 6]		
[2-Tray LCIT: Tray 7]		
[2-Tray LCIT: Tray 8]		
[Extended Option Tray]		

0305 [Detect JAM099]

Set ON / OFF for JAM099 (detection of multi feed).

Setting Items	Values	Default Value
[Tray 1]	[Off]	[On]
[Tray 2]	[On]	
[3-Tray LCIT: Tray 3]		
[3-Tray LCIT: Tray 4]		
[3-Tray LCIT: Tray 5]		
[Bypass Tray]		
[2-Tray LCIT: Tray 3]		
[2-Tray LCIT: Tray 4]		
[2-Tray LCIT: Tray 5]		
[2-Tray LCIT: Tray 6]		
[2-Tray LCIT: Tray 7]		
[2-Tray LCIT: Tray 8]		
[Extended Option Tray]		

0306 [Detect JAM080]

Set ON/OFF for JAM080 (detect paper jam by deviation in feeding direction).

Setting Items	Values	Default Value
[Tray 1]	[Off]	[On]
[Tray 2]	[On]	
[3-Tray LCIT: Tray 3]		
[3-Tray LCIT: Tray 4]		
[3-Tray LCIT: Tray 5]		
[Bypass Tray]		
[2-Tray LCIT: Tray 3]		
[2-Tray LCIT: Tray 4]		
[2-Tray LCIT: Tray 5]		
[2-Tray LCIT: Tray 6]		
[2-Tray LCIT: Tray 7]		
[2-Tray LCIT: Tray 8]		
[Extended Option Tray]		

0307 [Detect/Control JAM097/098]

Set ON/OFF for J097 (detect deviation in across direction) and J098 (detect paper jam by skew).

Setting Items	Values	Default Value
[Tray 1]	[Off]	[On]
[Tray 2]	[On]	
[3-Tray LCIT: Tray 3]		
[3-Tray LCIT: Tray 4]		
[3-Tray LCIT: Tray 5]		
[Bypass Tray]		
[2-Tray LCIT: Tray 3]		
[2-Tray LCIT: Tray 4]		
[2-Tray LCIT: Tray 5]		
[2-Tray LCIT: Tray 6]		
[2-Tray LCIT: Tray 7]		
[2-Tray LCIT: Tray 8]		
[Extended Option Tray]		

0308 [Detect JAM048]

Set ON/OFF for JAM048 (detect paper jam by detection error of image position correction mark).

Setting Item	Values	Default Value
[Setting]	[Off] [On]	[Off]

0309 [Registration Gate: Paper Buckle Amount]

To correct skew, adjust the paper bending allowance at registration.

Setting Items	Default Value	Max. Value	Min. Value	Step	Unit
[Paper Weight 1]	0	5	-5	1	mm
[Paper Weight 2]					
[Paper Weight 3]					
[Paper Weight 4]					
[Paper Weight 5]					
[Paper Weight 6]					
[Paper Weight 7]	-2				
[Paper Weight 8]					

0310 [ADF Adjustment]

This function is available for Pro C7200S, Pro C7210S, Pro C7200SX, and Pro C7210SX.

Adjust the position and scaling of image when original is scanned by Auto Document Feeder. The deviation, expansion and contraction due to the dispersion of feeding can be corrected.

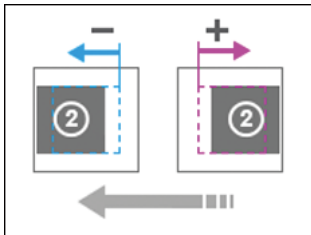
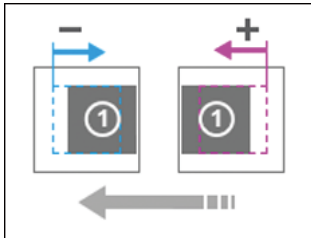

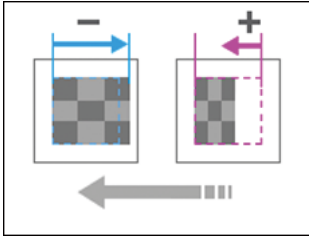

Setting Items	Default Value	Max. Value	Min. Value	Step	Unit
[Img Pos:With Feed:Side1]	0.0	5.0	-5.0	0.1	mm
[Img Pos:With Feed:Side2]					
[Img Magn: With Feed]					%

0311 [Buffer Pass Unit Fan Activation Setting]

Select the fan condition for the Cool Feeding Unit. If the fan is stopped, the mechanical noise would be lower, but there would be a risk of blocking.

Setting Item	Values	Default Value
[Set]	[All Paper Weights] [Weight 3 or Heavier] [Weight 4 or Heavier] [Weight 5 or Heavier] [Weight 6 or Heavier] [Off]	[Weight 3 or Heavier]

0312 [Nip Width of Pressure Position 3 & 4]

Adjust the nip width when the pressure position 3 or 4 is selected for [Fusing Nip Width: Standard] in the Tray Paper Settings.

Setting Items	Default Value	Max. Value	Min. Value	Step	Unit
[Pressure 3]	580	10000	0	5	msec
[Pressure 4]	900				

[Machine: Productivity]

0401 [No. of Sheets for Auto Color Selection]

Set number of sheets to switch color mode. When large number is set, switching frequency will be low and productivity can be kept, but life of units and parts may be shorter.

Setting Items	Default Value	Max. Value	Min. Value	Step	Unit
[FC to BW]	5	10	1	1	sheet(s)
[FCS to FC/BW]					
[FCS to S]	1				
[FCS to S: Swap K & S]	5				

0402 [Print Mode When Switching Paper Type]

Adjust the waiting time by selecting the operation between the consolidated jobs.

Setting Item	Values	Default Value
[Set]	[Fusing Priority Mode] [Normal Mode] [Productivity Mode]	[Normal Mode]

0403 [Fusing Temperature on Standby]

Adjust the fusing conditions in the standby status.

Setting Items	Default Value	Max. Value	Min. Value	Step	Unit
[Heat Rlr: On Standby]	140	200	0	1	deg
[Heat Rlr: On Panel Off]					
[Heat Rlr: Before Process]					
[Press Rlr: On Standby]	70				
[Press Rlr: On Panel Off]					
[Press Rlr: On Low Power]					
[Press Rlr: Before Process]					
[Reload Temp: Press Rlr]					
[Reload Prmt: Press Rlr]					
[Reload: Press Delta: Cool]	20				
[Reload: Press Delta: Warm]					
[Reload: Press Delta: Hot]					

0404 [Pressure Roller Cooling Fan Level]

Adjust the Pressure Roller Cooling Fan level.

Setting Items	Values	Default Value
[Pre-Feed]	[Strong]	[Strong]
[After-Feed]	[Moderate]	[Moderate]
[On Standby]	[Weak] [Stop]	[Weak]

[Machine: Maintenance]

0501 [Execute Process Adjustment]

Execute following multiple adjustments for printing at once: image density /color deviation / charge roller cleaning / charge bias /transfer current correction. It takes 1 to 2 minutes.

Setting Item	Remarks
[Execute]	Press [Execute].

0502 [Screw-on Cap to Replace]

The Toner Bottle Cap closes. The Toner Bottle in use can be pulled out when the Cap is closed. Use it when you want to replace the Toner Bottle.

Setting Items	Remarks
[Black]	Press [Execute].
[Cyan]	
[Magenta]	
[Yellow]	

0503 [Execute Charger Unit Cleaning]

It is used to clean the Charge Roller.

Setting Item	Remarks
[Execute]	Press [Execute].

0504 [Execute Cleaning Initial Setting for PCU]

Execute after replacement of photoconductor cleaning unit and drum. Do not open the left and right front covers during the operation. The control panel shows information during the operation.

Setting Items	Remarks
[KCMY]	Press [Execute].
[CMY]	
[Black]	
[Cyan]	
[Magenta]	
[Yellow]	
[Special]* ¹	

*¹ This function is available for only Pro C7200X, Pro C7210X, Pro C7200SX, and Pro C7210SX.

0505 [Photoconductor More Lubricant Mode]

Increase the amount of lubricant to the drum. If ON is selected, the replacement cycle of the photoconductor cleaning unit may be shortened due to the increase of lubricant amount.

Setting Items	Values	Default Value
[Black]	[Off]	[Off]
[Cyan]	[On]	
[Magenta]		
[Yellow]		
[Special]* ¹		

*¹ This function is available for only Pro C7200X, Pro C7210X, Pro C7200SX, and Pro C7210SX.

0506 [Execute Developer Refreshing]

Replace some part of developer inside the Development Unit.

Setting Items	Remarks
[KCMY]	Press [Execute].
[Black]	
[Special]* ¹	

*¹ This function is available for only Pro C7200X, Pro C7210X, Pro C7200SX, and Pro C7210SX.

0507 [Execute ITB Manual Lubrication]

Apply lubricant to the intermediate transfer belt. This operation takes about 5 minutes

Setting Item	Remarks
[Execute]	Press [Execute].

0508 [Manually Smooth Fusing Belt]

Smooth the Fusing Belt manually.

Setting Items	Remarks
[Belt Scratches]	Press [Execute].
[Uneven Gloss: Short Time]	

0509 [Fusing Belt Manual Smoothing Adjustment]

Set the conditions for manual Fusing Belt smoothing.

Setting Items	Default Value	Max. Value	Min. Value	Step	Unit
[Smoothing Time: Scratch]	120	60000	0	1	None
[Smooth.Time: Uneven Gloss]	10				

0510 [Fusing Belt Auto Smoothing Setting]

Set the conditions for automatic Fusing Belt smoothing.

Setting Items	Values	Default Value
[Auto Exe: Belt Scratches]	[Normal] [Frequently (With Density Adj)] [More Frequently] [Most Frequently]	[Normal]
[Auto Exe: Uneven Gloss]	[Off] [On]	[On]

0511 [Fusing Belt Smoothing Adjustment]

Set the conditions for Fusing Belt smoothing.

Setting Items	Default Value	Max. Value	Min. Value	Step	Unit
[RollerSpeed: Scratch: Short]	100	100	50	1	None
[RollerSpeed: Scratch: Long]					
[Roller Speed: Uneven Gloss]					

0512 [Fuser Unit Speed Adjustment]

Adjust the rotation speed of the Fusing Unit

Setting Item	Remarks
[Execute]	Press [Execute].

0513 [Wind Fuser Cleaning Unit at Replacement]

Wind Fusing Cleaning Web

Setting Item	Remarks
[Execute]	Press [Execute].

0514 [Temperature / Humidity Inside]

Display temperature and humidity inside the machine.

Setting Items	Remarks
[PCU Temperature]	Value display only.
[PCU Humidity]	
[Machine Temperature]	

0515 [Temperature / Humidity Outside]

Display temperature and humidity around the machine.

Setting Items	Remarks
[Temperature]	Value display only.
[Humidity]	

0516 [Change Special Toner]

This function is available for Pro C7200X, Pro C7210X, Pro C7200SX, and Pro C7210SX.

1) Replace special toner cartridge with replacement kit. 2) Press [Set]. 3) Close the dialog box after adjustment completes. 4) Replace the kit with other cartridge. 5) Refer to manual.

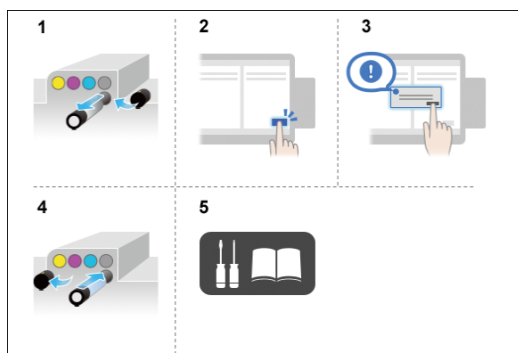

Setting Item	Remarks
[Execute]	Press [Execute].

0517 [Switch Print Screen]

2

This function is available for Pro C7200S, Pro C7210S, Pro C7200SX, and Pro C7210SX.

Set the function displayed when pressing [To Print Screen].

Setting Item	Values	Default Value
[Setting]	[Copier] [Printer]	[Copier]

0518 [Reset Parts Counter]

Reset the counter value of replacement part after the replacement. Refer to "Replacement Manual" for the procedure of part replacement.

Setting Items	Remarks
[PCU Cleaning Unit (K)]	Press [Execute].
[Charger Unit (K)]	
[Photoconductor Unit (K)]	
[PCU Cleaning Unit (C)]	
[Charger Unit (C)]	
[Photoconductor Unit (C)]	
[PCU Cleaning Unit (M)]	
[Charger Unit (M)]	
[Photoconductor Unit (M)]	
[PCU Cleaning Unit (Y)]	
[Charger Unit (Y)]	
[Photoconductor Unit (Y)]	
[PCU Cleaning Unit (S)]* ¹	
[Charger Unit (S)]* ¹	
[Photoconductor Unit (S)]* ¹	
[ITB Cleaning Unit]	
[Paper Transfer Unit]	
[Fuser Unit]	
[Fusing Belt Smoothing Rlr]	

Setting Items	Remarks
[Fuser Cleaning Unit]	Press [Execute].
[Ozone Filter (Main)]	
[Dust Filter (Main)]	
[Tray 1]	
[Tray 2]	
[3-Tray LCIT: Tray 3]	
[3-Tray LCIT: Tray 4]	
[3-Tray LCIT: Tray 5]	
[Bypass Tray]	
[Interposer Upper Tray]	
[Interposer Lower Tray]	
[ADF]*2	
[2-Tray LCIT:Tray3:Fd Blt]	
[2-Tray LCIT:Tray4:Fd Blt]	
[2-Tray LCIT:Tray5:Fd Blt]	
[2-Tray LCIT:Tray6:Fd Blt]	
[2-Tray LCIT:Tray7:Fd Blt]	
[2-Tray LCIT:Tray8:Fd Blt]	

*1 This function is available for Pro C7200X, Pro C7210X, Pro C7200SX, and Pro C7210SX.

*2 This function is available for Pro C7200S, Pro C7210S, Pro C7200SX, and Pro C7210SX.

0519 [Display Parts Life Counter]

Display the counter value of replacement part. When it reaches the time to replace, a message will be shown to recommend the replacement.

Setting Items	Remarks
[PCU Cleaning Unit (K)]	Value display only.
[Charger Unit (K)]	
[Photoconductor Unit (K)]	
[PCU Cleaning Unit (C)]	
[Charger Unit (C)]	
[Photoconductor Unit (C)]	
[PCU Cleaning Unit (M)]	
[Charger Unit (M)]	
[Photoconductor Unit (M)]	
[PCU Cleaning Unit (Y)]	
[Charger Unit (Y)]	
[Photoconductor Unit (Y)]	
[PCU Cleaning Unit (S)]* ¹	
[Charger Unit (S)]* ¹	
[Photoconductor Unit (S)]* ¹	
[ITB Cleaning Unit]	
[Paper Transfer Unit]	
[Fuser Unit]	
[Fusing Belt Smoothing Rlr]	

Setting Items	Remarks
[Fuser Cleaning Unit]	Value display only.
[Ozone Filter (Main)]	
[Dust Filter (Main)]	
[Tray 1]	
[Tray 2]	
[3-Tray LCIT: Tray 3]	
[3-Tray LCIT: Tray 4]	
[3-Tray LCIT: Tray 5]	
[Bypass Tray]	
[Intpsr. Upper]	
[Intpsr. Lower]	
[ADF]*2	
[2-Tray LCIT:Tray3:Fd Blt]	
[2-Tray LCIT:Tray4:Fd Blt]	
[2-Tray LCIT:Tray5:Fd Blt]	
[2-Tray LCIT:Tray6:Fd Blt]	
[2-Tray LCIT:Tray7:Fd Blt]	
[2-Tray LCIT:Tray8:Fd Blt]	

*1 This function is available for Pro C7200X, Pro C7210X, Pro C7200SX, and Pro C7210SX.

*2 This function is available for Pro C7200S, Pro C7210S, Pro C7200SX, and Pro C7210SX.

0520 [Special Toner Position]

This function is available for Pro C7200X, Pro C7210X, Pro C7200SX, and Pro C7210SX.

1)Select whether to print special toner first or last. 2)Press [Set]. 3)Close dialog box after adjustment completes. 4)Turn the power off. 5)Refer to manual and swap sub hoppers/development units.

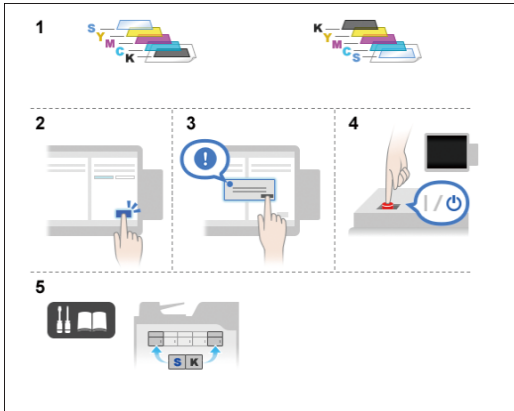

Setting Item	Values	Default Value
[Sub Hopper/Dev. Unit Position]	[Print Special Toner Last] [Print Special Toner First]	[Print Special Toner Last]

[Finishing: Finisher]

0601 [Staple Position: Across Feed 1]

2

Adjust the position of the staple in the vertical direction at the time of Edge Stapling. Use [+] or [-] to expand or reduce the distance to the paper side end.

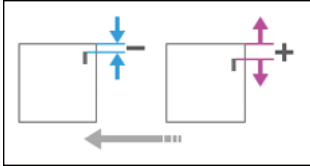

Setting Items	Default Value	Max. Value	Min. Value	Step	Unit
[A3 SEF]	0	2	-2	1	mm
[B4 JIS SEF]					
[A4 LEF]					
[A4 SEF]					
[B5 JIS LEF]					
[B5 JIS SEF]					
[11 × 17 SEF]					
[8 ¹ / ₂ × 14 SEF]					
[8 ¹ / ₂ × 11 LEF]					
[8 ¹ / ₂ × 11 SEF]					
[8K SEF]					
[16K LEF]					
[16K SEF]					
[Other Paper Sizes]					

0602 [Staple Position: Across Feed 2]

Adjust the space of the two staples in the vertical direction. Use [+] or [-] to expand or shrink the space.

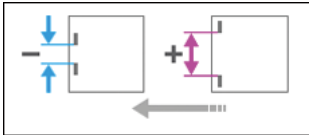

2

Setting Items	Default Value	Max. Value	Min. Value	Step	Unit
[A3 SEF]	0	115	-16	1	mm
[B4 JIS SEF]		75			
[A4 LEF]		115			
[A4 SEF]		28			
[B5 JIS LEF]		75			
[B5 JIS SEF]		0			
[11 × 17 SEF]		98			
[8 ¹ / ₂ × 14 SEF]		34			
[8 ¹ / ₂ × 11 LEF]		98			
[8 ¹ / ₂ × 11 SEF]		34			
[8K SEF]		85			
[16K LEF]		85			
[16K SEF]		12			
[Other Paper Sizes]		115			

0603 [Staple Position: With Feed]

Adjust the position of the staple in the horizontal direction. Use [+] or [-] to expand or reduce the distance to the back end of paper.

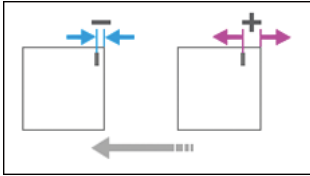

2

Setting Items	Default Value	Max. Value	Min. Value	Step	Unit
[A3 SEF]	0.0	1.5	-1.5	0.1	mm
[B4 JIS SEF]					
[A4 LEF]					
[A4 SEF]					
[B5 JIS LEF]					
[B5 JIS SEF]					
[11 × 17 SEF]					
[8 ¹ / ₂ × 14 SEF]					
[8 ¹ / ₂ × 11 LEF]					
[8 ¹ / ₂ × 11 SEF]					
[8K SEF]					
[16K LEF]					
[16K SEF]					
[Other Paper Sizes]					

0604 [Paper Alignment for Stapling: Across Feed]

Adjust the width of the Staple Jogger to reduce the dispersion of paper orientation in right angle due to paper size, thickness, curl and so on. Use [+] or [-] to expand or reduce the width.

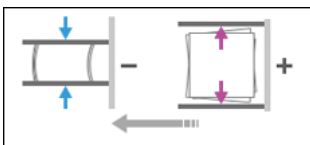

Setting Items	Default Value	Max. Value	Min. Value	Step	Unit
[A3 SEF]	0.0	1.0	-1.0	0.1	mm
[B4 JIS SEF]					
[A4 LEF]					
[A4 SEF]					
[B5 JIS LEF]					
[B5 JIS SEF]					
[11 × 17 SEF]					
[8 ¹ / ₂ × 14 SEF]					
[8 ¹ / ₂ × 11 LEF]					
[8 ¹ / ₂ × 11 SEF]					
[8K SEF]					
[16K LEF]					
[16K SEF]					
[Other Paper Sizes]					

0605 [Paper Alignment for Stapling: With Feed]

Adjust Tip Stopper movement when using Edge Stapling. It reduces diversion of paper alignment in horizontal direction due to paper size, thickness, curl, etc. Use [+] or [-] to increase or decrease movement.

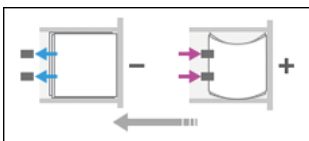

Setting Items	Default Value	Max. Value	Min. Value	Step	Unit
[A3 SEF]	0.0	2.5	-2.5	0.1	mm
[B4 JIS SEF]					
[A4 LEF]					
[A4 SEF]					
[B5 JIS LEF]					
[B5 JIS SEF]					
[11 × 17 SEF]					
[8 ¹ / ₂ × 14 SEF]					
[8 ¹ / ₂ × 11 LEF]					
[8 ¹ / ₂ × 11 SEF]					
[8K SEF]					
[16K LEF]					
[16K SEF]					
[Other Paper Sizes]					

0606 [Number of Sheets Align for Stapling]

Set no. of sheets to align for Stapling at one time. Adjust it when sheets are not aligned due to type, condition or no. of sheets. When no. is less, it takes more time and productivity is low.

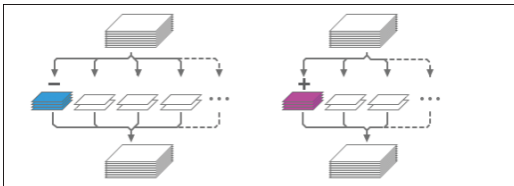

Setting Items	Default Value	Max. Value	Min. Value	Step	Unit
[A3 SEF]	4	4	0	1	sheet(s)
[B4 JIS SEF]					
[A4 LEF]	6	6			
[A4 SEF]	4	4			
[B5 JIS LEF]	6	6			
[B5 JIS SEF]	4	4			
[11 × 17 SEF]					
[8 ¹ / ₂ × 14 SEF]					
[8 ¹ / ₂ × 11 LEF]	6	6			
[8 ¹ / ₂ × 11 SEF]	4	4			
[8K SEF]					
[16K LEF]	6	6			
[16K SEF]	4	4			
[Other Paper Sizes]	0	9			

0607 [Punch Position: Across Feed]

Adjust the position (top and bottom) of punch holes in the across direction. Use [+] or [-] to move punch hole up (far side) or down (front side).

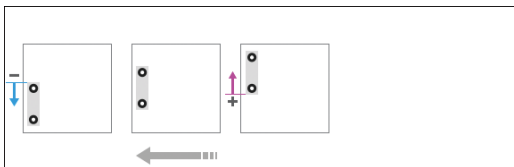

Setting Items	Default Value	Max. Value	Min. Value	Step	Unit
[2 Holes JP/ EU]	0.0	2.0	-2.0	0.5	mm
[3 Holes US]					
[4 Holes EU]					
[4 Holes NE]					
[2 Holes US]					

0608 [Punch Position: With Feed]

Adjust the position (left and right) of the punch holes in the feeding direction. Use [+] to move away from the back end, and [-] to move toward the back end.

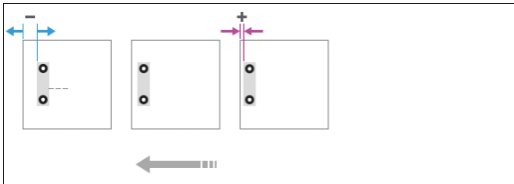

Setting Items	Default Value	Max. Value	Min. Value	Step	Unit
[2 Holes JP/ EU]	0.0	4.0	-4.0	0.5	mm
[3 Holes US]					
[4 Holes EU]					
[4 Holes NE]					
[2 Holes US]					

0609 [Punch Skew Correction]

Set whether or not to correct the punch skew. If jam or ear-fold occurs at the punch section especially when thin paper is used, set it to [Off].

Setting Item	Values	Default Value
[Setting]	[On (Default)] [Off]	[On (Default)]

0610 [Amount of Punch Skew Correction]

2

Adjust the punch skew level. It reduces the punch skew due to paper size, thickness and curl. Set [+] to increase the correction amount.

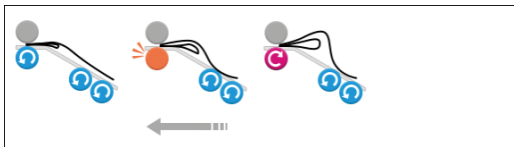

Setting Items	Default Value	Max. Value	Min. Value	Step	Unit
[A4 LEF]	0.0	1.0	-1.0	0.5	mm
[B5 JIS LEF]					
[A5 LEF]					
[A5 SEF]					
[8 ¹ / ₂ × 11 LEF]					
[5 ¹ / ₂ × 8 ¹ / ₂ LEF]					
[5 ¹ / ₂ × 8 ¹ / ₂ SEF]					
[Other Paper Sizes]					

0611 [Paper Alignment in Shift Tray Setting]

Set the alignment precision of output sheets during Shift Sorting. If the top sheet skews, select [Accuracy Priority] to reduce the skew.

Setting Item	Values	Default Value
[Setting]	[Speed Priority] [Accuracy Priority]	[Speed Priority]

0612 [Paper Alignment in Shift Tray: Across Feed]

Adjust the width of Paper Alignment Jogger on Shift Tray. It reduces diversion of paper in vertical direction due to paper size, thickness and curl. Use [+] or [-] to expand or reduce the width.

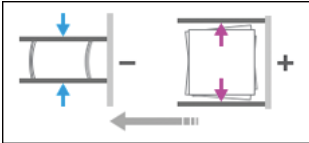

2

Setting Items	Default Value	Max. Value	Min. Value	Step	Unit
[A3 SEF]	0.0	1.0	-1.0	0.1	mm
[B4 JIS SEF]					
[A4 LEF]					
[A4 SEF]					
[B5 JIS LEF]					
[B5 JIS SEF]					
[A5 LEF]					
[A5 SEF]					
[11 × 17 SEF]					
[8 ¹ / ₂ × 14 SEF]					
[8 ¹ / ₂ × 11 LEF]					
[8 ¹ / ₂ × 11 SEF]					
[5 ¹ / ₂ × 8 ¹ / ₂ LEF]					
[5 ¹ / ₂ × 8 ¹ / ₂ SEF]					
[Other Paper Sizes]					

0613 [Output Tray Descending Position]

Set the tray descent range proper to paper weight. Setting proper descent range makes right output and prevents diversion of sheets on the tray.

Setting Item	Selection	Default Value
[Setting]	[Paper Weight 1] [Paper Weight 2] [Paper Weight 3-8]	[Paper Weight 1]

0614 [Exit Guide Close Timing]

Set the timing to close the Paper Exit Guide. The proper timing for the paper in use prevents the deflection of the staple bundle at the time of ejection.

Setting Item	Selection	Default Value
[Setting]	[Default] [Thin Paper]	[Default]

0615 [Output Trail Edge Press Setting]

Set whether or not to hold the trailing edge of sheets when ejected on the Shift Tray. Setting it [ON] reduces the diversion of sheets due to the paper type and paper condition.

Setting Item	Selection	Default Value
[Setting]	[Auto] [On] [Off]	[Auto]

0616 [Output Fan Setting]

Set the fan operation to the sheets on the shift tray. Air blowing peels off the sheets in close contact.

Setting Item	Selection	Default Value
[Setting]	[Auto] [On] [Off]	[Auto]

0617 [Output Fan Level]

Adjust the fan volume to the sheets on the shift tray. Increase the air level if the sheets are in close contact.

Setting Item	Selection	Default Value
[Setting]	[Auto] [Increase Air Volume]	[Auto]

0618 [Staple Position for Booklet]

Adjust the position of the Saddle Stitch Staple. In left and right spread status, move to right with [+] and to left with [-].

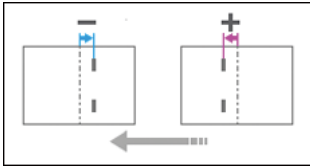

Setting Items	Default Value	Max. Value	Min. Value	Step	Unit
[A3 SEF]	0.0	1.0	-1.0	0.2	mm
[B4 JIS SEF]					
[A4 SEF]					
[B5 JIS SEF]					
[SRA3 SEF]					
[SRA4 SEF]					
[13 × 19 ¹ / ₅ SEF]					
[13 × 19 SEF]					
[13 × 18 SEF]					
[12 ³ / ₅ × 19 ¹ / ₅ SEF]					
[12 ³ / ₅ × 18 ¹ / ₂ SEF]					
[12 × 18 SEF]					
[11 × 17 SEF]					
[8 ¹ / ₂ × 14 SEF]					
[8 ¹ / ₂ × 11 SEF]					
[Other Paper Sizes]					

0619 [Folding Position for Booklet]

Adjust the folding position. In left and right spread state, move to right with [+] and left with [-].

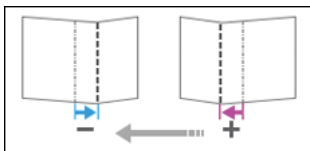

Setting Items	Default Value	Max. Value	Min. Value	Step	Unit
[A3 SEF]	0.0	1.0	-1.0	0.2	mm
[B4 JIS SEF]					
[A4 SEF]					
[B5 JIS SEF]					
[SRA3 SEF]					
[SRA4 SEF]					
[$13 \times 19^{1/5}$ SEF]					
[13×19 SEF]					
[13×18 SEF]					
[$12^{3/5} \times 19^{1/5}$ SEF]					
[$12^{3/5} \times 18^{1/2}$ SEF]					
[12×18 SEF]					
[11×17 SEF]					
[$8^{1/2} \times 14$ SEF]					
[$8^{1/2} \times 11$ SEF]					
[Other Paper Sizes]					

0620 [Paper Alignment for Booklet: Across Feed]

Adjust the width of the Staple Jogger to reduce dispersion of paper in vertical orientation due to paper size, thickness, curl and so on. Use [+] or [-] to expand or reduce the width.

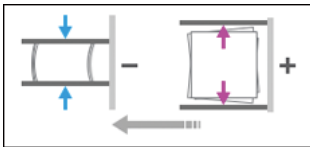

Setting Items	Default Value	Max. Value	Min. Value	Step	Unit
[A3 SEF]	0.0	0.5	-0.5	0.1	mm
[B4 JIS SEF]					
[A4 SEF]					
[B5 JIS SEF]					
[SRA3 SEF]					
[SRA4 SEF]					
[$13 \times 19^{1/5}$ SEF]					
[13×19 SEF]					
[13×18 SEF]					
[$12^{3/5} \times 19^{1/5}$ SEF]					
[$12^{3/5} \times 18^{1/2}$ SEF]					
[12×18 SEF]					
[11×17 SEF]					
[$8^{1/2} \times 14$ SEF]					
[$8^{1/2} \times 11$ SEF]					
[Other Paper Sizes]					

0621 [Set Number of Folds for Booklet]

Set no. of additional folding when using Saddle Stitching. Initial: 0, 1 - 13: 1 time, 14 - 15: 2 times, 16 - 25: 3 times. It does additional folding as per above no. plus setting value.

Setting Item	Default Value	Max. Value	Min. Value	Step	Unit
[Setting]	0	9	-3	1	time(s)

0622 [Paper Alignment for Booklet: With Feed]

Adjust movement range of Tip Stopper. It reduces dispersion of paper in horizontal orientation due to paper size, thickness, curl and so on. Use [+] or [-] to expand or reduce the width.

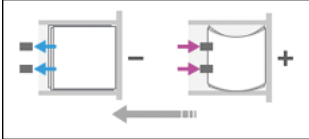

2

Setting Items	Default Value	Max. Value	Min. Value	Step	Unit
[A3 SEF]	0.0	2.0	-2.0	0.2	mm
[B4 JIS SEF]					
[A4 SEF]					
[B5 JIS SEF]					
[SRA3 SEF]					
[SRA4 SEF]					
[13 × 19 ¹ / ₅ SEF]					
[13 × 19 SEF]					
[13 × 18 SEF]					
[12 ³ / ₅ × 19 ¹ / ₅ SEF]					
[12 ³ / ₅ × 18 ¹ / ₂ SEF]					
[12 × 18 SEF]					
[11 × 17 SEF]					
[8 ¹ / ₂ × 14 SEF]					
[8 ¹ / ₂ × 11 SEF]					
[Other Paper Sizes]					

0623 [Z-fold Skew Correction]

Select way to correct skew during Z-folding. [No] makes no correction. [Yes] corrects by striking. [On: Reverse (Default)] corrects by both striking and reverse rotation of Regist. Roller.

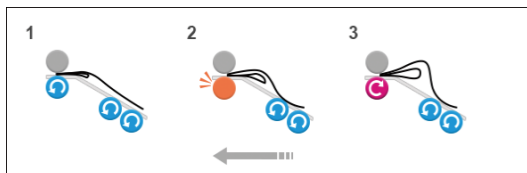

Setting Item	Values	Default Value
[Setting]	[Off] [On] [On: Reverse (Default)]	[On: Reverse (Default)]

0624 [Amount of Z-fold Skew Correction]

Adjust striking amount of paper during Z-folding skew correction. It is used when side effects occur. The initial setting of paper striking is 9mm and becomes 0mm by setting [-9].

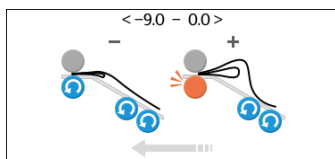

Setting Item	Default Value	Max. Value	Min. Value	Step	Unit
[Setting]	0.0	0.0	-9.0	0.5	mm

0625 [Amount of Z-fold Skew Correction: Reverse]

Adjust the reverse rotation amount of Registration Roller during Z-folding Skew Correction. It is used against side effects. The initial setting is 3mm and becomes 0mm by setting [-3].

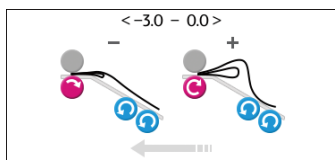

Setting Item	Default Value	Max. Value	Min. Value	Step	Unit
[Setting]	0.0	0.0	-3.0	0.5	mm

2

0626 [Maximum No. Stacked Sheets in Output Tray]

Set the number of sheets to stack on the shift tray at the time of shift sorting. To avoid paper jams, set the number proper to each paper size.

Setting Items	Default Value	Max. Value	Min. Value	Step	Unit
[Paper Length \leq 216]	0	2	0	1	None
[216<Paper Length \leq 432]					
[432<Paper Length]		1			

[Finishing: Fold]

0701 [Z-fold Position 1]

Adjust the edge of Z-folding when Z-folding is done by the Paper Folding Unit.



Setting Items	Default Value	Max. Value	Min. Value	Step	Unit
[A3 SEF]	0.0	4.0	-4.0	0.2	mm
[B4 JIS SEF]					
[A4 SEF]					
[12 × 18 SEF]					
[11 × 17 SEF]					
[8 ¹ / ₂ × 14 SEF]					
[8 ¹ / ₂ × 11 SEF]					
[8K SEF]					
[Other Paper Sizes]					

0702 [Z-fold Position 2]

Adjust the outer frame size of Z-folding when Z-folding is done by the Paper Folding Unit.

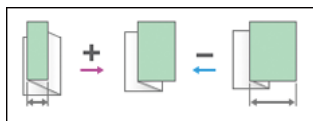

Setting Items	Default Value	Max. Value	Min. Value	Step	Unit
[A3 SEF]	0.0	4.0	-4.0	0.2	mm
[B4 JIS SEF]					
[A4 SEF]					
[12 × 18 SEF]					
[11 × 17 SEF]					
[8 ¹ / ₂ × 14 SEF]					
[8 ¹ / ₂ × 11 SEF]					
[8K SEF]					
[Other Paper Sizes]					

0703 [Half Fold Position: 1 sheet Fold]

Adjust the edge of folding when Folding in Two is done by the Paper Folding Unit. It applies when Single Folding is selected.

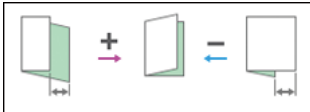

Setting Items	Default Value	Max. Value	Min. Value	Step	Unit
[A3 SEF]	0.0	4.0	-4.0	0.2	mm
[B4 JIS SEF]					
[A4 SEF]					
[B5 JIS SEF]					
[SRA3 SEF]					
[SRA4 SEF]					
[310 × 432mm SEF]					
[226 × 310mm SEF]					
[13 × 19 ¹ / ₅ SEF]					
[13 × 19 SEF]					
[13 × 18 SEF]					
[12 ³ / ₅ × 19 ¹ / ₅ SEF]					
[12 ³ / ₅ × 18 ¹ / ₂ SEF]					
[12 × 18 SEF]					
[11 × 17 SEF]					
[8 ¹ / ₂ × 14 SEF]					
[8 ¹ / ₂ × 11 SEF]					
[8K SEF]					
[Other Paper Sizes]					

0704 [Half Fold Position: Multi-sheet Fold]

Adjust the edge of folding when Folding in Two is done by the Paper Folding Unit. It applies when Overlap Folding is selected.

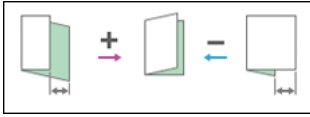

Setting Items	Default Value	Max. Value	Min. Value	Step	Unit
[A3 SEF]	0.0	4.0	-4.0	0.2	mm
[B4 JIS SEF]					
[A4 SEF]					
[B5 JIS SEF]					
[SRA3 SEF]					
[SRA4 SEF]					
[310 × 432mm SEF]					
[226 × 310mm SEF]					
[13 × 19 ¹ / ₅ SEF]					
[13 × 19 SEF]					
[13 × 18 SEF]					
[12 ³ / ₅ × 19 ¹ / ₅ SEF]					
[12 ³ / ₅ × 18 ¹ / ₂ SEF]					
[12 × 18 SEF]					
[11 × 17 SEF]					
[8 ¹ / ₂ × 14 SEF]					
[8 ¹ / ₂ × 11 SEF]					
[8K SEF]					
[Other Paper Sizes]					

0705 [Letter Fold-out Position 1: 1 sheet Fold]

Adjust the edge of folding when Outside 3 Folding is done by the Paper Folding Unit. It is applied when Single Folding is selected.

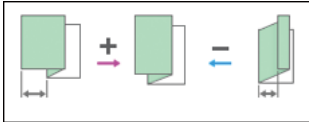

2

Setting Items	Default Value	Max. Value	Min. Value	Step	Unit
[A3 SEF]	0.0	4.0	-4.0	0.2	mm
[B4 JIS SEF]					
[A4 SEF]					
[B5 JIS SEF]		3.0	-3.0		
[12 × 18 SEF]		4.0	-4.0		
[11 × 17 SEF]					
[8 ¹ / ₂ × 14 SEF]					
[8 ¹ / ₂ × 11 SEF]					
[8K SEF]					
[Other Paper Sizes]					

0706 [Letter Fold-out Position 1: Multi-sheet Fold]

Adjust the edge of folding when Outside 3 Folding is done by the Paper Folding Unit. It is applied when Overlap Folding is selected.

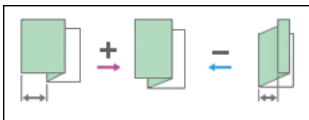

Setting Items	Default Value	Max. Value	Min. Value	Step	Unit
[B4 JIS SEF]	0.0	4.0	-4.0	0.2	mm
[A4 SEF]					
[B5 JIS SEF]		3.0	-3.0		
[8 ¹ / ₂ × 14 SEF]		4.0	-4.0		
[8 ¹ / ₂ × 11 SEF]					
[Other Paper Sizes]					

0707 [Letter Fold-out Position 2: 1 sheet Fold]

Adjust the outer frame size when Outside 3 Folding is done by the Paper Folding Unit. It is applied when Single Folding is selected.

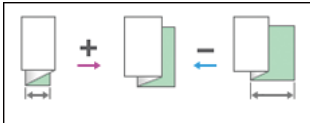

Setting Items	Default Value	Max. Value	Min. Value	Step	Unit
[A3 SEF]	0.0	4.0	-4.0	0.2	mm
[B4 JIS SEF]					
[A4 SEF]					
[B5 JIS SEF]		3.0	-3.0		
[12 × 18 SEF]		4.0	-4.0		
[11 × 17 SEF]					
[8 ¹ / ₂ × 14 SEF]					
[8 ¹ / ₂ × 11 SEF]					
[8K SEF]					
[Other Paper Sizes]					

0708 [Letter Fold-out Position 2: Multi-sheet Fold]

Adjust the outer frame size when Outside 3 Folding is done by the Paper Folding Unit. It is applied when Overlap Folding is selected.

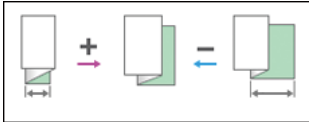

2

Setting Items	Default Value	Max. Value	Min. Value	Step	Unit		
[A3 SEF]	0.0	4.0	-4.0	0.2	mm		
[B4 JIS SEF]							
[A4 SEF]							
[B5 JIS SEF]						3.0	-3.0
[12 × 18 SEF]						4.0	-4.0
[11 × 17 SEF]							
[8 ¹ / ₂ × 14 SEF]							
[8 ¹ / ₂ × 11 SEF]							
[8K SEF]							
[Other Paper Sizes]							

0709 [Letter Fold-in Position 1: 1 sheet Fold]

Adjust the edge of folding when Inside 3 Folding is done by the Paper Folding Unit. It applies when Single Folding is selected.

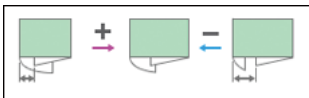

Setting Items	Default Value	Max. Value	Min. Value	Step	Unit
[A3 SEF]	0.0	4.0	-4.0	0.2	mm
[B4 JIS SEF]					
[A4 SEF]					
[B5 JIS SEF]					
[12 × 18 SEF]					
[11 × 17 SEF]					
[8 ¹ / ₂ × 14 SEF]					
[8 ¹ / ₂ × 11 SEF]					
[8K SEF]					
[Other Paper Sizes]					

0710 [Letter Fold-in Position 1: Multi-sheet Fold]

Adjust the edge of folding when Inside 3 Folding is done by the Paper Folding Unit. It applies when Overlap Folding is selected.

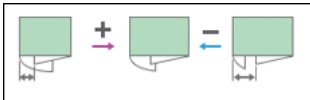

Setting Items	Default Value	Max. Value	Min. Value	Step	Unit
[A3 SEF]	0.0	4.0	-4.0	0.2	mm
[B4 JIS SEF]					
[A4 SEF]					
[B5 JIS SEF]					
[12 × 18 SEF]					
[11 × 17 SEF]					
[8 ¹ / ₂ × 14 SEF]					
[8 ¹ / ₂ × 11 SEF]					
[8K SEF]					
[Other Paper Sizes]					

0711 [Letter Fold-in Position 2: 1 sheet Fold]

Adjust the fold size when Inside 3 Folding is done by the Paper Folding Unit. It applies when Single Folding is selected.



Setting Items	Default Value	Max. Value	Min. Value	Step	Unit
[A3 SEF]	0.0	4.0	-4.0	0.2	mm
[B4 JIS SEF]					
[A4 SEF]					
[B5 JIS SEF]					
[12 × 18 SEF]					
[11 × 17 SEF]					
[8 ¹ / ₂ × 14 SEF]					
[8 ¹ / ₂ × 11 SEF]					
[8K SEF]					
[Other Paper Sizes]					

0712 [Letter Fold-in Position 2: Multi-sheet Fold]

Adjust the fold size when Inside 3 Folding is done by the Paper Folding Unit. It applies when Overlap Folding is selected.



Setting Items	Default Value	Max. Value	Min. Value	Step	Unit
[A3 SEF]	0.0	4.0	-4.0	0.2	mm
[B4 JIS SEF]					
[A4 SEF]					
[B5 JIS SEF]					
[12 × 18 SEF]					
[11 × 17 SEF]					
[8 ¹ / ₂ × 14 SEF]					
[8 ¹ / ₂ × 11 SEF]			0.0 ^{*1}		
[8K SEF]			-4.0		
[Other Paper Sizes]					

*1 If the machine in use allows -0.1 mm or less to be selected, this will be interpreted as 0.0 mm.

0713 [Double Parallel Fold Position 1]/0714 [Double Parallel Fold Position 2]

Adjust the position of the edge 1/2 when Parallel Folding is done by the Paper Folding Unit.

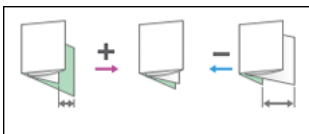

Setting Items	Default Value	Max. Value	Min. Value	Step	Unit
[A3 SEF]	0.0	4.0	-4.0	0.2	mm
[B4 JIS SEF]					
[A4 SEF]					
[B5 JIS SEF]					
[12 × 18 SEF]					
[11 × 17 SEF]					
[8 ¹ / ₂ × 14 SEF]					
[8 ¹ / ₂ × 11 SEF]					
[8K SEF]					
[Other Paper Sizes]					

0715 [Gate Fold Position 1]/0716 [Gate Fold Position 2]/0717 [Gate Fold Position 3]

Adjust the position of the edge 1/2/3 when Gate Folding is done by the Paper Folding Unit.

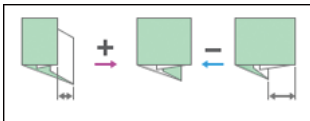
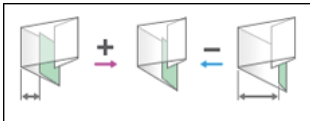
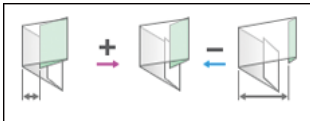

Setting Items	Default Value	Max. Value	Min. Value	Step	Unit
[A3 SEF]	0.0	4.0	-4.0	0.2	mm
[B4 JIS SEF]					
[A4 SEF]					
[B5 JIS SEF]					
[11 × 17 SEF]					
[8 ¹ / ₂ × 14 SEF]					
[8 ¹ / ₂ × 11 SEF]					
[8K SEF]					
[Other Paper Sizes]					

0718 [Folding Unit Tray Full Detection]

Set whether to detect if Folder Tray is full of output sheets. By setting to [On], it continues printing up to [Number of Sheets Folded after Full Detection], then shows a message.

Setting Item	Values	Default Value
[Setting]	[On] [Off]	[On]

0719 [Number of Sheets Folded after Full Detection]

Set number of sheets which activates message Folding Tray is full. Setting a large number delays message and raises productivity, but may cause disarrayed stack of output sheets and paper jam.

↓ Note

- If the display of the warning message is delayed, the paper delivered to the folding unit tray may not be stacked properly or the delivered paper may block the paper exit and cause subsequent paper to be misfed.

2. Details of Menu Items in Adjustment Settings for Operators

Setting Item	Default Value	Max. Value	Min. Value	Step	Unit
[Setting]	0	250	0	1	sheet(s)

[Finishing: Perfect Binder]

0801 [Perf Bind Cvr Sht Posit: Across Feed]

For Perfect Binding, correct the positional deviation in the vertical direction (top and bottom) of the front cover and middle paper bundle.

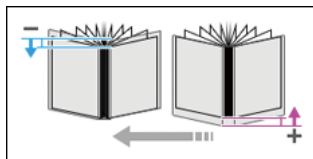

Setting Item	Default Value	Max. Value	Min. Value	Step	Unit
[Setting]	0.0	5.0	-5.0	0.1	mm

0802 [Perf Bind Cvr Sht Posit: With Feed]

Perfect Binding, correct the positional deviation in the horizontal direction (left and right) of the front cover and middle paper bundle.

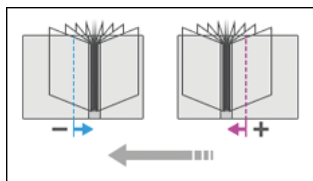

Setting Item	Default Value	Max. Value	Min. Value	Step	Unit
[Setting]	0.0	5.0	-5.0	0.1	mm

0803 [Perfect Binding Finishing Angle]

Adjust the right angle of the three sides when cutting a bundle of paper.

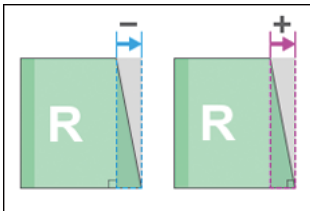
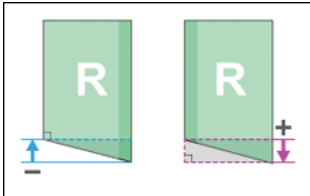
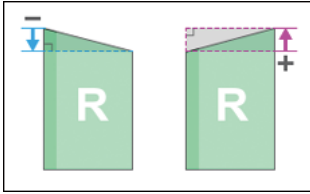

Setting Items	Default Value	Max. Value	Min. Value	Step	Unit
[Head Edge]	0.0	10.0	-10.0	0.1	mm
[Tail Edge]					
[Fore Edge]					

0804 [Applying Binding Glue]

Adjust the amount of glue for Perfect Binding.

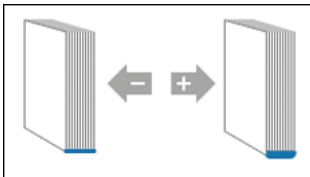

Setting Item	Default Value	Max. Value	Min. Value	Step	Unit
[Setting]	0.00	0.30	-0.30	0.05	mm

[Finishing: Stacker]

0901 [Ppr Align in Stack Tray: Acr Feed 1]

Adjust the alignment width in Main Jogger at the Stacker to reduce dispersion of sheets at right angles due to paper size, thickness, curl, etc.

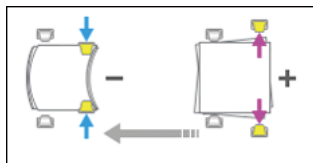

Setting Items	Default Value	Max. Value	Min. Value	Step	Unit
[A3 SEF]	0.0	1.0	-1.0	0.1	mm
[B4 JIS SEF]					
[A4 LEF]					
[A4 SEF]					
[B5 JIS LEF]					
[B5 JIS SEF]					
[A5 LEF]					
[A5 SEF]					
[11 × 17 SEF]					
[8 ¹ / ₂ × 14 SEF]					
[8 ¹ / ₂ × 11 LEF]					
[8 ¹ / ₂ × 11 SEF]					
[5 ¹ / ₂ × 8 ¹ / ₂ LEF]					
[5 ¹ / ₂ × 8 ¹ / ₂ SEF]					
[Other Paper Sizes]					

0902 [Ppr Align in Stack Tray: Acr Feed 2]

Adjust the alignment width in Sub Jogger at the Stacker to reduce dispersion of sheets at right angles due to paper size, thickness, curl, etc.

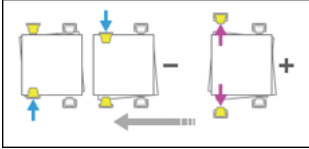

2

Setting Items	Default Value	Max. Value	Min. Value	Step	Unit
[A3 SEF]	0.0	1.0	-1.0	0.1	mm
[B4 JIS SEF]					
[11 × 17 SEF]					
[8 ¹ / ₂ × 14 SEF]					
[Other Paper Sizes]					

0903 [Paper Alignment in Stacker Tray: With Feed]

Adjust the alignment position of the Tip Stopper at the Stacker to reduce variations of paper orientation in the feeding direction due to paper size, thickness, curl, etc.

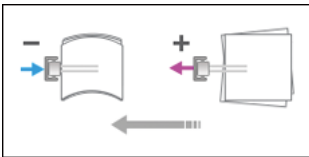

Setting Items	Default Value	Max. Value	Min. Value	Step	Unit
[A3 SEF]	0.0	1.0	-1.0	0.1	mm
[B4 JIS SEF]					
[A4 LEF]					
[A4 SEF]					
[B5 JIS LEF]					
[B5 JIS SEF]					
[A5 LEF]					
[A5 SEF]					
[11 × 17 SEF]					
[8 ¹ / ₂ × 14 SEF]					
[8 ¹ / ₂ × 11 LEF]					
[8 ¹ / ₂ × 11 SEF]					
[5 ¹ / ₂ × 8 ¹ / ₂ LEF]					
[5 ¹ / ₂ × 8 ¹ / ₂ SEF]					
[Other Paper Sizes]					

0904 [Ppr Align in 2nd Stack Tray: Acr Feed 1]

Adjust the alignment width of the Main Jogger of the Second Stacker. It reduces variations in paper orientation at right angle due to paper size, thickness, curl, etc.

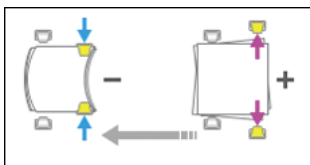

Setting Items	Default Value	Max. Value	Min. Value	Step	Unit
[A3 SEF]	0.0	1.0	-1.0	0.1	mm
[B4 JIS SEF]					
[A4 LEF]					
[A4 SEF]					
[B5 JIS LEF]					
[B5 JIS SEF]					
[A5 LEF]					
[A5 SEF]					
[11 × 17 SEF]					
[8 ¹ / ₂ × 14 SEF]					
[8 ¹ / ₂ × 11 LEF]					
[8 ¹ / ₂ × 11 SEF]					
[5 ¹ / ₂ × 8 ¹ / ₂ LEF]					
[5 ¹ / ₂ × 8 ¹ / ₂ SEF]					
[Other Paper Sizes]					

0905 [Ppr Align in 2nd Stack Tray: Acr Feed 2]

Adjust the alignment width of the Sub Jogger of the Second Stacker. It reduces variations in paper orientation at right angle due to paper size, thickness, curl, etc.

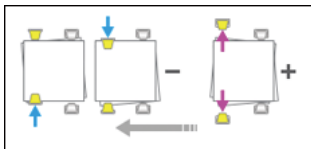

Setting Items	Default Value	Max. Value	Min. Value	Step	Unit
[A3 SEF]	0.0	1.0	-1.0	0.1	mm
[B4 JIS SEF]					
[11 × 17 SEF]					
[8 ¹ / ₂ × 14 SEF]					
[Other Paper Sizes]					

0906 [Ppr Align in 2nd Stack Tray: With Feed]

Adjust the alignment position of the Tip Stopper of the Second Stacker. It reduces variations in paper alignment in the feeding direction due to paper size, thickness, curl, etc.

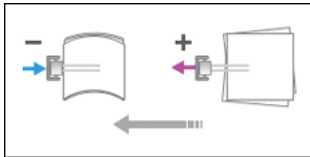

Setting Items	Default Value	Max. Value	Min. Value	Step	Unit
[A3 SEF]	0.0	1.0	-1.0	0.1	mm
[B4 JIS SEF]					
[A4 LEF]					
[A4 SEF]					
[B5 JIS LEF]					
[B5 JIS SEF]					
[A5 LEF]					
[A5 SEF]					
[11 × 17 SEF]					
[8 ¹ / ₂ × 14 SEF]					
[8 ¹ / ₂ × 11 LEF]					
[8 ¹ / ₂ × 11 SEF]					
[5 ¹ / ₂ × 8 ¹ / ₂ LEF]					
[5 ¹ / ₂ × 8 ¹ / ₂ SEF]					
[Other Paper Sizes]					

0907 [Maximum Stack Quantity in Stacker Tray]

Set the upper limit of the stacking capacity of the stacker tray common to the First and Second Stackers. It gives a warning message when it detects the tray is full.

Setting Items	Selections	Default Value
[Large Size]	[100%] [75%] [50%] [25%]	[100%]

Setting Items	Selections	Default Value
[Small Size]	[100%] [75%] [50%] [25%]	[50%]

[Density Difference Printing: Across Feed]

To reduce vertical image density differences, load 18 sheets of paper with a minimum of 279 mm/420 mm long in the tray.

Perform this adjustment only if the image density difference across the feed direction are noticeable when:

- Replacing the photoconductor unit or charger unit
- Changing 0520 [Special Toner Position] from [Print Special Toner First] to [Print Special Toner Last]

1. Make sure you have at least 18 sheets of A3 or larger paper.

Paper of the following attributes is supported:

- Size: regular-size paper of 279.4-330.2 mm wide and 420-487.68 mm long (banner sheets are not supported.)
- Paper type:

	Basis weight	Smoothness	Whiteness
Coated: Glossy	73.3-250 g/m ²	8,000 sec or less	82-95%
Coated: Matte			
Plain Paper	100-209.3 g/m ²	50 sec or more	

2. Load paper into all paper trays except Tray 1.

3. Press [Density Difference Printing: Across Feed].

The machine prints 16 image-adjustment sheets.

At the same time, the TIM-Mag unit scans the adjustment images and calculates the laser intensity adjustment value.

4. After two image-adjustment sheets are printed, press [Apply].



If you do not apply the adjustment value, press [Stop].

↓ Note

- It is not required to perform this adjustment every time you change paper.
- Performing this adjustment repeatedly will not remove image density differences. Perform this only once when image density differences are noticeable.
- If black streaks appear after this adjustment is performed, clean the surface of the TIM-Mag unit exposure glass and the shading correction plate of the revolver. For details, see "Cleaning the TIM-Mag Unit", Maintenance and Management.
- This function is unavailable when 0520 [Special Toner Position] is set to [Print Special Toner First].
- This function does not support special colors.

3. Custom Paper Settings for Administrators

Accessing Advanced Settings

1. Press "Login/Logout" () on the top right of the screen.
The name that appears lower the "Login/Logout" icon depends on the type of administrator logging in.
2. Enter your login user name and password, and then press [Login].
If you are logging on as the administrator for the first time, enter "admin".
3. Press [Tray Paper Settings] at the upper left of the screen.
4. Press [CustomPaper Management].
5. Select the program number of the custom paper profile you wish to adjust.
6. Press edit  icon.
7. Press [Advanced Settings].
The advanced settings for custom paper adjustment appear.

Description of Paper Icons

You can check the custom paper status by checking the paper icon in the [CustomPaper Management] screen. If you change the custom paper profile in the advanced settings, the paper icon changes as follows:

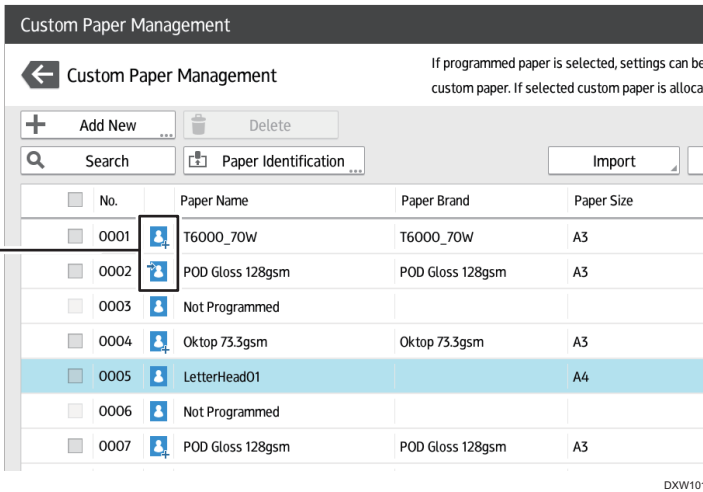

1. Paper icon

	Not adjusted	Custom paper profile set to the default setting in the advanced settings
	Adjusted	Custom paper profile changed from the default setting in the advanced settings

↓ Note

- If you specify a custom paper profile in the [CustomPaper Management] screen without registering it from the paper library, the paper icon will not appear for that custom paper profile.
- If you change the custom paper profile from the default setting in the advanced settings, and then change the setting back to the default again, the paper icon will remain as "Adjusted".

Deleting Saved Custom Paper Profiles

Only the machine administrator can delete the custom paper profile saved in the paper library.

1. Press "Login/Logout" () on the top right of the screen.

The name that appears lower the "Login/Logout" icon depends on the type of administrator logging in.

2. Enter your login user name and password, and then press [Login].

If you are logging on as the administrator for the first time, enter "admin".

3. Press [Tray Paper Settings] at the upper left of the screen.

4. Press [CustomPaper Management].

5. Select the program number of the custom paper profile you wish to delete.

If the custom paper you want to select is not displayed, scroll through the screen until the desired item is displayed.

6. Press [Delete].

7. Press [OK].

The custom paper profile is deleted.

8. Press [].

9. Press the [Home] () icon at the center bottom of the screen.



Backing up and Restoring Custom Paper Profiles

Backing up Custom Paper Profiles Registered Under the [CustomPaper Management] Setting

3

The machine administrator can save all types of registered custom paper to the paper library in an SD card at one time.

Backing up the Data

1. Press [Tray Paper Settings] in the upper left corner of the screen.
2. Press [CustomPaper Management].
3. Insert an SD card into the media slot.
For details about using an SD card, see "Inserting an SD Card", Preparation.
4. Press [Export].
5. Press [OK].
6. Press [Exit].
7. Press [].
8. Press the [Home] () icon at the center bottom of the screen.

Restoring the Data

1. Press [Tray Paper Settings] in the upper left corner of the screen.
2. Press [CustomPaper Management].
3. Insert the SD card containing the backup custom paper profiles into the SD card slot on the side of the control panel.
4. Press [Import] and select [From SD Card] from the dropdown menu.
5. Select the name of the paper that you want to register.

Select an item by selecting its check box.

If the paper you want to select is not displayed, use [Jump to Row], or scroll through the screen until the desired item is displayed.

You can select two or more types of paper.

6. Press [Import].
7. Press [OK].
8. Press [Exit].

9. Press [].

10. Press the [Home] () icon at the center bottom of the screen.

 **Note**

- Up to 1,000 custom papers can be saved in the library.
- Each saved custom paper is assigned a sequential number from 0001. New data overwrites existing data if both the paper names and paper size settings are the same.

Backing up and Restoring Custom Paper Profiles Using the External Controller's Control Panel

3

Using the external controller's control panel, you can back up and restore custom paper profiles associated with the external controller's paper catalog data. For details, see the external controller's instruction manual.

Paper Presets in "Advanced Settings"

In "Advanced Settings", there are paper presets for various types of commercially-available paper. Even if you select a paper preset corresponding to a commercially-available paper from the Paper Library and register it in the [CustomPaper Management] screen, the preset, depending on the custom paper profile version, may not be an exact match for the actual paper.

Displaying the Paper Profile Version

3

This section explains how to display the version of the custom paper profiles registered in the [CustomPaper Management] screen. For details about updating paper profiles, contact your service representative.

1. Press "Login/Logout" (👤) on the top right of the screen.
The name that appears lower the "Login/Logout" icon depends on the type of administrator logging in.
2. Enter your login user name and password, and then press [Login].
If you are logging on as the administrator for the first time, enter "admin".
3. Press [Tray Paper Settings] at the upper left of the screen.
4. Press [CustomPaper Management].
5. Select the program number of a custom paper profile to display the product name of the supported paper type and the paper profile version.
6. Press edit (✎) icon.
7. Press [Paper Brand].

The screenshot shows the 'Custom Paper Management' interface. At the top, there's a title bar with 'Custom Paper Management' and a 'Save Paper' button. Below the title bar, there's a 'Check / Change Settings' section with a 'Scan the Value' button and an 'Update the Value' button. A table lists paper profile details:

Paper Brand	Oktop 73.3gsm
Manufacturer	Oji Seishi
Paper Name	Oktop 73.3gsm
Paper Size	A3
Paper Weight	63.1 - 80.0 gsm
Paper Thickness	-
Paper Type	Plain Paper

To the right of the table is an 'Advanced Settings' section with a 'Check the paper brand.' label and a text area displaying 'Oktop 73.3gsm Ver. 0'. A 'Save Paper' button is also visible at the top right of the main content area.

The product name of the supported paper type and the paper profile version appear.

4. Details of Menu Items in Advanced Settings

[Machine: Image Position]

1101 [Image Position]

[Image Position: Side 1]/[Image Position: Side 2]

Adjust the vertical/horizontal position of the image to be printed on side 1/2 of the paper.

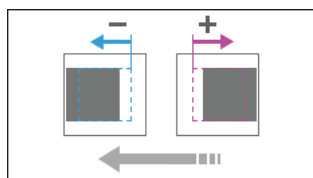
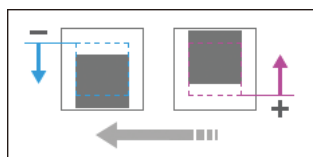

Setting Item	Max. Value	Min. Value	Step	Unit
01: Across Feed/02: With Feed/03: Across Feed/04: With Feed	3.00	-3.00	0.01	mm

[Image Position: Adjust Front & Back]

Adjust the registration to align the image of side 2 to the image of side 1. The value set here is added to the value of [Image Position: Side 2].

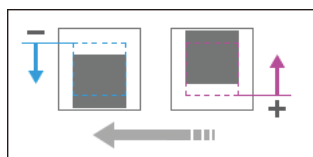

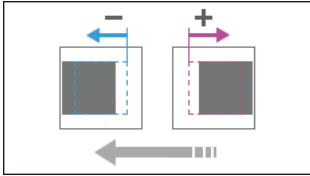

Setting Item	Max. Value	Min. Value	Step	Unit
05: Across Feed/06: With Feed	3.00	-3.00	0.01	mm

[Image Magnification: Side 1]/[Image Magnification: Side 2]

4

Adjust the vertical/horizontal image scaling on the side 1/2 of the paper according to the paper expansion or shrinkage.

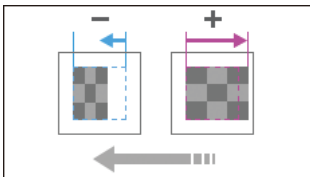
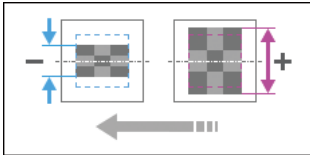

Setting Item	Max. Value	Min. Value	Step	Unit
07: Across Feed/09: Across Feed	0.500	-0.500	0.001	%
08: With Feed/10: With Feed			0.025	

[Image Magnification: Adjust Front & Back]

Adjust the vertical/horizontal image scaling to align the image of side 2 to the image of side 1. The value set here is added to the value of [Image Magnification: Side 2].

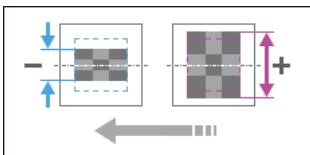

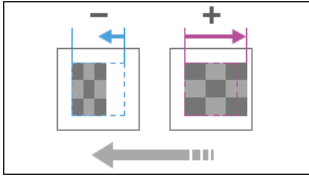

Setting Item	Max. Value	Min. Value	Step	Unit
11: Across Feed	0.500	-0.500	0.001	%
12: With Feed			0.025	

[Trapezoidal Distortion: Side 1]/[Trapezoidal Distortion: Side 2]

4

Adjust the perpendicularity (image magnification of trailing edge with across feed direction) of side 1/2.

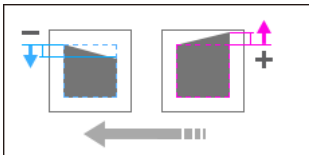
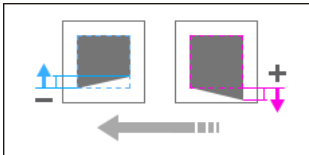

Setting Item	Max. Value	Min. Value	Step	Unit
13: Operator Side/14: Opposite Side of Operator/15: Operator Side/16: Opposite Side of Operator	0.250	-0.250	0.001	%

[Trapezoidal Distortion: Adjust Front & Back]

Adjust the trapezoidal deviation to align the image of side 2 to the image of side 1. The value set here is added to the value of [Trapezoidal Distortion: Side 2].

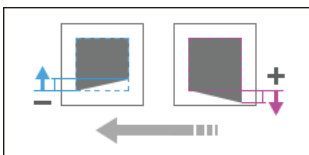

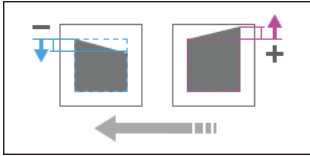

Setting Item	Max. Value	Min. Value	Step	Unit
17: Operator Side/18: Opposite Side of Operator	0.250	-0.250	0.001	%

4

[Switch Paper Edge Detection Sensor]

Select accuracy of paper edge detection sensor to correct image position in feeding direction. Select [Normal] if paper jam(J031) occurs when the paper other than white is fed.

Setting Item	Values
19: Setting	[Normal] [High Accuracy]

1102 [Auto Adjust Image Position]

[No. of Check Sheets]

Set the number of check sheets to be printed when Auto Adjust Image Position is executed.

Setting Item	Max. Value	Min. Value	Step	Unit
01: Front Side/02: Front & Back Sides	100	1	1	None

[Adjustment Mode]

Set the accuracy when Auto Adjust Image Position is executed.

Setting Item	Values
03: Setting	[Normal] [High Accuracy]

1103 [Image Position Feedback Correction]

[Correction Mode]

Select the mode for Image Position Feedback Correction. If [Detection Mark] is selected, a mark will be printed on each corner of the page. Select [Correction Off] if marks are not required.

Setting Item	Values
01: Setting	[1: Correction Off] [2: Detection Mark: Back] [3: Detection Mark: Front & Back]

4

1104 [Image Position Feedback Correction: Gap]

[Image Position: Side 1]/[Image Position: Side 2]

Fine-adjust the correction amount for Image Position Feedback Correction (Side 1/2).

Setting Item	Max. Value	Min. Value	Step	Unit
01: Across Feed/02: With Feed/03: Across Feed/04: With Feed	3.00	-3.00	0.01	mm

[Image Magnification: Side 1]/[Image Magnification: Side 2]

Fine-adjust the correction amount of magnification for Image Position Feedback Correction (Side 1/2).

Setting Item	Max. Value	Min. Value	Step	Unit
05: Across Feed/07: Across Feed	0.500	-0.500	0.001	%
06: With Feed/08: With Feed			0.025	

[Trapezoidal Distortion: Side 1]/[Trapezoidal Distortion: Side 2]

Fine-adjust the magnification of trailing edge with across feed direction for Image Position Feedback Correction (Side 1/2).

4. Details of Menu Items in Advanced Settings

Setting Item	Max. Value	Min. Value	Step	Unit
09: Left Edge/10: Right Edge/11: Left Edge/12: Right Edge	0.250	-0.250	0.001	%

[Machine: Image Quality]

1201 [Max Image Density]

Adjust the maximum image density for each color.

Setting Item	Max. Value	Min. Value	Step	Unit
01: Black/02: Cyan/03: Magenta/04: Yellow/05: Clear/Special/06: White	5	-5	1	None

1212 [Image Transfer Output]

[BW]

Under the following conditions, adjust the output of the image transfer.

Black & White Printing

Setting Item	Max. Value	Min. Value	Step	Unit
01: Black	10	-10	1	None

[FC/FCS]

Under the following conditions, adjust the output of the image transfer for each color.

Full Color Printing/Full Color Printing including Special Color

Setting Item	Max. Value	Min. Value	Step	Unit
02: Black/03: Cyan/04: Magenta/05: Yellow/06: Clear/Special/07: White	10	-10	1	None

[S]

Under the following conditions, adjust the output of the image transfer.

Printing using Special Color Only

Setting Item	Max. Value	Min. Value	Step	Unit
10: Clear/Special/11: White	10	-10	1	None

1214 [Paper Transfer Output]

[BW]

Under the following conditions, adjust the paper transfer output.

Black & White Printing

Setting Item	Max. Value	Min. Value	Step	Unit
01: Side 1/02: Side 2	10	-10	1	None

[FC/FCS]

Under the following conditions, adjust the paper transfer output.

Full Color Printing/Full Color Printing including Special Color

High Quality is not applied in DFE Setting

Setting Item	Max. Value	Min. Value	Step	Unit
03: Side 1/04: Side 2	10	-10	1	None

[FCS]

Under the following conditions, adjust the paper transfer output.

Full Color Printing including Special Color

High Quality is applied in DFE Setting

Setting Item	Max. Value	Min. Value	Step	Unit
05: Side 1/06: Side 2	10	-10	1	None

[S]

Under the following conditions, adjust the paper transfer output.

Printing using Special Color Only

Setting Item	Max. Value	Min. Value	Step	Unit
07: Side 1: Clear/Special/08: Side 1: White/11: Side 2: Clear/Special/12: Side 2: White	10	-10	1	None

1216 [Paper Transfer Output Correction: Paper Edge]

[BW]

Under the following conditions, adjust the correction amount and range of paper transfer output for leading and trailing edge.

Black & White Printing

Setting Item	Max. Value	Min. Value	Step	Unit
01: Leading Edge/02: Trailing Edge	10	-10	1	None
03: Leading Edge Length	30	0	1	mm
04: Trailing Edge Length	100	0	1	mm

[FC/FCS]

Under the following conditions, adjust the correction amount and range of paper transfer output for leading and trailing edge.

Full Color Printing/Full Color Printing including Special Color

Setting Item	Max. Value	Min. Value	Step	Unit
05: Leading Edge/06: Trailing Edge	10	-10	1	None
07: Leading Edge Length	30	0	1	mm
08: Trailing Edge Length	100	0	1	mm

[S]

Under the following conditions, adjust the correction amount and range of paper transfer output for leading and trailing edge.

Printing using Special Color Only

Setting Item	Max. Value	Min. Value	Step	Unit
09: Leading Edge: Clear/Sp/10: Leading Edge: White/13: Trailing Edge: Clear/Sp/14: Trailing Edge: White	10	-10	1	None
17: Leading Edge Len.: Clr/Sp/18: Leading Edge Len.: White	30	0	1	mm
21: Trailing Edge Len.: Clr/Sp/22: Trailing Edge Len.: White	100	0	1	mm

4 1218 [Paper Transfer Output: Textured Paper Mode]

Set Textured Paper Mode. Textured Paper Mode can be adjusted when [On] is selected.

Setting Item	Values
01: Setting	[Off] [On]

[BW]

Under the following conditions, adjust the paper transfer output.

Textured Paper Mode is enabled

Black & White Printing

Setting Item	Max. Value	Min. Value	Step	Unit
02: Side 1/03: Side 2	10	-10	1	None

[FC/FCS]

Under the following conditions, adjust the paper transfer output.

Textured Paper Mode is enabled FC/FC with S

High Quality is not applied in DFE Setting

Setting Item	Max. Value	Min. Value	Step	Unit
04: Side 1/05: Side 2	10	-10	1	None

[FCS]

Under the following conditions, adjust the paper transfer output.

Textured Paper Mode is enabled Full Color including Special

High Quality is applied in DFE Setting

Setting Item	Max. Value	Min. Value	Step	Unit
06: Side 1/07: Side 2	10	-10	1	None

[S]

Under the following conditions, adjust the paper transfer output.

Textured Paper Mode is enabled

Printing using Special Color Only

Setting Item	Max. Value	Min. Value	Step	Unit
08: Side 1: Clear/Special/09: Side 1: White/12: Side 2: Clear/Special/13: Side 2: White	10	-10	1	None

1221 [Paper Transfer Separate Voltage]

Adjust the paper transfer separate voltage.

Setting Item	Max. Value	Min. Value	Step	Unit
01: Side 1/02: Side 2	10	-10	1	None

1222 [Paper Transfer Nip Operation Mode]

Adjust shock when paper fed through PTRoller. Higher value (1->4) higher reduction. Leading edge density may be less.

* Low pressure mode can be used only for the job using one paper type.

Setting Item	Values
01: Setting	[Off] [Mode 1] [Mode 2] [Mode 3] [Mode 4] [Low Pressure Mode]

1223 [Paper Transfer Nip]

[Nip Setting]

Adjust setting below when Paper Transfer Nip Operation Mode is set.

Timing of contact & disengage of paper transfer roller/Gap of disengagement/Reduced pressure when low pressure mode is set

Setting Item	Max. Value	Min. Value	Step	Unit
02: On Timing	5	-30	1	step
03: Off Timing	0	-100	1	step
04: Adjust Gap	40	12	1	step
05: Pressure Reduced	44	4	1	step

1231 [Print Speed]

[BW/FC/FCS]

Under the following conditions, set the print speed.

Black & White Printing/Full Color Printing/Full Color Printing including Special Color

High Quality is not applied in DFE Setting

Setting Item	Values
01: BW/FC/FCS	[High] [Middle] [Low]

[FCS]

Under the following conditions, set the print speed.

Full Color Printing including Special Color

High Quality is applied in DFE Setting

Setting Item	Values
02: Clear/Special/03: White	[High] [Middle] [Low]

[S]

Under the following conditions, set the print speed.

Printing using Special Color Only

High Quality is applied in DFE Setting

Setting Item	Values
06: Clear/Special/07: White	[High] [Middle] [Low]

[BW/FC/FCS: Fuser Setting HQ]

Under the following conditions, set the print speed.

Black & White Printing/Full Color Printing/Full Color Printing including Special Color

High Quality is not applied in DFE Setting

Setting Item	Values
10: BW/FC/FCS	[High] [Middle] [Low]

[FCS: Fuser Setting HQ]

Under the following conditions, set the print speed.

Full Color Printing including Special Color

High Quality is applied in DFE Setting

4

Setting Item	Values
11: Clear/Special/12: White	[High] [Middle] [Low]

[S: Fuser Setting HQ]

Under the following conditions, set the print speed.

Printing using Special Color Only

High Quality is applied in DFE Setting

Setting Item	Values
15: Clear/Special/16: White	[High] [Middle] [Low]

1232 [Fusing Temperature]

[BW/FC/FCS]

Under the following conditions, adjust heat roller temperature, temperature correction, initial sheet interval.

B & W/Full Color/Full Color with Special

High Quality is not applied in DFE Setting

Setting Item	Max. Value	Min. Value	Step	Unit
01: Heat Roller Temp	200	100	1	deg
02: Corct Temp: Initial Feed/03: Corct Temp: Pre-Feed	30	0	1	deg
04: Initial Print Interval: Low/05: Initial Print Interval	3	0	1	None

[FCS]

Under the following conditions, adjust heat roller temperature, temperature correction, and initial sheet interval.

Full Color Printing including Special

High Quality is applied in DFE Setting

Setting Item	Max. Value	Min. Value	Step	Unit
06: Heat Roller Temp: Clr/Sp/07: Heat Roller Temp: White	200	100	1	deg
10: Corct Temp: Init Fd: Clr/Sp/11: Corct Temp: Init Fd: White/14: Corct Temp: Pre-Fd: Clr/Sp/15: Corct Temp: Pre-Fd: White	30	0	1	deg
18: Init Sht Intvl: Low: Clr/Sp/19: Init Sht Intvl: Low: White/22: Init Sht Intvl: Clr/Sp/23: Init Sht Intvl: White	3	0	1	None

[S]

Under the following conditions, adjust heat roller temperature, temperature correction, and initial sheet interval.

Printing using Special Color Only

High Quality is applied in DFE Setting

Setting Item	Max. Value	Min. Value	Step	Unit
26: Heat Roller Temp: Clr/Sp/27: Heat Roller Temp: White	200	100	1	deg

Setting Item	Max. Value	Min. Value	Step	Unit
30: Corct Temp: Init Fd: Clr/Sp/31: Corct Temp: Init Fd: White/34: Corct Temp: Pre-Fd: Clr/Sp/35: Corct Temp: Pre-Fd: White	30	0	1	deg
38: Init Sht Intvl: Low: Clr/Sp/39: Init Sht Intvl: Low: White/42: Init Sht Intvl: Clr/Sp/43: Init Sht Intvl: White	3	0	1	None

[BW/FC/FCS: Fuser Setting HQ]

4

Under the following conditions, adjust heat roller temperature, temperature correction, initial sheet interval.

B & W/Full Color/Full Color including Special

High Quality is not applied in DFE Setting

Setting Item	Max. Value	Min. Value	Step	Unit
46: Heat Roller Temp	200	100	1	deg
47: Corct Temp: Initial Feed/48: Corct Temp: Pre-Feed	30	0	1	deg
49: Initial Sheet Interval: Low/50: Initial Sheet Interval	3	0	1	None

[FCS: Fuser Setting HQ]

Under the following conditions, adjust heat roller temperature, temperature correction, and initial sheet interval.

Full Color Printing including Special

High Quality is applied in DFE Setting

Setting Item	Max. Value	Min. Value	Step	Unit
51: Heat Roller Temp: Clr/Sp/52: Heat Roller Temp: White	200	100	1	deg
55: Corct Temp: Init Fd: Clr/Sp/56: Corct Temp: Init Fd: White/59: Corct Temp: Pre-Fd: Clr/Sp/60: Corct Temp: Pre-Fd: White	30	0	1	deg

Setting Item	Max. Value	Min. Value	Step	Unit
63: Init Sht Intvl: Low: Clr/Sp/64: Init Sht Intvl: Low: White/67: Init Sht Intvl: Clr/Sp/68: Init Sht Intvl: White	3	0	1	None

[S: Fuser Setting HQ]

Under the following conditions, adjust heat roller temperature, temperature correction, and initial sheet interval.

Printing using Special Color Only

High Quality is applied in DFE Setting

Setting Item	Max. Value	Min. Value	Step	Unit
71: Heat Roller Temp: Clr/Sp/72: Heat Roller Temp: White	200	100	1	deg
75: Corct Temp: Init Fd: Clr/Sp/76: Corct Temp: Init Fd: White/79: Corct Temp: Pre-Fd: Clr/Sp/80: Corct Temp: Pre-Fd: White	30	0	1	deg
83: Init Sht Intvl: Low: Clr/Sp/84: Init Sht Intvl: Low: White/87: Init Sht Intvl: Clr/Sp/88: Init Sht Intvl: White	3	0	1	None

1233 [Fusing Pressure Temperature]

[BW/FC/FCS]

Under the following conditions, adjust pressure roller temperature.

Black & White Printing /Full Color Printing/Full Color Printing including Special

High Quality is not applied in DFE Setting

Setting Item	Max. Value	Min. Value	Step	Unit
01: Press Rlr Temp: BW/FC/FCS	200	50	1	deg

[FCS/S]

Under the following conditions, adjust pressure roller temperature.

Full Color Printing including Special Color

High Quality is applied in DFE Setting

Setting Item	Max. Value	Min. Value	Step	Unit
02: Press Rlr Temp:Clr/Sp/03: Press Rlr Temp: White	200	50	1	deg

4

1234 [Print Mode When Switching Paper Type]

Adjust the waiting time when switching the paper in a job with mixed paper. [Productivity Priority] raises the productivity, however the fusing quality may be reduced.

Setting Item	Values
01: Setting	[Use Operator Adjustment Settings] [Fusing Priority] [Standard] [Productivity Priority]

1235 [Fusing Temperature Range]

[BW/FC/FCS]

Under conditions below, set range of fusing start temperature.

B&W/FC/FC with S

HQ is not applied in DFE

The lager value becomes, the earlier print starts. However, fusing quality may become lower.

Setting Item	Max. Value	Min. Value	Step	Unit
01: Level: BW/FC/FCS	16	1	1	None

[FCS]

Under conditions below, set range of fusing start temperature.

FC with S

HQ is applied in DFE Setting

The larger value becomes, the earlier printing starts. However, fusing quality may become lower.

Setting Item	Max. Value	Min. Value	Step	Unit
02: Level: Clear/Special/03: Level: White	16	1	1	None

[S]

Under conditions below, set range of fusing start temperature. Print using S

Only HQ is applied in DFE

The larger value becomes, the earlier print starts. However, fusing quality may become lower.

Setting Item	Max. Value	Min. Value	Step	Unit
06: Level: Clear/Special/07: Level: White	16	1	1	None

[BW/FC/FCS: Fuser Setting HQ]

Under conditions below, set range of fusing start temperature.

B&W/FC/FC with S

HQ is not applied in DFE

The larger value becomes, the earlier print starts. However, fusing quality may become lower.

Setting Item	Max. Value	Min. Value	Step	Unit
10: Level: BW/FC/FCS	16	1	1	None

[FCS: Fuser Setting HQ]

Under conditions below, set range of fusing start temperature.

FC with S HQ is applied in DFE Setting

The larger value becomes, the earlier printing starts. However, fusing quality may become lower.

Setting Item	Max. Value	Min. Value	Step	Unit
11: Level: Clear/Special/12: Level: White	16	1	1	None

[S: Fuser Setting HQ]

Under conditions below, set range of fusing start temperature.

Print using S Only

HQ is applied in DFE

The lager value becomes, the earlier print starts. However, fusing quality may become lower.

Setting Item	Max. Value	Min. Value	Step	Unit
15: Level: Clear/Special/16: Level: White	16	1	1	None

4

1236 [Fusing Pressure Roller Cooling]

[BW/FC/FCS]

Under the following conditions, set the cooling fan level of pressure roller.

Black & White/Full Color/Full Color including Special Color

High Quality is not applied in DFE Setting

Setting Item	Max. Value	Min. Value	Step	Unit
01: Fan Level: BW/FC/FCS	6	0	1	None

[FCS/S]

Under the following conditions, set the cooling fan level of pressure roller.

Full Color Printing including Special Color

High Quality is applied in DFE Setting

Setting Item	Max. Value	Min. Value	Step	Unit
01: Fan Level: Clear/Special/02: Fan Level: White	6	0	1	None

1237 [Print Speed (Sheet Interval Adj)]

[BW/FC/FCS]

Under the following conditions, adjust the print speed by widening sheet interval.

Black & White/Full Color/Full Color including Special

High Quality is not applied in DFE Setting

Setting Item	Max. Value	Min. Value	Step	Unit
01: BW/FC/FCS	100	1	1	%

[FCS]

Under the following conditions, adjust the print speed by widening sheet interval.

Full Color Printing including Special Color

High Quality is applied in DFE Setting

Setting Item	Max. Value	Min. Value	Step	Unit
02: Clear/Special/03: White	100	1	1	%

1238 [Fusing Cleaning]

[BW/FC/FCS]

Under the following conditions, adjust the frequency of the pressure roller cleaning.

Black & White/Full Color/Full Color including Special

High Quality is not applied in DFE Setting

Setting Item	Values
01: Cleaning Interval: BW/FC/FCS	[Normal] [Frequently] [More Frequently] [Most Frequently]

[FCS/S]

Under the following conditions, adjust the frequency of the pressure roller cleaning.

Full Color Printing including Special Color

High Quality is applied in DFE Setting

Setting Item	Values
02: Cleaning Interval: Clr/Sp/03: Cleaning Interval: White	[Normal] [Frequently] [More Frequently] [Most Frequently]

4

1239 [Erase Margin]

[BW/FC/FCS/S]

Under the following conditions, adjust margin (mask width) of leading/trailing edge of image.

High Quality is not applied in DFE Setting

Setting Item	Max. Value	Min. Value	Step	Unit
01: Leading Edge/02: Trailing Edge	6.0	0.0	0.1	mm

[FCS]

Under the following conditions, adjust margin (mask width) of leading/trailing edge of image.

Full Color including Special

High Quality is applied in DFE Setting

Setting Item	Max. Value	Min. Value	Step	Unit
03: Leading Edge: Clr/Sp/04: Leading Edge: White/07: Trailing Edge: Clr/Sp/08: Trailing Edge: White	6.0	0.0	0.1	mm

1240 [Fusing Nip Width: Paper Type]

Select the paper type.

Setting Item	Values
01: Type	[Other than Envelope] [Envelope]

1241 [Fusing Nip Width Adjustment]

Adjust the contact width (nip width) between fusing belt and pressure roller.

Setting Item	Max. Value	Min. Value	Step	Unit
02: Other than Envelope	4	1	1	None
03: Envelope	20000	0		μm

4

1242 [Initial Fusing Temperature for Envelope]

Before the envelope is printed, stabilize the nip width to reduce the wrinkles of the paper. It may take 3 minutes.

Setting Item	Values
01: Setting	[Off] [On]

1243 [Fusing Belt Smoothing]

Adjust the interval to execute the auto smoothing fusing belt. Select a higher frequency for greater smoothness, this may reduce the life of the smoothing roller.

Setting Item	Values
01: For Uneven Gloss (Short Time)/02: For Belt Scratches	[Normal] [Frequently] [More Frequently] [Most Frequently]

1244 [Fusing Pressure Roller On Before Fusing]

Turn on or off pressurization when the feed speed of the fusing belt is adjusted before paper is fed.

Setting Item	Values
01: Pressure	[Off] [On]

[Machine: Paper Feed/ Output]

1301 [2-Tray LCIT: Paper Feed Mode]

Adjust the fan operation if double feed or nonfeed occurs in 2-Tray LCIT.

Setting Item	Values
01: Paper Feed Mode:Fan Level	[Prevent Double Feed (Weakest Blow)] [Prevent Double Feed (Weaker Blow)] [Standard (Default)] [Prevent Non Feed (Stronger Blow)] [Prevent Non Feed (Strongest Blow)]

4

1302 [2-Tray LCIT: Fan/Shutter]

[Updraft Fan Level]

Under conditions below, adjust updraft fan operation in 2-Tray LCIT. Increase the air volume with [+], and decrease it with [-]. [S: - 150/L: 150.1 mm -] [s: - 148/m: 148.1 - 487.7/l: 487.8mm -]

Setting Item	Max. Value	Min. Value	Step	Unit
01: Size: Across: S/ Feed: s/02: Size: Across: S/ Feed: m/03: Size: Across: S/ Feed: l/04: Size: Across: L/ Feed: s/05: Size: Across: L/ Feed: m/06: Size: Across: L/ Feed: l	100	0	10	%

[Blower Fan Level]

Under conditions below, adjust blower fan operation in 2-Tray LCIT. Increase the air volume with [+], and decrease it with [-]. [S: - 150/L: 150.1 mm -] [s: - 148/m: 148.1 - 487.7/l: 487.8mm -]

Setting Item	Max. Value	Min. Value	Step	Unit
07: Size: Across: S/ Feed: s/08: Size: Across: S/ Feed: m/09: Size: Across: S/ Feed: l/10: Size: Across: L/ Feed: s/11: Size: Across: L/ Feed: m/12: Size: Across: L/ Feed: l	100	0	10	%

[Side Fan Level]

Under conditions below, adjust side fan operation in 2-Tray LCIT. Increase the air volume with [+], and decrease it with [-]. [S: - 150/L: 150.1 mm -] [s: - 148/m: 148.1 - 487.7/l: 487.8mm -]

4

Setting Item	Max. Value	Min. Value	Step	Unit
13: Size: Across: S/ Feed: s/14: Size: Across: S/ Feed: m/15: Size: Across: S/ Feed: l/16: Size: Across: L/ Feed: s/17: Size: Across: L/ Feed: m/18: Size: Across: L/ Feed: l	100	0	10	%

[Vacuum Fan Level]

Under conditions below, adjust vacuum fan operation in 2-Tray LCIT. Increase the air volume with [+], and decrease it with [-]. [S: - 150/L: 150.1 mm -] [s: - 148/m: 148.1 - 487.7/l: 487.8mm -]

Setting Item	Max. Value	Min. Value	Step	Unit
19: Size: Across: S/ Feed: s/20: Size: Across: S/ Feed: m/21: Size: Across: S/ Feed: l/22: Size: Across: L/ Feed: s/23: Size: Across: L/ Feed: m/24: Size: Across: L/ Feed: l	100	0	10	%

[Return Fan Level]

Under conditions below, adjust return fan operation in 2-Tray LCIT. Increase the air volume with [+], and decrease it with [-]. [S: - 150/L: 150.1 mm -] [s: - 148/m: 148.1 - 487.7/l: 487.8mm -]

Setting Item	Max. Value	Min. Value	Step	Unit
25: Size: Across: S/ Feed: s/26: Size: Across: S/ Feed: m/27: Size: Across: S/ Feed: l/28: Size: Across: L/ Feed: s/29: Size: Across: L/ Feed: m/30: Size: Across: L/ Feed: l	100	0	10	%

[Updraft Fan Shutter]

Turn on or off the updraft fan shutter in Main Tray and 2-Tray LCIT. If [On] is set, the shutter operates according to the paper fed timing. [Off] enables constant operation of the fan.

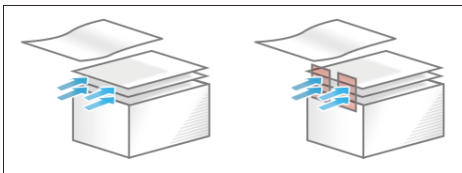

Setting Item	Values
31: Setting	[Off] [On]

[Return Fan Shutter]

Turn on or off the return fan shutter in 2-Tray LCIT. If [On] is set, the fan operates according to the paper fed timing. [Off] disables the fan operation.

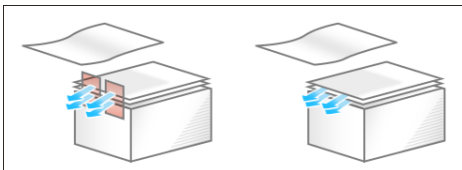

Setting Item	Values
33: Setting	[Off] [On]

[Vacuum Fan Shutter]

Turn on or off the vacuum fan shutter in 2-Tray LCIT. If [On] is set, the fan operates according to the paper fed timing. [Off] enables constant operation of the fan.

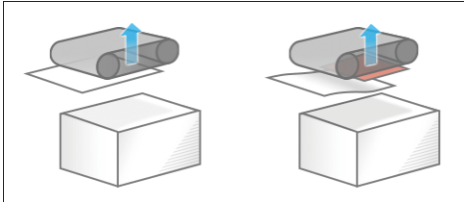

4

Setting Item	Values
34: Setting	[Off] [On]

1303 [2-Tray LCIT: Other Settings]

Adjust feed timing by setting wait time of blowing to float paper in 2-Tray LCIT.

* If double feed occurs at the start of the job, set a longer time for waiting.

Setting Item	Max. Value	Min. Value	Step	Unit
36: Paper Floating Wait Time	5.0	3.0	0.1	sec

1311 [3-Tray LCIT]

[Fan Setting]

Set the fan operation of 3-Tray LCIT. If [On] is set, the air is blown out from the duct in the paper tray. Blowing on the paper edge makes paper part easily.

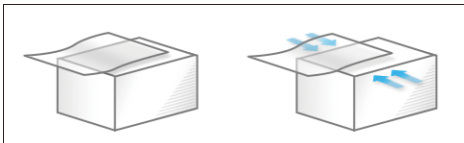

Setting Item	Values
01: Setting	[Off] [On]

[Fan Level]

Adjust the fan level of 3-Tray LCIT to make paper part easily. Increase the air volume with [+], and decrease it with [-].

Setting Item	Max. Value	Min. Value	Step	Unit
02: Setting	100	10	10	%

4

1312 [Main/3-Tray LCIT/Bypass]

[Pickup Assist]

Set the operation of the paper feed roller of Main Tray, Bypass Tray, and 3-Tray LCIT. If [On] is set, contact time of the roller is extended according to the paper type and paper weight.

Setting Item	Values
01: Setting	[Off] [On]

1321 [Correct Paper Curl]

Select the mode and amount of curl correction for output paper.

Setting Item	Values
01: Correction Mode	[1: U Curl Correction Level: Off] [2: U Curl Correction Level: Small] [3: U Curl Correction Level: Large] [4: Π Curl Correction Level: Off] [5: Π Curl Correction Level: Small] [6: Π Curl Correction Level: Large]

[Speed Adjustment]

Adjust the decurler speed according to the selected correction mode in Correct Paper Curl.

Setting Item	Max. Value	Min. Value	Step	Unit
02: Decurler: Correction Off/03: Decurler: Correction Weak/04: Decurler: Correction Strong	7.5	-1.0	0.5	%

1331 [Jam Detection]

4

[JAM080/097/098/099]

Turn on/off detect function for the following jam. J080(gap: feed)/J097(gap: across)/J098(skew)/J099(double feed) Correction for image position gap with across & skew are also turned on/off.

Setting Item	Values
01: Detect JAM080/02: Detect/Ctrl JAM097/098/03: Detect JAM099	[Off] [On]

[JAM097/098 Detect Threshold]

Set the threshold value which will determine whether a jam has occurred for JAM097 (image position gap with across feed) and JAM098 (skew).

Setting Item	Max. Value	Min. Value	Step	Unit
04: JAM097	10.0	0.0	0.1	mm
05: JAM098	7.5	1.6	0.1	mm

[Paper Edge Detection]

Set the illumination level of the image sensor for Image Position Feedback Correction: Gap with Across Feed and Skew Correction.

Setting Item	Max. Value	Min. Value	Step	Unit
06: Setting	5	1	1	None

[Registration Gate Home Position]

Adjust optimum value to increase the accuracy of Skew Correction depending on paper weight. If the image is highly skewed, adjust the value to [+] direction for thin paper, [-] direction for thick paper.

Setting Item	Max. Value	Min. Value	Step	Unit
07: Setting	8	8	1	None

1341 [Motor Speed]

[Speed Adjustment]

Adjust the speed of each motor.

Setting Item	Max. Value	Min. Value	Step	Unit
01: Transfer Timing Roller	3.00	-3.00	0.01	%
02: Paper Transfer Roller	1.50	-1.50	0.01	%
03: Trans-Fusing Transfer Belt	5.0	-5.0	0.1	%
04: Fusing Belt	10.0	-10.0	0.1	%
05: Cooling Roller After Fusing/06: Paper Output: Diversion Roller/07: Paper Output: Diversion Roller	5.0	-5.0	0.1	%
08: Switchback: Entrance Roller/09: Switchback: Exit Roller	3.0	-3.0	0.1	%

MEMO

