



User Guide

What You Can Do with This Machine	1
Getting Started	2
Copy	3
Print	4
Scan	5
Document Server	6
Web Image Monitor	7
Adding Paper and Toner	8
Troubleshooting	9
Information for This Machine	10



TABLE OF CONTENTS

How to Read the Manuals.....	7
Symbols Used in the Manuals.....	7
Symbols Used in the Manuals.....	7
Model-Specific Information.....	9
Names of Major Features.....	10

1. What You Can Do with This Machine

Searching by What You Want to Do.....	11
Reducing my Costs.....	11
Using Scanned Files on the Computer.....	12
Registering Destinations.....	13
Operating the Machine More Effectively.....	13
What You Can Do with This Machine.....	15
Customizing the [Home] Screen.....	15
Making Copies Using Various Functions.....	16
Printing Data Using Various Functions.....	17
Utilizing Stored Documents.....	17
Connecting Two Machines for Copying.....	18
Using the Scanner in a Network Environment.....	19
Embedding Text Information in Scanned Files.....	20
Preventing Information Leakage (Security Functions).....	21
Centrally Controlling Scan Conditions and Distribution.....	21
Monitoring and Setting the Machine Using a Computer.....	22
Preventing Unauthorized Copying.....	23
Using the Application Site.....	24

2. Getting Started

Guide to Names and Functions of Components.....	25
Guide to Functions of the Attention Light.....	28
Guide to Functions of the Machine's Options.....	30
Guide to Functions of the Machine's External Options.....	30
Guide to the Names and Functions of the Machine's Control Panel (When Using the Standard Operation Panel).....	41
Guide to the Names and Functions of the Machine's Control Panel (When Using the Smart Operation Panel).....	44

Changing the Display Language (When Using the Standard Operation Panel).....	45
Changing the Display Language (When Using the Smart Operation Panel).....	46
How to Use the [Home] Screen (When Using the Standard Operation Panel).....	47
Displaying the [Home] Screen (When Using the Standard Operation Panel).....	47
How to Use the [Top] Screen and the [Home] Screen (When Using the Standard Operation Panel).....	48
Adding Icons to the [Home] Screen (When Using the Standard Operation Panel).....	50
How to Use the [Home] Screen (When Using the Smart Operation Panel).....	56
Main Icons on the [Home] Screen (When Using the Smart Operation Panel).....	58
Possible Operations on the Screen (When Using the Smart Operation Panel).....	59
Adding Icons to the [Home] Screen (When Using the Smart Operation Panel).....	61
How to Use Each Application.....	64
How to Use Each Application (When Using the Standard Operation Panel).....	64
How to Use Each Application (When Using the Smart Operation Panel).....	64
[Copy] Screen (When Using the Smart Operation Panel).....	65
[Scanner] Screen (When Using the Smart Operation Panel).....	67
Registering Functions in a Program (When Using the Standard Operation Panel).....	73
Example of Programs (When Using the Standard Operation Panel).....	75
Registering Functions in a Program (When Using the Smart Operation Panel).....	78
Example of Programs (When Using the Smart Operation Panel).....	81
Turning On/Off the Power.....	85
Turning On the Main Power.....	85
Turning Off the Main Power.....	85
Logging In the Machine.....	87
When the Authentication Screen is Displayed.....	87
User Code Authentication Using the Control Panel.....	87
Logging In Using the Control Panel (When Using the Standard Operation Panel).....	87
Logging In Using the Control Panel (When Using the Smart Operation Panel).....	88
Logging Out Using the Control Panel (When Using the Standard Operation Panel).....	89
Logging Out Using the Control Panel (When Using the Smart Operation Panel).....	89
Placing Originals.....	90
Placing Originals on the Exposure Glass.....	90
Placing Originals in the Auto Document Feeder.....	90

3. Copy

Basic Procedure.....	93
Basic Procedure (Classic).....	93
Auto Reduce / Enlarge.....	95
Procedure for Auto Reduce / Enlarge (Classic).....	96
Duplex Copying.....	98
Procedure for Duplex Copying (Classic).....	100
Specifying the Original and Copy Orientation.....	100
Combined Copying.....	103
One-Sided Combine.....	104
Two-Sided Combine.....	106
Copying onto Custom Size Paper.....	109
Procedure for Copying onto Custom Size Paper (Classic).....	110
Copying onto Envelopes.....	111
Procedure for Copying onto Envelopes from the Bypass Tray (Classic).....	112
Procedure for Copying onto Envelopes from the Paper Tray or the Wide LCT (Classic).....	112
Sort.....	114
Procedure for Sort (Classic).....	115
Changing the Number of Sets.....	116
Storing Data in the Document Server.....	118

4. Print

Quick Install.....	119
Displaying the Printer Driver Properties.....	120
Standard Printing.....	121
When Using the PCL 6 Printer Driver.....	121
Printing on Both Sides of Sheets.....	122
When Using the PCL 6 Printer Driver.....	122
Types of Two-sided Printing.....	122
Combining Multiple Pages into Single Page.....	123
When Using the PCL 6 Printer Driver.....	123
Types of Combine Printing.....	123
Printing on Envelopes.....	125
Configuring Envelope Settings Using the Control Panel.....	125

Printing on Envelopes Using the Printer Driver.....	126
Saving and Printing Using the Document Server.....	127
Storing Documents in Document Server.....	127
Managing Documents Stored in Document Server.....	128
Using the Quick Print Release Function (When Using the Smart Operation Panel).....	129
Using the Print/Scan (Memory Storage Device) Function (When Using the Smart Operation Panel)..	130

5. Scan

Basic Procedure When Using Scan to Folder.....	133
Basic Procedure When Using Scan to Folder (Classic).....	133
Creating a Shared Folder on a Computer Running Windows/Confirming a Computer's Information.....	135
Registering an SMB Folder.....	137
Deleting an SMB Registered Folder.....	140
Entering the Path to the Destination Manually.....	141
Basic Procedure for Sending Scan Files by E-mail.....	143
Basic Procedure for Sending Scan Files by E-mail (Classic).....	143
Registering an E-mail Destination.....	145
Deleting an E-mail Destination.....	147
Entering an E-mail Address Manually.....	148
Basic Procedure for Storing Scan File.....	149
Checking a Stored File Selected from the List.....	150
Specifying the File Type.....	152
Procedure for Specifying the File Type (Classic).....	153
Specifying Scan Settings.....	154
Procedure for Specifying Scan Settings (Classic).....	154

6. Document Server

Storing Data.....	157
Printing Stored Documents.....	159

7. Web Image Monitor

Displaying Top Page.....	161
--------------------------	-----





8. Adding Paper and Toner

Loading Paper.....	163
Precautions for Loading Paper.....	163

Loading Paper into Tray 1.....	165
Loading Paper into the A3/11 × 17 Tray Unit.....	167
Loading Paper into Trays 2 and 3.....	168
Loading Paper into the Bypass Tray.....	172
Loading Paper into the Large Capacity Tray.....	178
Loading Paper into the Wide Large Capacity Tray.....	179
Loading Paper into the Interposer.....	183
Loading Paper into the Twin Interposer.....	184
Loading Orientation-fixed Paper or Two-sided Paper.....	186
Recommended Paper.....	189
Recommended Paper Sizes and Types.....	189
Registering a Custom Paper with the Media Identification Unit.....	213
Part Names and Functions of the Media Identification Unit.....	213
Connect the Media Identification Unit.....	213
How to Register Paper Scanned by the Media Identification Unit as Custom Paper.....	214
Adding Toner.....	222
Sending scanned documents when toner has run out.....	224
Disposing of used toner.....	224
Menu Items and Functions.....	226
9. Troubleshooting	
When a Status Icon Is Displayed.....	229
When the Indicator Lamp for the [Check Status] Key Is Lit or Flashing.....	231
When the Machine Makes a Beeping Sound.....	234
When You Have Problems Operating the Machine.....	235
When Multiple Functions Cannot Be Executed Simultaneously.....	241
Messages Displayed When You Use the Copy/Document Server Function.....	243
When Using the Connect Copy Function.....	246
Messages Displayed When You Use the Printer Function.....	248
Messages Displayed on the Control Panel When You Use the Printer Function.....	248
Messages Printed on the Error Logs or Reports When You Use the Printer Function.....	251
Messages Displayed When You Use the Scanner Function.....	263
Messages Displayed on the Control Panel When You Use the Scanner Function.....	263
Messages Displayed on the Client Computer.....	273

When Other Messages Appear.....	280
When There Is a Problem Scanning or Storing Originals.....	281
When the Home Screen Cannot Be Edited (When Using the Standard Operation Panel).....	282
When the Address Book Is Updated.....	283
When Data Cannot Be Sent Due to a Problem with the Destination.....	284
When the Machine Cannot Be Operated Due to a Problem with the User Certificate.....	284
When Problems Occur While Logging In.....	286
When the User Lacks Privileges to Perform an Operation.....	286
When the LDAP Server Cannot Be Used.....	286

10. Information for This Machine

Information on Environmental Regulations.....	289
ENERGY STAR Program.....	289
Energy Saving Functions.....	289
User Information on Electrical and Electronic Equipment  Region A (mainly Europe).....	292
Note for the Battery and/or Accumulator Symbol (For EU countries only)  Region A (mainly Europe)	293
Environmental Advice for Users  Region A (mainly Europe).....	293
Notes to users in the state of California (Notes to Users in USA)  Region B (mainly North America)....	294
INDEX	295

How to Read the Manuals

Symbols Used in the Manuals

This manual uses the following symbols:

 **Important**

Indicates points to pay attention to when using the machine, and explanations of likely causes of paper misfeeds, damage to originals, or loss of data. Be sure to read these explanations.

 **Note**

Indicates supplementary explanations of the machine's functions, and instructions on resolving user errors.

 **Reference**

This symbol is located at the end of sections. It indicates where you can find further relevant information.

[]

Indicates the names of keys on the machine's display or control panels.

 **Region A** (mainly Europe and Asia), (mainly Europe), or (mainly Asia)

 **Region B** (mainly North America)

Differences in the functions of Region A and Region B models are indicated by two symbols. Read the information indicated by the symbol that corresponds to the region of the model you are using. For details about which symbol corresponds to the model you are using, see page 9 "Model-Specific Information".

Symbols Used in the Manuals

This manual uses the following symbols:

 **Important**

Indicates points to pay attention to when using the machine, and explanations of likely causes of paper misfeeds, damage to originals, or loss of data. Be sure to read these explanations.

 **Note**

Indicates supplementary explanations of the machine's functions, and instructions on resolving user errors.

 **Reference**

This symbol is located at the end of sections. It indicates where you can find further relevant information.

[]

Indicates the names of keys on the machine's display or control panels.

 **Region A** (mainly Europe and Asia), (mainly Europe), or (mainly Asia)

 **Region B** (mainly North America)

Differences in the functions of Region A and Region B models are indicated by two symbols. Read the information indicated by the symbol that corresponds to the region of the model you are using. For details about which symbol corresponds to the model you are using, see page 9 "Model-Specific Information".

Model-Specific Information

This section explains how you can identify the region your machine belongs to.

There is a label on the rear of the machine, located in the position shown below. The label contains details that identify the region your machine belongs to. Read the label.

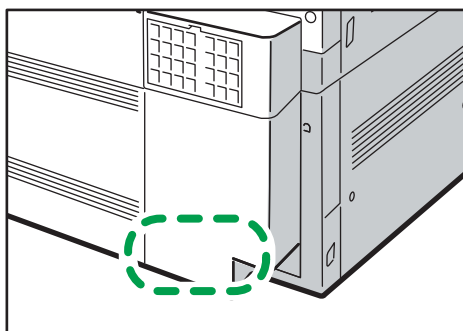

DRC101

The following information is region-specific. Read the information under the symbol that corresponds to the region of your machine.

Region **A** (mainly Europe)

If the label contains the following, your machine is a region A model:

- CODE XXXX -27
- 220–240 V

Region **B** (mainly North America)

If the label contains the following, your machine is a region B model:

- CODE XXXX -17
- 208–240 V

Note

- Dimensions in this manual are given in two units of measure: metric and inch. If your machine is a Region A model, refer to the metric units. If your machine is a Region B model, refer to the inch units.

Names of Major Features

In this manual, major features of the machine are referred to as follows:

- Auto Document Feeder → ADF
- LCIT RT4020 → Large Capacity Tray (LCT)
- $8\frac{1}{2} \times 14$ PAPER SIZE TRAY TYPE M2 → Extension unit
- LCIT RT4050 → Wide Large Capacity Tray (Wide LCT)
- Multi-Folding Unit FD4000 → Multi-folding unit
- Decurler Unit DU5020 → Decurler unit

1. What You Can Do with This Machine

You can search for a description by what you want to do. Also, this machine's distinctive functions are explained.

Searching by What You Want to Do

You can search for a procedure by what you want to do.

Reducing my Costs

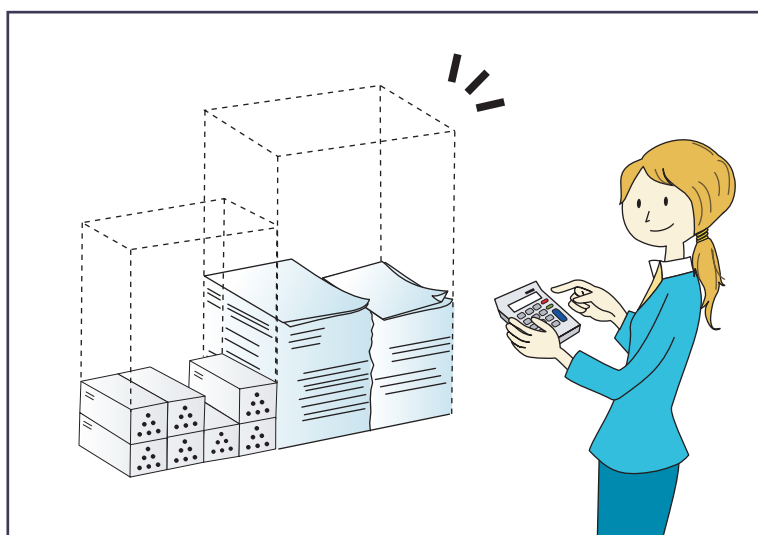

BRL059S

Printing multi-page documents on both sides of sheets (Duplex Copy)

⇒ See "Duplex Copying", Copy/ Document Server.

Printing multi-page documents on a single sheet (Combine)

⇒ See "Combined Copying", Copy/ Document Server.

Checking how much paper is saved ([Information] screen)

⇒ See "[Information] Screen (When Using the Standard Operation Panel)", Getting Started.

⇒ See "[Information] Screen (When Using the Smart Operation Panel)", Getting Started.

Reducing electricity consumption

⇒ See "Saving Energy", Getting Started.

⇒ See "Timer Settings", Connecting the Machine/ System Settings.

Using Scanned Files on the Computer

1

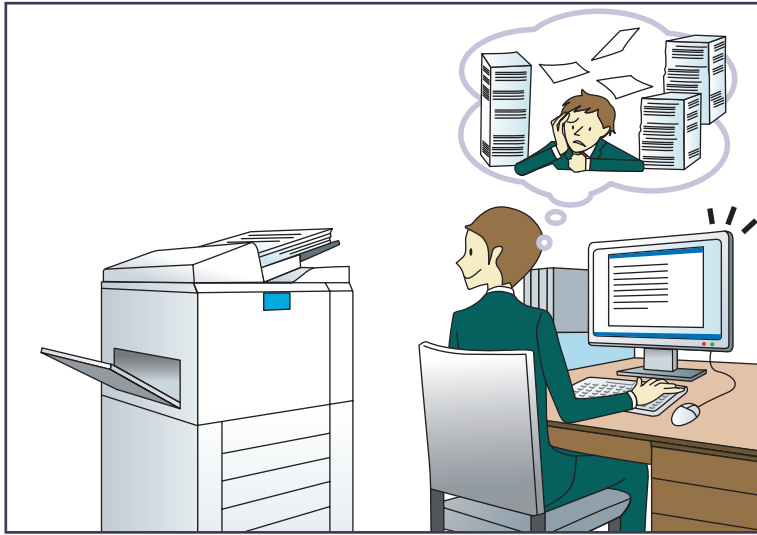

BQX138S

Sending scan files

⇒ See "Basic Procedure for Sending Scan Files by E-mail", Scan.

Sending the URL of the folder in which scan files are stored

⇒ See "Sending the URL by E-mail", Scan.

Storing scan files in a shared folder

⇒ See "Basic Procedure When Using Scan to Folder", Scan.

Storing scan files on media

⇒ See "Basic Procedure for Saving Scan Files on a Memory Storage Device", Scan.

Embedding text information in scanned files

⇒ See "Embedding Text Information in Scanned Data", Scan.

Managing and using documents converted to electronic formats (Document Server)

⇒ See "Relationship between Document Server and Other Functions", Copy/ Document Server.

Registering Destinations

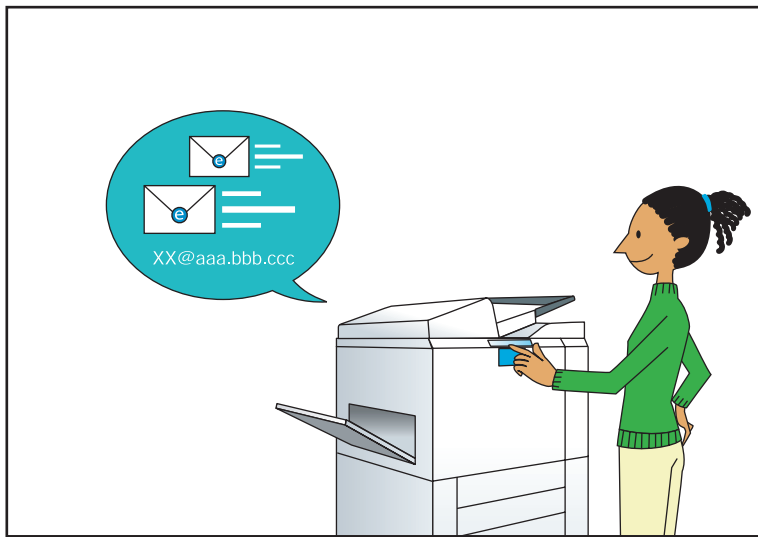

CAY062

Using the control panel to register destinations in the Address Book

⇒ See "Procedure for registering a destination in the address book manually (classic)", Scan.

Operating the Machine More Effectively



BQX139S

Registering and using frequently-used settings (Program)

⇒ See "Registering Functions in a Program (When Using the Standard Operation Panel)", Convenient Functions.

⇒ See "Registering Functions in a Program (When Using the Smart Operation Panel)", Convenient Functions.

Registering frequently-used settings as initial settings (Program as Defaults)

⇒ See "Changing the Default Functions of the Initial Screen", Convenient Functions.

Registering frequently-used printing settings to the printer driver

⇒ See "Using One Click Presets", Print.

Changing the initial settings of the printer driver to frequently-used printing settings

⇒ See "Displaying the [Printing Preferences] Dialog Box", Print.

Adding shortcuts to frequently used programs

⇒ See "Adding Icons to the [Home] Screen (When Using the Standard Operation Panel)", Convenient Functions.

⇒ See "Adding Icons to the [Home] Screen (When Using the Smart Operation Panel)", Convenient Functions.

Changing the order of the function and shortcut icons

⇒ See "Changing the Order of Icons on the [Home] Screen (When Using the Standard Operation Panel)", Convenient Functions.

⇒ See "Changing the Order of Icons on the [Home] Screen (When Using the Smart Operation Panel)", Convenient Functions.

What You Can Do with This Machine

This section describes the features of this machine.

1

Customizing the [Home] Screen

The icons of each function are displayed on the [Home] screen.

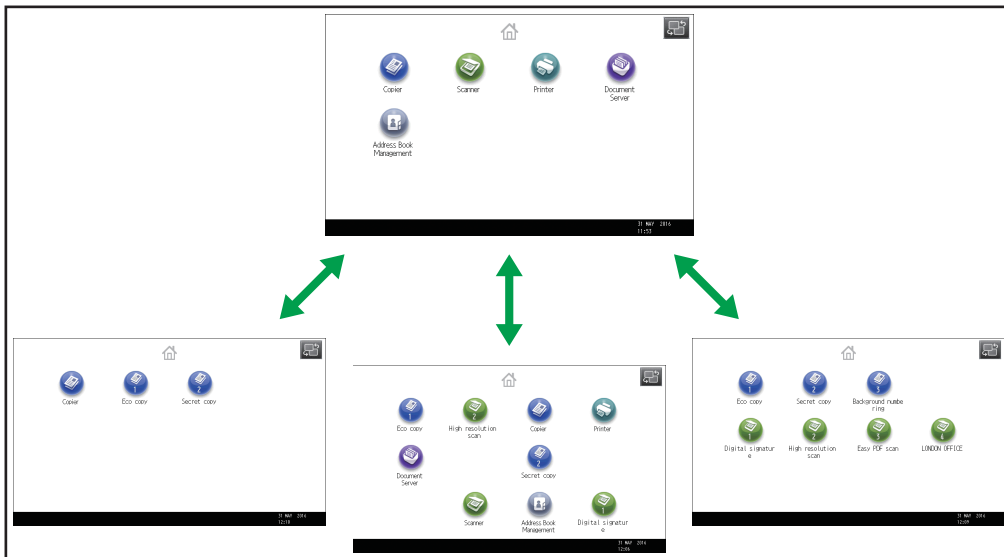

DRC141

- You can add shortcuts to often used programs to the [Home] screen. The programs can be recalled easily by pressing the shortcut icons.
- You can display only the icons of functions and shortcuts that you use.
- You can change the order of the function and shortcut icons.

Reference

- For details about the features on the [Home] screen, see "How to Use the [Home] Screen (When Using the Standard Operation Panel)" and "How to Use the [Home] Screen (When Using the Smart Operation Panel)", *Getting Started*.
- For details about how to customize the [Home] screen, see "Customizing the [Home] Screen (When Using the Standard Operation Panel)" and "Customizing the [Home] Screen (When Using the Smart Operation Panel)", *Convenient Functions*.

Making Copies Using Various Functions

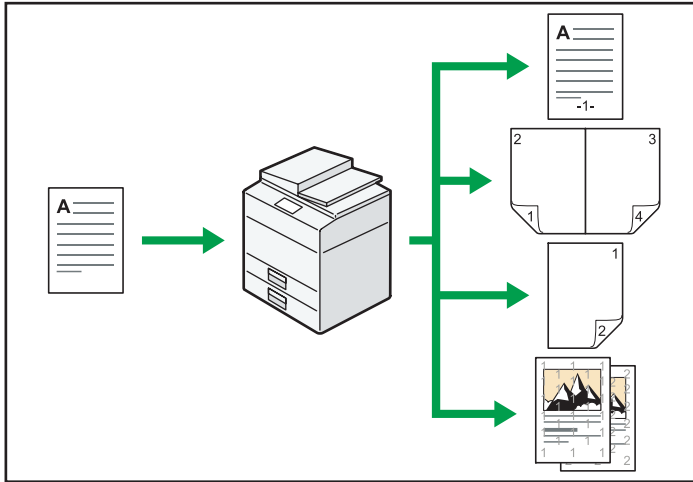

CJ0601

- You can make copies in full color. You can switch the color copy mode depending on the type of originals used and the desired finish.
⇒ See "Copying in Color", Copy/ Document Server.
- You can print stamps on copies. Stamps can include background numbers, scanned images, dates, text, and page numbers.
⇒ See "Stamps", Copy/ Document Server.
- You can adjust the color tones and image quality of your copies.
⇒ For details about a color adjustment, see "Adjusting Color", Copy/ Document Server.
⇒ For details about an image adjustment, see "Image Adjustment", Copy/ Document Server.
- You can reduce or enlarge the copy image. Auto Reduce / Enlarge function enables the machine to detect the original size automatically. Also, it enables the machine to select an appropriate reproduction ratio based on the paper size you specify. If the orientation of the original is different from that of the paper you are copying onto, the machine rotates the original image by 90 degrees to match it with the copy paper.
⇒ See "Reducing or Enlarging Originals", Copy/ Document Server.
- Copier functions such as Duplex, Combine, Booklet, and Magazine allow you to save on paper by copying multiple pages onto single sheets.
⇒ For details about duplex copying, see "Duplex Copying", Copy/ Document Server.
⇒ For details about combined copying, see "Combined Copying", Copy/ Document Server.
⇒ For details about the booklet and magazine functions, see "Booklet/Magazine", Copy/ Document Server.
- You can copy onto various types of paper such as envelopes and transparencies.

- ⇒ See "Copying onto Various Types of Paper", Copy/ Document Server.
- The finisher allows you to sort, staple, and punch holes in your copies.
 - ⇒ See "Finishing", Copy/ Document Server.

Printing Data Using Various Functions

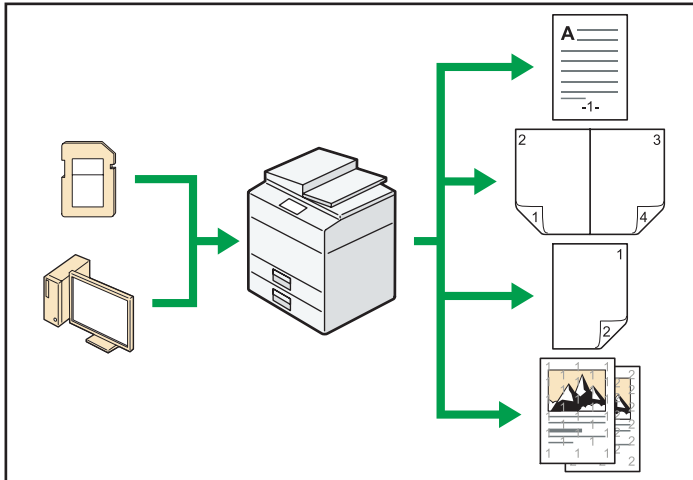

CJ0614

- This machine supports network and local connections.
- You can print or delete print jobs stored on the machine's hard disk, which have been previously sent from computers using the printer driver. The following types of print jobs can be selected: Sample Print, Locked Print, Hold Print, and Stored Print.
 - ⇒ See "Storing Documents in the Hard Disk Drive and Printing Them", Print.
- The finisher allows you to collate, staple, and punch holes in your prints.
 - ⇒ For details about stapling, see "Staple", Print.
 - ⇒ For details about punching, see "Punch", Print.
- You can print files stored on a removable memory device and specify print conditions such as print quality and print size.
 - ⇒ See "Direct Printing from a Memory Storage Device", Print.

Utilizing Stored Documents

You can store files scanned in copier, printer, or scanner mode on the machine's hard disk. Web Image Monitor allows you to use your computer to search for, view, print, delete, and send stored files via the network. You can also change print settings and print multiple documents (Document Server).

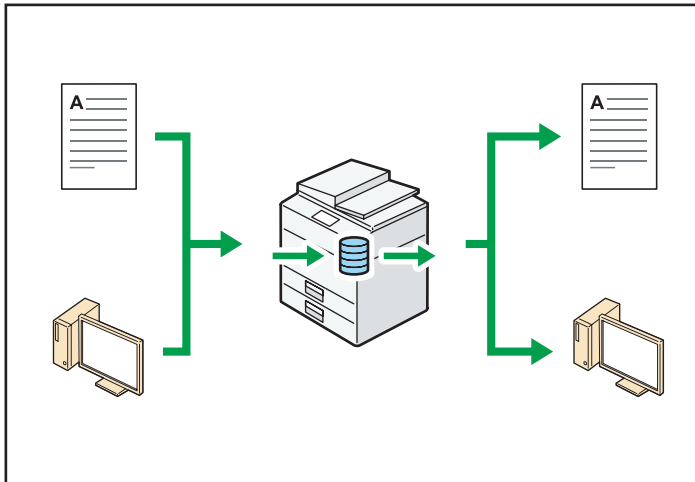

CUM004

- You can retrieve stored documents scanned in scanner mode to your computer.
- Using the file format converter, you can download documents stored in copier, Document Server, or printer mode to your computer.

Reference

- For details about how to use the Document Server, "Storing Data in the Document Server", Copy/ Document Server.
- For details about the Document Server in copier mode, see "Document Server", Copy/ Document Server.
- For details about the Document Server in printer mode, see "Saving and Printing Using the Document Server", Print.
- For details about the Document Server in scanner mode, see "Storing and Saving the Scanned Documents", Scan.

Connecting Two Machines for Copying

You can connect two machines together with copy connector. When you set up a copy job on one machine (the main machine), data is transferred to the other (the sub-machine) so that copies can be made on both machines simultaneously (Connect Copy).

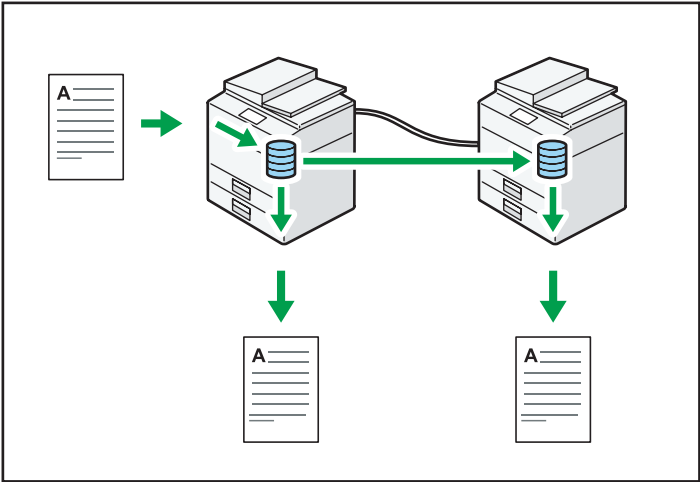

CJQ101

- You can complete large volume copy runs in shorter time.
- Even if one machine runs out of paper, or stops because of a paper jam, the other machine can still continue to finish the job.

Reference

- See "Connect Copying", Print.

Using the Scanner in a Network Environment

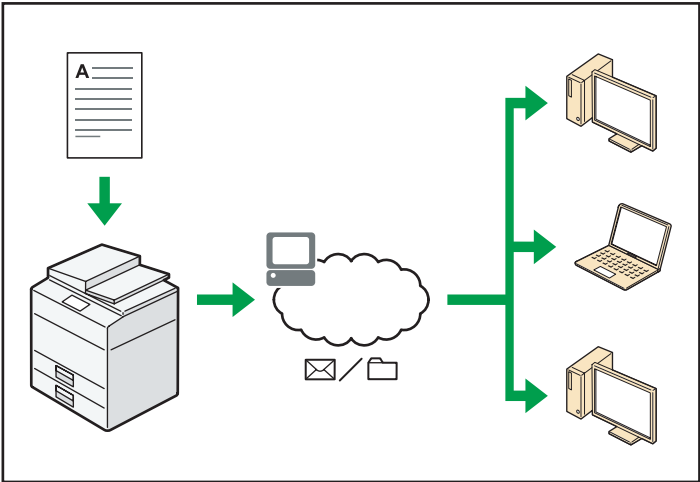

CJQ607

- You can send scan files to a specified destination using e-mail (Sending scan files by e-mail).
⇒ See "Basic Procedure for Sending Scan Files by E-mail", Scan.
- You can send scan files directly to folders (Sending scan files by Scan to Folder).

⇒ See "Basic Procedure When Using Scan to Folder", Scan.

- You can use Web Services on Devices (WSD) to send scan files to a client computer.

⇒ See "Basic Operating Procedure of WSD Scanner (Push Type)", Scan.

Embedding Text Information in Scanned Files

You can extract text information from a scanned document and embed it in the file without using a computer.

If you scan a document using this function, embedded text can be searched by using the text search function or copied to another document.

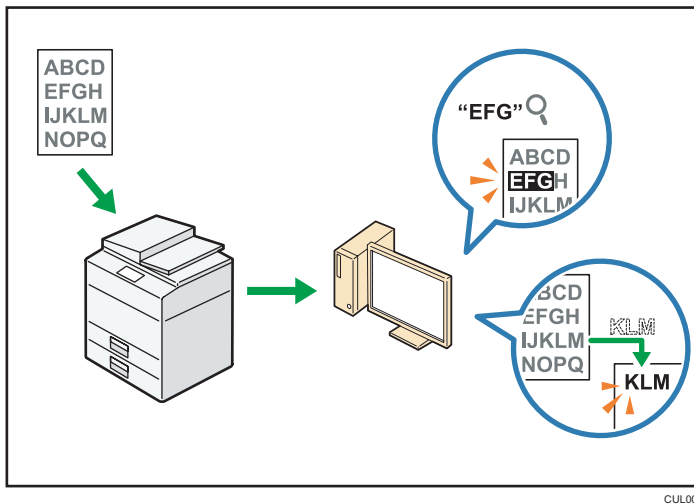

CUL003

- To use this function, the OCR unit is required.
- You can select a file type from [PDF], [High Compression PDF], or [PDF/A].
- This function can optically recognize characters in various languages and up to approximately 40,000 characters a page.

Reference

- See "Embedding Text Information in Scanned Data", Scan.

Preventing Information Leakage (Security Functions)

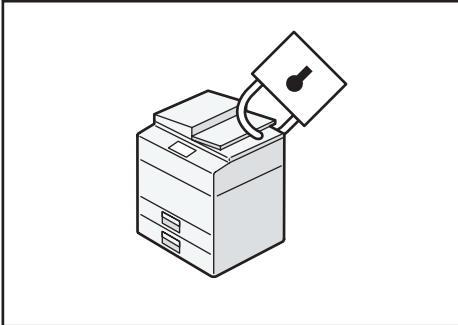

CJ0608

- You can protect documents from unauthorized access and stop them from being copied without permission.
- You can control the use of the machine, as well as prevent machine settings from being changed without authorization.
- By setting passwords, you can prevent unauthorized access via the network.
- You can erase or encrypt the data on the hard disk to minimize the risk of information leakage.
- You can limit the usage of functions for each user.

Reference

- See Security Guide.

Centrally Controlling Scan Conditions and Distribution

You can use the distributed scan management (DSM) system in Windows Server 2008 R2/2012 to manage the destinations and scan settings for each individual user in a group and to use the information when distributing scanned data.

You can also use this system to centrally manage information about people using the network and the machine's scanner functions. Both delivered files and user information can be controlled.

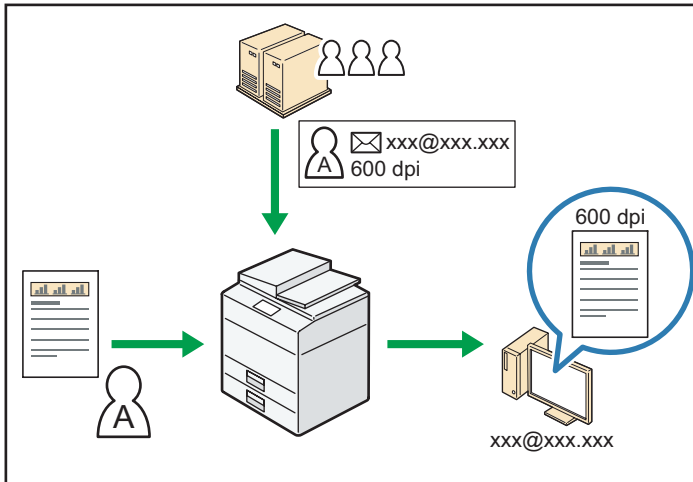

CUL004

- You must set up and configure a Windows server to use the distributed scan management system. This system is supported by Windows Server 2008 R2 or later.

Reference

- For details about how to deliver files using the distributed scan management system, see "Managing Scan Conditions and Other Settings in the Block Using Distributed Scan Management", Scan.

Monitoring and Setting the Machine Using a Computer

Using Web Image Monitor, you can check the machine's status and change the settings.

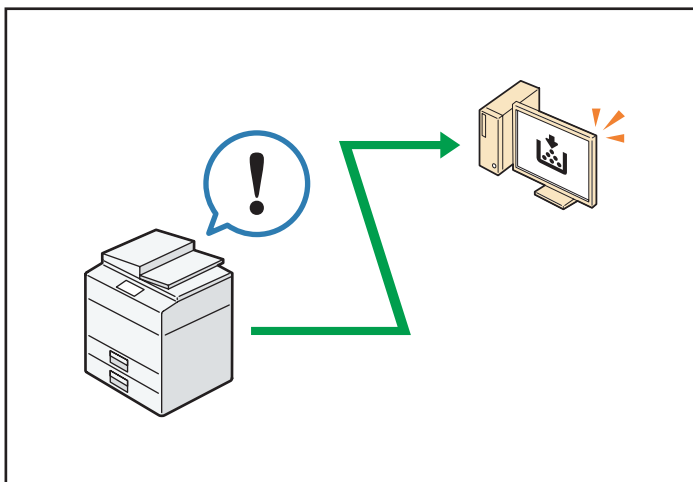

CJQ609

You can check which tray is running out of paper, register information in the Address Book, specify the network settings, configure and change the system settings, manage jobs, print the job history, and configure the authentication settings.

Reference

- See "Using Web Image Monitor", Connecting the Machine/ System Settings.
- See Web Image Monitor Help.

Preventing Unauthorized Copying

You can print embedded patterns on printouts to prevent unauthorized copying.

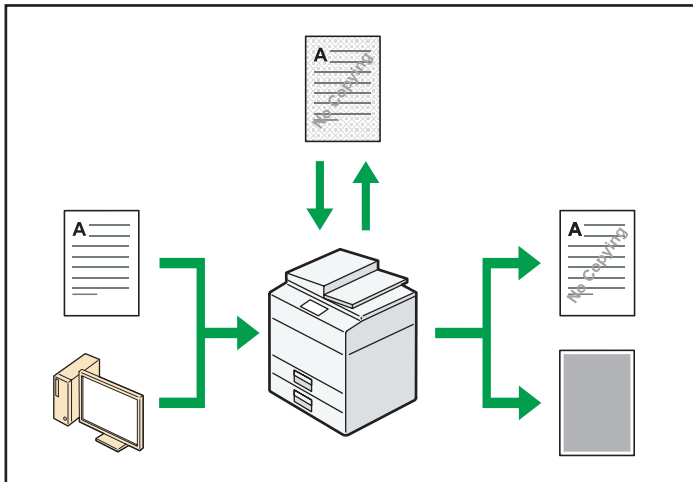

CUM003

- Using the copier function or the printer driver, you can embed a pattern in the printed document. If the document is copied on a machine with the Copy Data Security function enabled, protected pages are grayed out in the copy. This can minimize the risk of confidential information being copied. If a document protected by unauthorized copy guard is copied on a machine with the Copy Data Security function enabled, the machine beeps to notify users that unauthorized copying is being attempted.

If the document is copied on a machine with the Copy Data Security function disabled, the hidden text becomes visible in the copy, indicating that the copy is unauthorized.

- Using the copier function or the printer driver, you can embed text in the printed document for unauthorized copy prevention. If the document is copied, scanned, or stored in a Document Server by a copier or multifunction printer, the embedded text appears conspicuous in the copy, discouraging such unauthorized copying.

Reference

- For details, see Security Guide.

- For details, see the printer driver Help.
- For details about this function in the copier mode, see "Preventing Unauthorized Copies", Copy/Document Server.
- For details about this function in the printer mode, see "Printing Documents That Are Not Authorized for Duplication", Print.

Using the Application Site

For options required for this function, see "Functions Requiring Optional Configurations", Getting Started.

You can download from the Application Site useful applications that allow you to more conveniently utilize various office equipment such as copiers and printers.

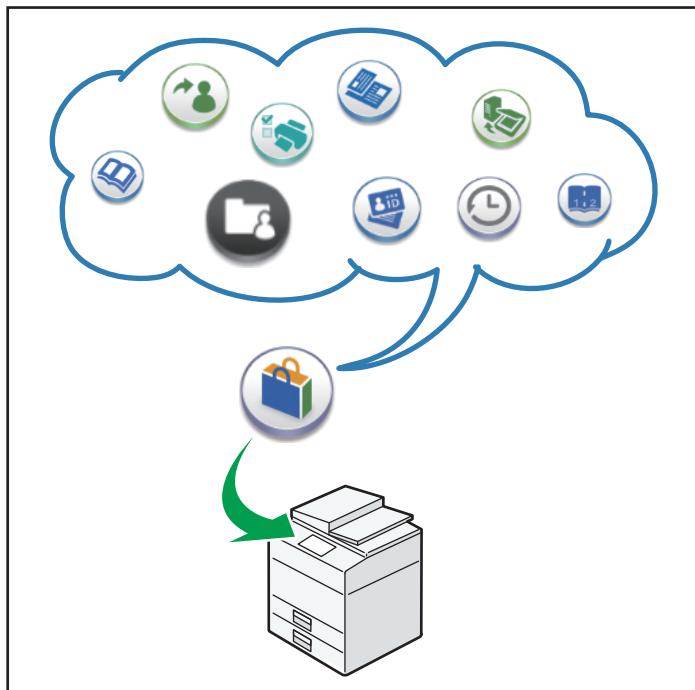

DU0010

What You Can Do on the Application Site

- Download and install applications on devices
- Update the application that has already been installed on the device
- Uninstall an application that is no longer necessary on the device

Reference

- For details, see "How to Use the Application Site", Getting Started.

2. Getting Started

This chapter describes how to start using this machine.

Guide to Names and Functions of Components

⚠ CAUTION

- Do not obstruct the machine's vents. Doing so risks fire caused by overheated internal components.

Front and left view

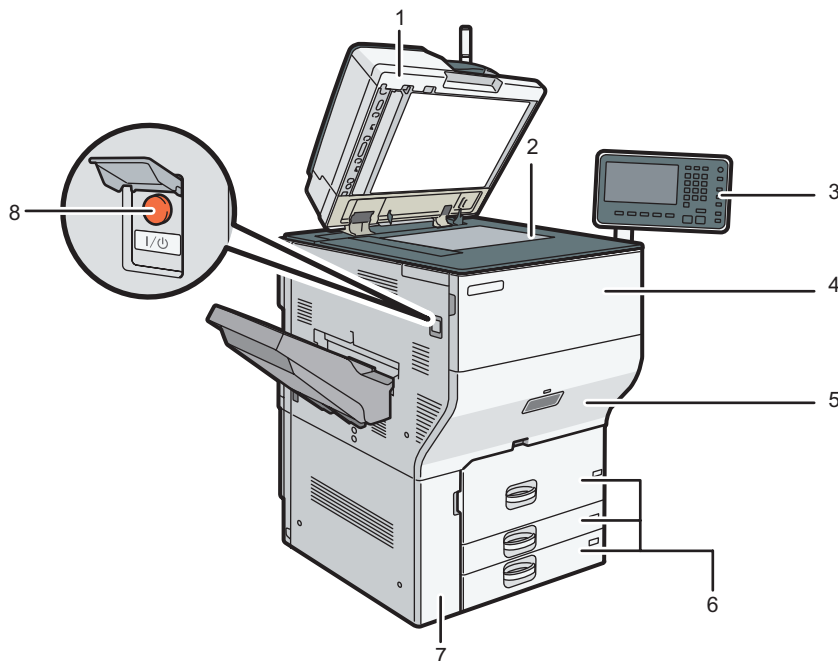

DRC106

1. ADF

Lower the ADF over originals placed on the exposure glass.

If you load a stack of originals in the ADF, the ADF will automatically feed the originals one by one.

The ADF scans both sides of an original simultaneously.

2. Exposure glass

Place originals face down here.

3. Control panel

See page 41 "Guide to the Names and Functions of the Machine's Control Panel (When Using the Standard Operation Panel)" or page 44 "Guide to the Names and Functions of the Machine's Control Panel (When Using the Smart Operation Panel)".

4. Front cover

Open to change toner cartridges.

5. Drawer

Pull out the drawer when a paper jam occurs.

6. Paper trays (Trays 1–3)

Load paper here. Tray 1 is a tandem tray where paper on the left side automatically moves to the right when paper there has run out.

7. Lower front cover

Open to change the waste toner bottle.

8. Main power switch

To operate the machine, the main power switch must be on. If it is off, open the main power switch's cover and turn the switch on.

Front and right view

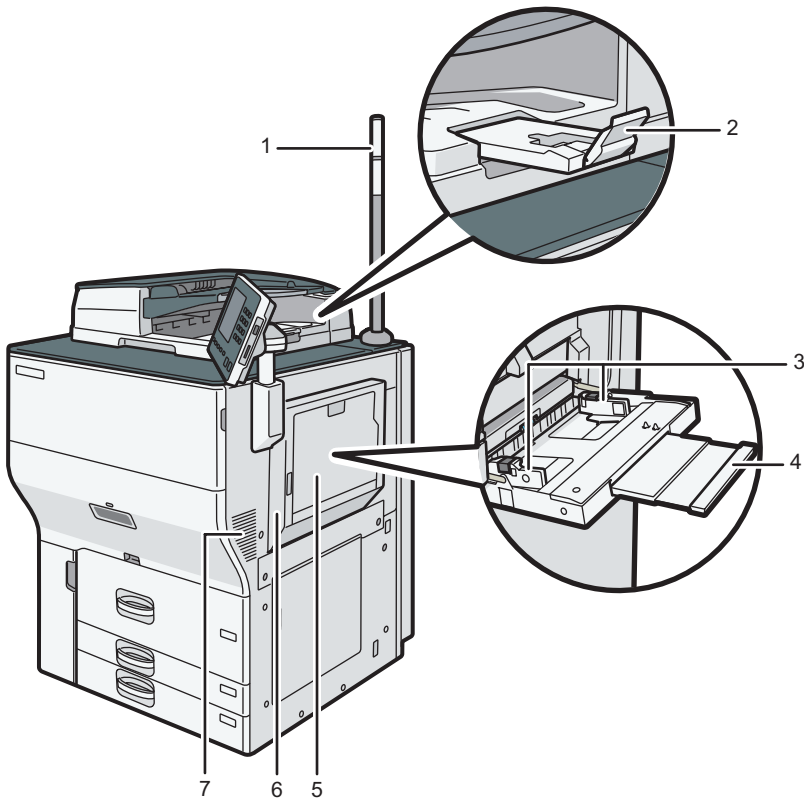

DRC107

1. Attention light

See page 28 "Guide to Functions of the Attention Light".

2. ADF's extender

Pull this extender to support large paper.

3. Paper guides

When loading paper in the bypass tray, align the paper guides flush against the paper.

4. Extender

Pull this extender out when loading sheets larger than A4, 8 1/2 x 11 in the bypass tray.

5. Bypass tray

Use to copy or print on transparencies, adhesive labels, translucent paper, and paper that cannot be loaded in the paper trays.

6. Upper right cover

Open this cover when a paper jam occurs.

7. Vents

Prevent overheating.

Rear and left view

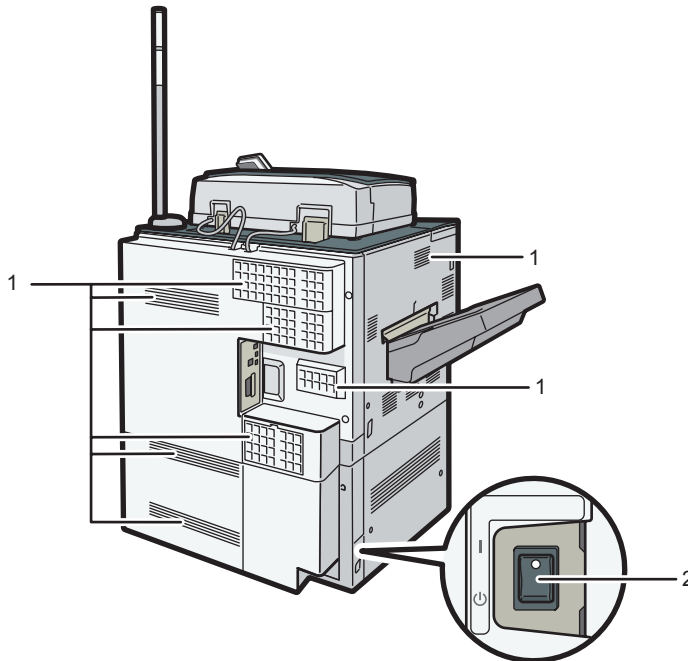

DRC108

1. Vents

Prevent overheating.

2. Anti-humidity heater switch

Prevents trays from absorbing moisture. If humidity is high and temperature is low, turn this switch on to have moisture from the paper trays absorbed and prevent the print quality from deteriorating.

Guide to Functions of the Attention Light

This section introduces functions of the attention light.

⚠ CAUTION

- Do not push or pull the attention light when installed to the machine. Doing so may result in damage or malfunction of the attention light or the machine.

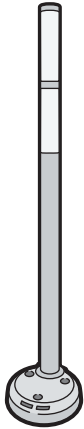

CUV121

The attention light notifies the user by light when there is a paper jam or no paper is left.

The colors of the lamp and their meanings are as follows:

Lamp	Status
The bottom lamp lights blue.	Printing
The bottom lamp flashes blue.	<ul style="list-style-type: none"> • Scanning • Data in
The top lamp lights red.	<p>Error occurred (Example)</p> <ul style="list-style-type: none"> • When the service call message appears • Paper jam • Out of paper • Out of toner • Memory overflow <p>Read the message on the display panel, and then take appropriate action. For details, see "When Messages Appear", Troubleshooting.</p>

Lamp	Status
The top lamp flashes yellow.	<p>Warning (Example)</p> <ul style="list-style-type: none">• Toner has nearly run out.• Waste toner bottle is nearly full.• Paper has nearly run out.*¹ <p>Read the message on the display panel, and then take appropriate action. For details, see "When Messages Appear", Troubleshooting.</p>

* 1 When [Low Paper Indicator (Yellow Flashing)] is set to [Active].

Guide to Functions of the Machine's Options

Guide to Functions of the Machine's External Options

2

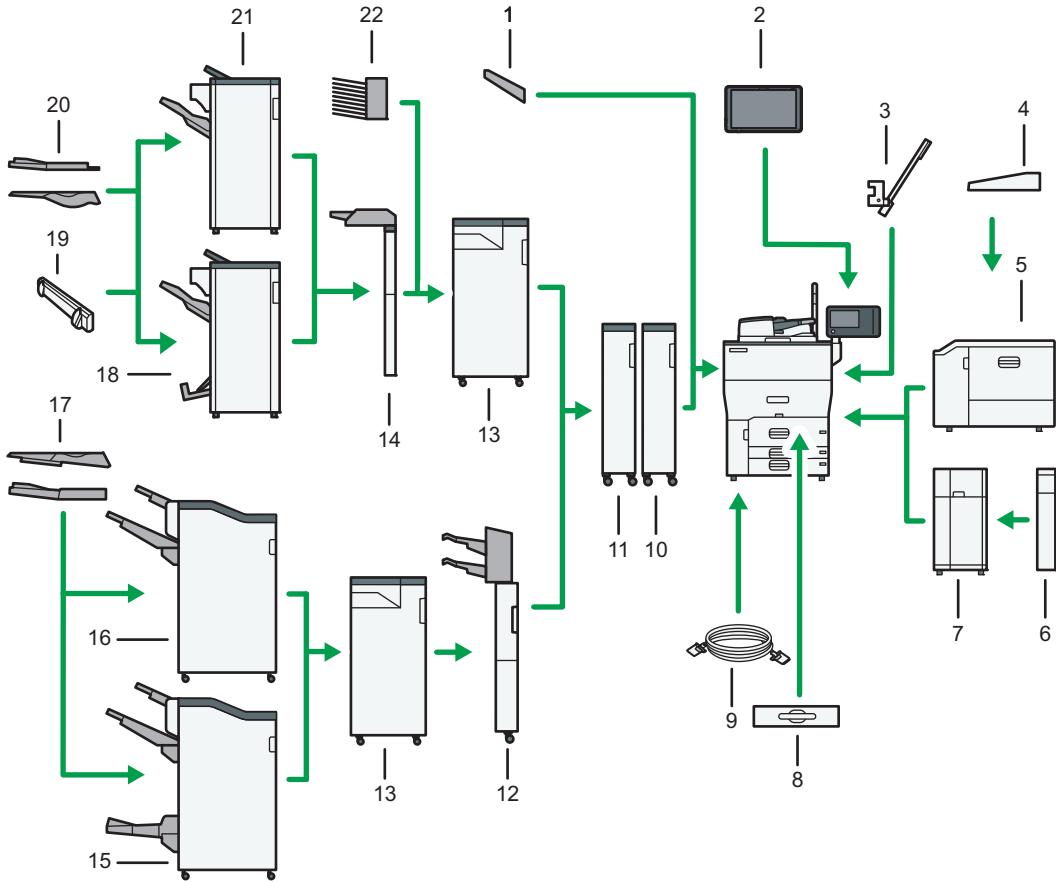

EBB005

1. Copy tray

If you select this as the output tray, copied/printed paper is delivered here face down.

2. Smart Operation Panel

This control panel is provided with advanced operativity.

3. Multi bypass banner sheet tray

Allows you to load paper that has a horizontal length of 487.8 mm (19.21 inches) or longer in the bypass tray.

4. Banner sheet guide tray

Allows you to load paper that has a horizontal length of 487.8 mm (19.21 inches) or longer in the bypass tray.

5. Wide LCT

Holds 2,200 sheets of paper. Use to copy or print onto transparencies, adhesive labels, translucent paper, and custom size paper.

6. Extension unit

Attached to the LCT and holds 2,500 sheets of B4 JIS□, A4□, 8¹/₂ × 14□, or 8¹/₂ × 11□ paper.

7. Large capacity tray (LCT)

Holds up to 4,400 sheets of paper.

8. A3/11 × 17 tray unit

You can load paper sizes up to A3□ or 11 × 17□ in Tray 1 using this unit. To use this unit on your machine, you must contact your service representative and request that they install it for you. If you install the A3/11 × 17 tray unit on your machine, you cannot use it as a tandem tray.

9. Copy connector

Allows you to use the connect copy function.

10. Decurler unit

Flattens curls from sheets to prevent paper jams.

11. Buffer pass unit

Cools copies or prints.

12. Twin interposer

Inserts cover or slip sheets into copied or printed paper.

13. Multi-folding unit

The Multi-folding unit can apply the following folds: Half Fold, Letter Fold-out, Letter Fold-in, Double Parallel Fold, Gate Fold, and Z-fold.

14. Interposer

Inserts cover or slip sheets into copied or printed paper.

15. Booklet Finisher SR5080

Sorts, stacks, and staples multiple sheets of paper. The saddle stitch function can staple multiple sheets of paper in the center and fold them into booklets. Consists of the following paper trays:

- Finisher upper tray
- Finisher shift tray
- Finisher booklet tray

Prints can be punched if the optional punch unit is installed on the finisher.

16. Finisher SR5070

Sorts, stacks, and staples multiple sheets of paper. Consists of the following paper trays:

- Finisher upper tray
- Finisher shift tray

Prints can be punched if the optional punch unit is installed on the finisher.

17. SR5000 series output tray for banner sheet

Allows you to output paper that has a horizontal length of 487.8 mm (19.21 inches) or longer on Finisher SR5070 or Booklet Finisher SR5080.

18. Booklet Finisher SR4130

Sorts, stacks, and staples multiple sheets of paper. The saddle stitch function can staple multiple sheets of paper in the center and fold them into booklets. Consists of the following paper trays:

- Finisher upper tray
- Finisher shift tray
- Finisher booklet tray

Copies can be punched if the optional punch unit is installed on the finisher.

19. Output jogger

Jogs the sheets delivered to the finisher shift tray.

20. SR4000 series output tray for banner sheet

Allows you to output paper that has a horizontal length of 487.8 mm (19.21 inches) or longer on Finisher SR4120 or Booklet Finisher SR4130.

21. Finisher SR4120

Sorts, stacks, and staples multiple sheets of paper. Consists of the following paper trays:

- Finisher upper tray
- Finisher shift tray

Copies can be punched if the optional punch unit is installed on the finisher.

22. Mailbox

Sorts printed paper. Consists of mailbox output trays 1–9.

Note

- You cannot install multiple finishers simultaneously.
- To use the twin interposer, Finisher SR5070 or Booklet Finisher SR5080 is required.
- To use the Multi-folding unit, Finisher SR4120, Booklet Finisher SR4130, Finisher SR5070, or Booklet Finisher SR5080 is required.
- To use the interposer, Finisher SR4120 or Booklet Finisher SR4130 is required.
- To use the output jogger, Finisher SR4120 or Booklet Finisher SR4130 is required.
- To use the mailbox, Finisher SR4120 or Booklet Finisher SR4130 is required.
- Remove printouts from Finisher SR4120 or Booklet Finisher SR4130 by lifting them straightforwardly from the left side. If you remove printouts at an angle or towards the front, the shift tray may rise and catch them.

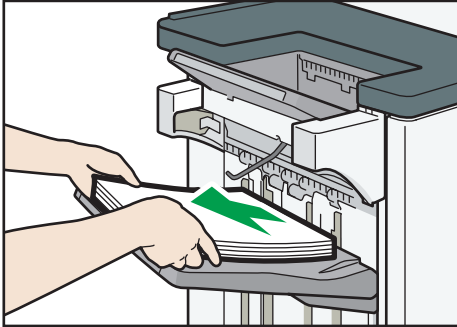

DRB977

Removing prints from Finisher SR4120 or Booklet Finisher SR4130 during printing

This section describes how to suspend a large copy or print job when using Finisher SR4120 or Booklet Finisher SR4130 with the cooling fan unit installed.

Depending on the image you are copying or printing, prints might not stack properly. If this happens, suspend the job, remove the prints and then restart the job.

1. Press the [Suspend / Resume] key near the paper outlet port.

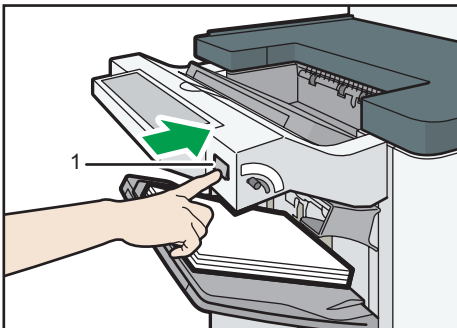

DRB266

1. [Suspend / Resume] key

2. Remove the stack of paper from the finisher shift tray.

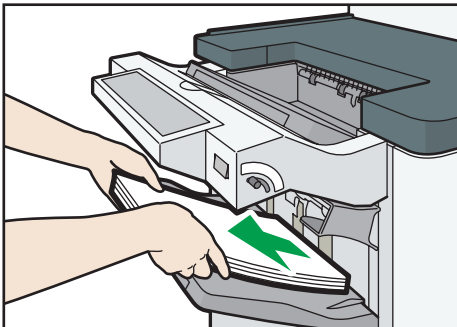

DRB287

3. Press the [Suspend / Resume] key to restart the print.

Note

- You can suspend copying or printing only when the finisher shift tray is selected as the output tray.

Removing prints from Finisher SR5070 or Booklet Finisher SR5080 during printing

This section describes how to suspend a print job when using the finisher.

Depending on the image you are printing, prints might not stack properly. If this happens, suspend the job, remove the prints and then restart the job.

1. Press the [Suspend / Resume] key.

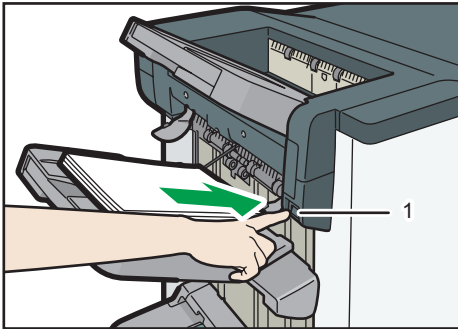

DRC113

1. [Suspend / Resume] key

2. Remove the stack of paper from the finisher shift tray.

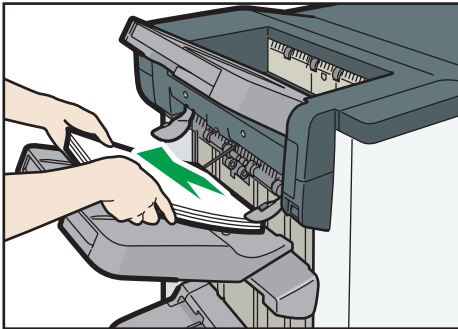

DRC114

3. Press the [Suspend / Resume] key to restart the print.

Note

- You can suspend printing only when the finisher shift tray is selected as the output tray.

When using the Z-fold function with Finisher SR4120 or Booklet Finisher SR4130 and Multi-folding unit

To use the Z-fold function, you must attach the Z-fold support tray.

Finisher SR4120 and Booklet Finisher SR4130

- Finisher upper tray

1. Remove the output paper.
2. Attach the Z-fold support tray to the finisher upper tray.

- Z-fold support tray 1

When using paper whose size is other than A5, A6, B6 JIS, or special paper, attach the Z-fold support tray 1 ^{*1}.

*1 The back of the Z-fold support tray 1 is embossed with "1".

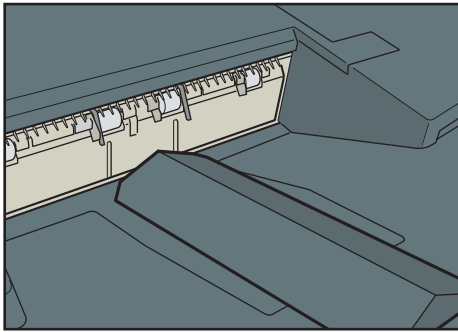

DPZ170

- Z-fold support tray 2

When the paper size is A5, A6, or B6 JIS, attach the Z-fold support tray 2 ^{*2}.

*2 The back of the Z-fold support tray 2 is embossed with "2".

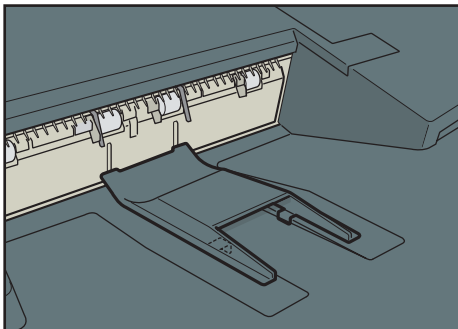

CNM016

- Finisher shift tray

1. If the finisher is installed with the cooling fan unit, press the [Suspend / Resume] key near the paper outlet port.

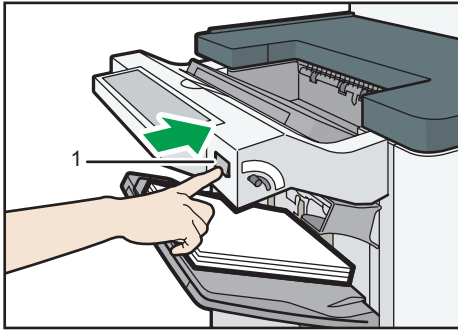

DRB286

1. [Suspend / Resume] key

If the finisher is not installed with the cooling fan unit, proceed to Step 2.

2. Remove the stack of paper from the finisher shift tray.
3. Attach the Z-fold support tray 3 *3.

*3 The back of the Z-fold support tray 3 is embossed with "3".

Z-fold support tray 3

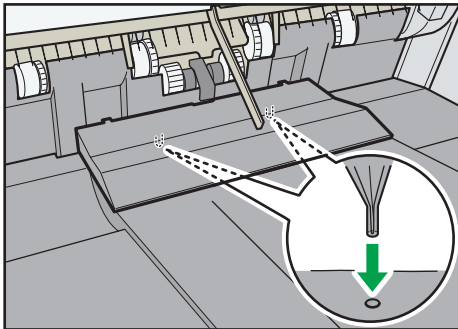

CNM015

Attach the Z-fold support tray 3 by inserting the two protrusions on its underside into the holes on the finisher shift tray.

If the finisher is installed with the cooling fan unit, proceed to Step 4.

4. Press the [Suspend / Resume] key.

Multi-folding unit

1. Open the front cover of the multi-folding unit and take out the Z-fold support tray for multi-folding unit (located at the bottom of the multi-folding unit).

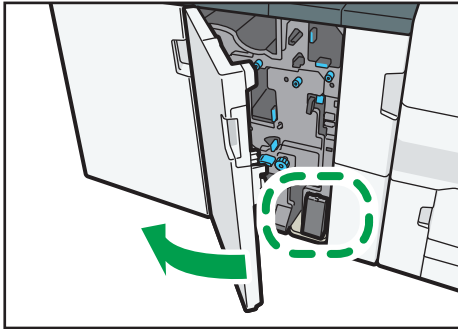

CVF025

2. Attach the Z-fold support tray for multi-folding unit in the slope of the folding unit tray so that it is flush against the end fence.

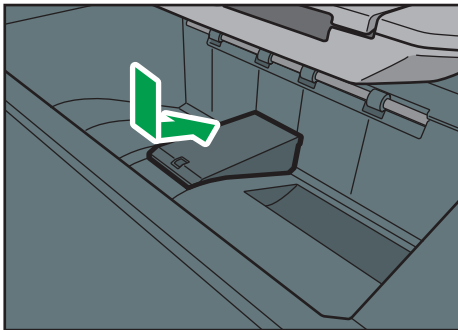

CVF026

3. Close the front cover of multi-folding unit.

When you have finished using the Z-fold support tray for multi-folding unit, open the front cover of the multi-folding unit and re-attach the tray to its stowage hook.

When using the Z-fold function with Finisher SR5070 or Booklet Finisher SR5080 and Multi-folding unit

To use the Z-fold function, you must attach the Z-fold support tray.

Finisher SR5070 and Booklet Finisher SR5080

- Finisher shift tray

Attach the Z-fold support tray*¹ by inserting the two protrusions on its underside into the holes on the finisher shift tray.

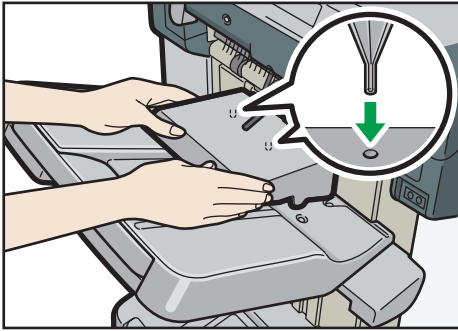

DRC115

* 1 The back of the Z-fold support tray is embossed with "5".

Multi-folding unit

1. Open the front cover of the multi-folding unit and take out the Z-fold support tray for multi-folding unit (located at the bottom of the multi-folding unit).

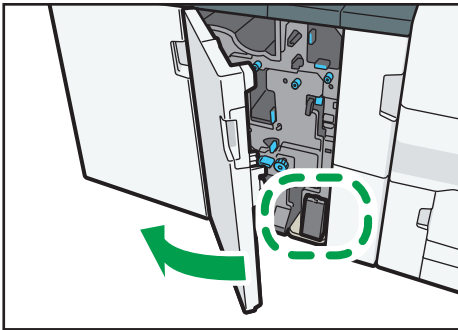

CVF025

2. Attach the Z-fold support tray in the slope of the folding unit tray so that it is flush against the end fence.

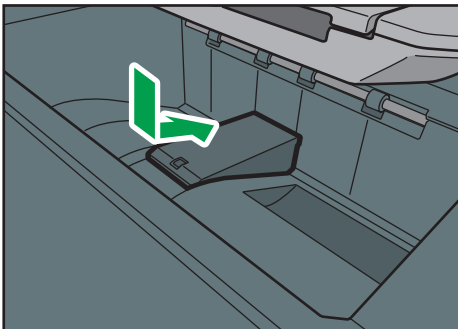

CVF026

3. Close the front cover of multi-folding unit.

When you have finished using the Z-fold support tray for multi-folding unit, open the front cover of the multi-folding unit and re-attach the tray to its stowage hook.

When printing on thin paper with Finisher SR5070 or Booklet Finisher SR5080

To print on thin plain paper that has a horizontal length of 420.1 mm (16.54 inches) or longer (A3 or larger) and weighs 64.0 g/m² (17.1 lb. Bond) or less, or to print on coated paper that has a horizontal length of 420.1 mm (16.54 inches) or longer (A3 or larger) and weighs 80.0 g/m² (21.3 lb. Bond) or less, attach the thin paper support tray ^{*1} to the finisher shift tray.

*1 The back of the thin paper support tray is embossed with "4".

1. Press the [Suspend / Resume] key.
2. Remove the stack of paper from the finisher shift tray.
3. Pull the extender of the finisher shift tray out.

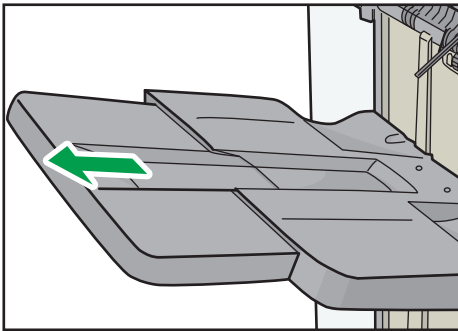

DRC121

4. Attach the thin paper support tray by setting its protrusions onto the back fence of the finisher shift tray.

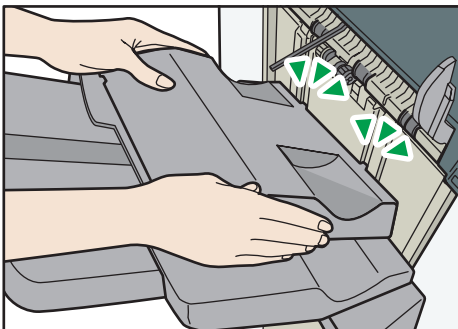

DRC122

5. Press the [Suspend / Resume] key to restart the print.

Precautions for using Finisher SR4120 or Booklet Finisher SR4130

- When moving the finisher, do not hold the guide covers. Otherwise, the covers might be damaged.

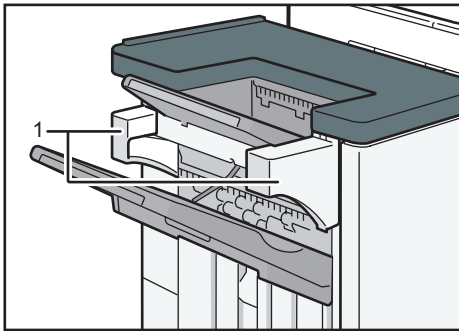

DRB285

2

1. Guide covers

- Do not hit the finisher (for instance, do not hit the surface of the finisher repeatedly to arrange stacks of paper neatly).

Guide to the Names and Functions of the Machine's Control Panel (When Using the Standard Operation Panel)

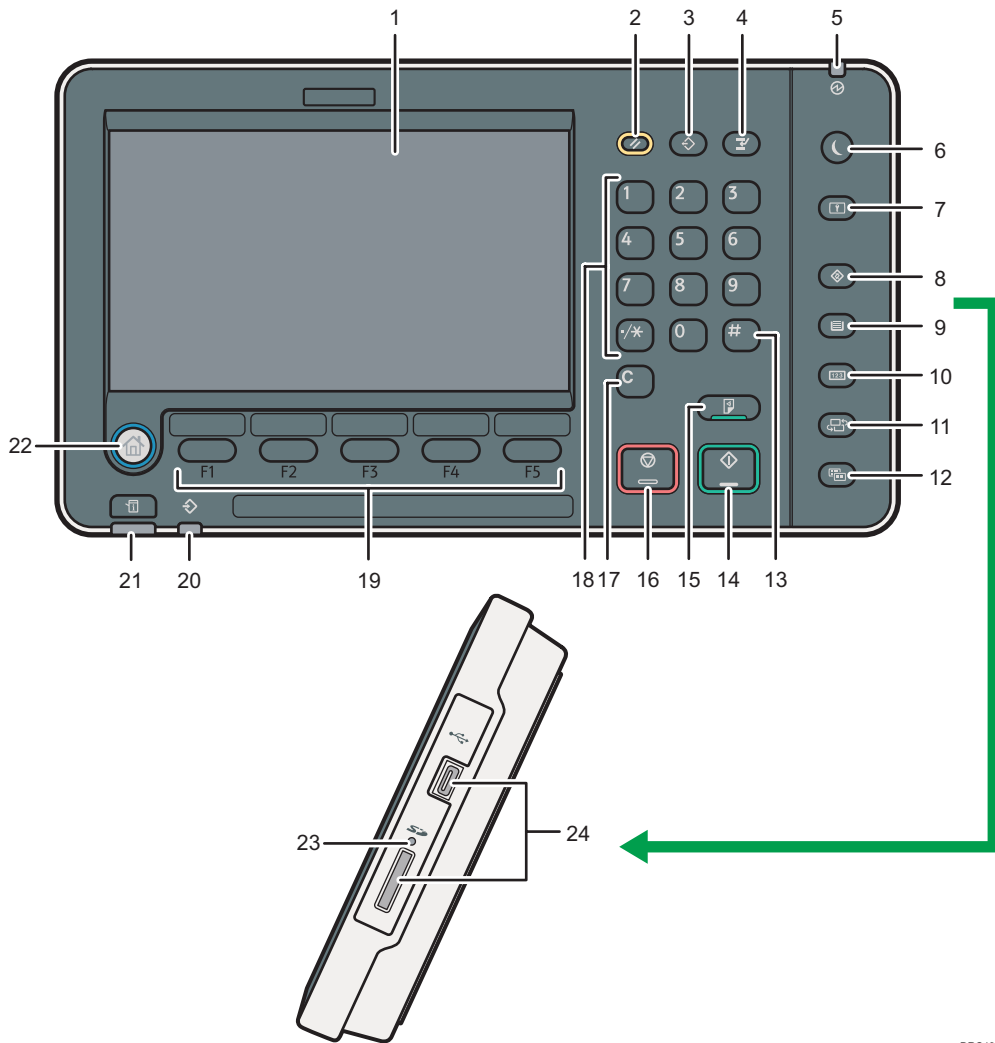

1. Display panel

Displays keys for each function, operation status, or messages. See page 47 "How to Use the [Home] Screen (When Using the Standard Operation Panel)" and page 47 "How to Use the [Home] Screen (When Using the Standard Operation Panel)".

2. [Reset] key

Press to clear the current settings.

DRC139

3. [Program] key (copier, Document Server, and scanner mode)

- Press to register frequently used settings, or to recall registered settings.
See "Registering Frequently Used Functions (When Using the Standard Operation Panel)", Convenient Functions.
- Press to program defaults for the initial display when modes are cleared or reset, or immediately after the main power switch is turned on.
See "Changing the Default Functions of the Initial Screen", Convenient Functions.

4. [Interrupt] key

Press to make interrupt copies. See "Interrupt Copy", Copy/ Document Server.

5. Main power indicator

The main power indicator goes on when you turn on the main power switch.

6. [Energy Saver] key

Press to switch to and from Low Power mode or Sleep mode. See "Saving Energy", Getting Started.

When the machine is in Low Power mode, the [Energy Saver] key is lit. In Sleep mode, the [Energy Saver] key flashes slowly.

7. [Login/Logout] key

Press to log in or log out.

8. [User Tools] key

Press to change the default settings to meet your requirements. See "Accessing User Tools", Connecting the Machine/ System Settings.

You can find out where to order expendable supplies and where to call when a malfunction occurs. You can also print these details. See "Checking Inquiry using the User Tools", Maintenance and Specifications.

9. [Paper Setting] key

Specify settings for the paper tray. See Paper Settings.

10. [Counter] key

Press to check or print the counter value. See "Counter", Maintenance and Specifications.

11. [Language] key

Press to change the language of the display. See page 45 "Changing the Display Language (When Using the Standard Operation Panel)".

12. [Simple Screen] key

Press to switch to the simple screen. See "Switching Screen Patterns (When Using the Standard Operation Panel)", Getting Started.

13. [#] key (Enter key)

Press to confirm values entered or items specified.

14. [Start] key

Press to start copying, printing, scanning, or sending.

15. [Sample Copy] key

Press to make a single set of copies or prints to check print quality before making multiple sets. See "Sample Copy", Copy/ Document Server.

16. [Stop] key

Press to stop a job in progress, such as copying, scanning or printing.

17. [Clear] key

Press to delete a number entered.

18. Number keys

Use to enter the numbers for copies and data for the selected function.

19. Function keys

No functions are registered to the function keys as a factory default. You can register often used functions and programs. For details, see "Configuring function keys (when using the standard operation panel)", Getting Started.

20. Data In indicator (printer mode)

Flashes when the machine is receiving print jobs from a computer. See Print.

21. [Check Status] key

Press to check the machine's system status, operational status of each function, and current jobs. You can also display the job history and the machine's maintenance information.

22. [Home] key

Press to display the [Home] screen. For details, see page 47 "How to Use the [Home] Screen (When Using the Standard Operation Panel)".

23. Media access lamp

Lights up when an SD card is inserted in the media slot.

24. Media slots

Use to insert an SD card or a USB flash memory device. For details, see "Inserting/Removing a Memory Storage Device", Getting Started.

Guide to the Names and Functions of the Machine's Control Panel (When Using the Smart Operation Panel)

2

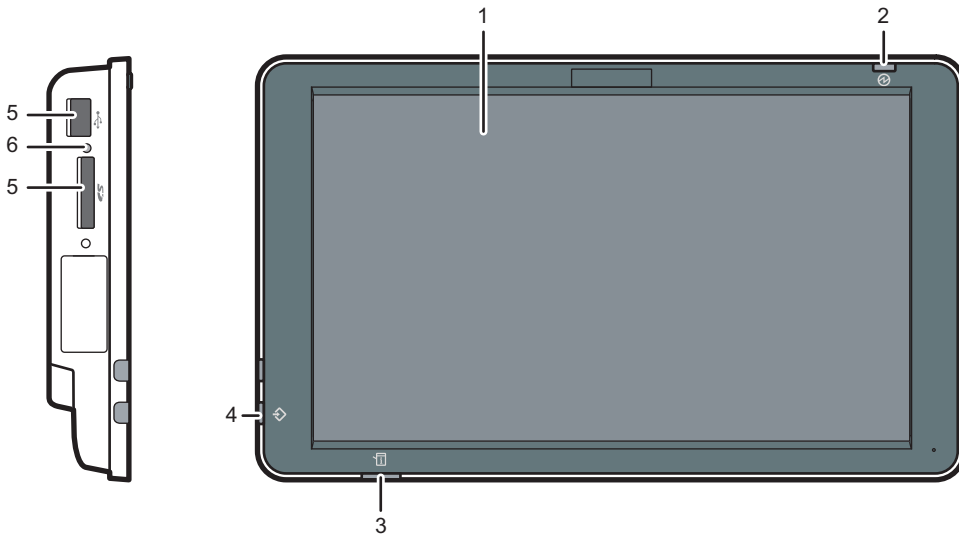

DRB135

1. Display panel

This is a touch panel display that features icons, keys, shortcuts, and widgets that allow you to navigate the screens of the various functions and applications and provide you with information about operation status and other messages. See page 56 "How to Use the [Home] Screen (When Using the Smart Operation Panel)" and page 64 "How to Use Each Application (When Using the Smart Operation Panel)".

2. Main power indicator

The main power indicator goes on when you turn on the main power switch. When the machine is in Sleep mode, the main power indicator flashes slowly. In Low Power mode or Fusing Unit Off mode, the main power indicator is lit.

3. Status indicator

Indicates the status of the system. Stays lit when an error occurs or the toner runs out.

4. Data In indicator (printer mode)

Flashes when the machine is receiving print jobs from a computer. See Print.

5. Media slots

Use to insert an SD card or a USB flash memory device. For details, see "Inserting/Removing a Memory Storage Device", Getting Started.

6. Media access lamp

Lights up when an SD card is inserted in the media slot.

Changing the Display Language (When Using the Standard Operation Panel)

You can change the language used on the display. English is set as default.

1. Press the [Language] key until the language you want to display appears.

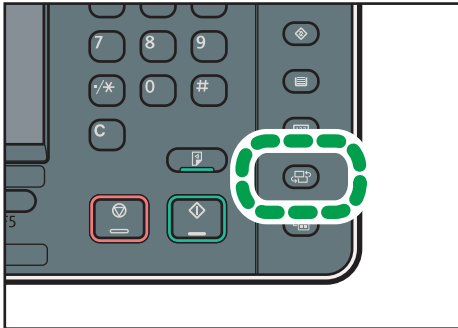

CUV112

Changing the Display Language (When Using the Smart Operation Panel)

You can change the language used on the display. English is set as default.

2

1. Press [Home]  at the bottom of the screen in the center.
2. Press the [Change Langs. Widget] icon on the [Home] screen.
3. Select the language you want to display.
4. Press [OK].

How to Use the [Home] Screen (When Using the Standard Operation Panel)

↓ Note

- You cannot switch modes in any of the following situations:
 - While scanning an original using the scanner function
 - When accessing User Tools / Inquiry
 - During interrupt copying
- The [Top] screen is set as the default screen when the machine is turned on. You can change this default setting under Function Priority. See "System Settings", Connecting the Machine/ System Settings.

2

Displaying the [Home] Screen (When Using the Standard Operation Panel)

1. Press the [Home] key on the control panel.

If the [Home] screen does not appear, press the  icon at the upper right corner of the screen to switch to the menu screen.

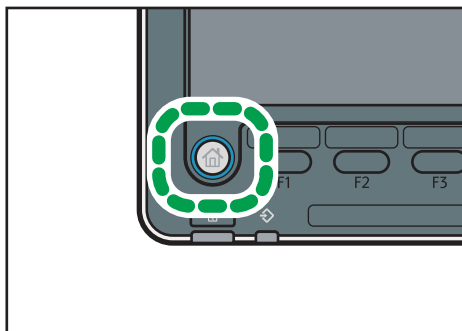

CUV108

↓ Note

- Function or shortcut icons will be displayed on the [Home] screen. For details, see page 48 "How to Use the [Top] Screen and the [Home] Screen (When Using the Standard Operation Panel)".
- To use a different function, press the icon of the function you want to use. For details, see "Changing Modes by Pressing the Function Keys (When Using the Standard Operation Panel)", Getting Started.

How to Use the [Top] Screen and the [Home] Screen (When Using the Standard Operation Panel)

When you press the [Home] key just after the machine is turned on, the [Top] screen is displayed.

Using the [Top] screen, you can check the toner status and paper status.

The icons of each function are displayed on the [Home] screen.

You can add shortcuts to frequently used programs to the [Home] screen. The program shortcuts appear on the [Home] screen. The programs can be recalled easily by pressing the shortcuts.

To display the [Home] screen, press the [Home] key. If the [Home] screen does not appear, press the  icon at the upper right corner of the screen to switch to the menu screen.

[Top] screen

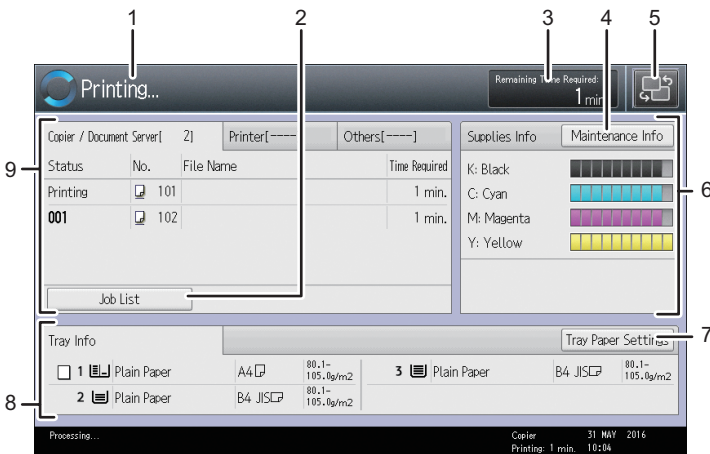

DRC146

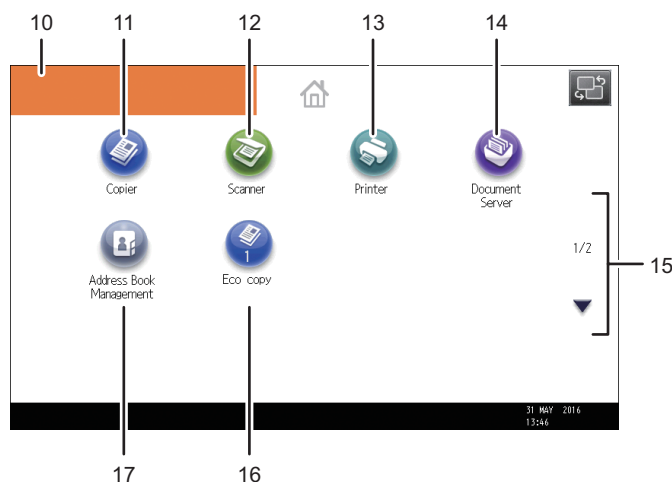
[Home] screen

DRC147

1. Operational status and messages

Displays operational status and messages.

2. [Job List]

Press to display the [Current Job] tab on the [Check Status] screen.

3. Estimated time

Indicated by the time estimated to complete the job at the top of the currently displayed job list.

4. [Maintenance Info]

Press to display the [Maintnc./Inquiry/Mach. Info] tab on the [Check Status] screen.

5. Switch screens

Press to switch between the [Home] screen and the [Top] screen.

6. [Supplies Info]

Displays the information about supplies, such as the remaining amount of toner.

7. [Tray Paper Settings]

Press to display the [Tray Paper Settings] screen.

8. [Tray Info]/[Interposer Info]

Displays the status of the paper trays and the interposer.

9. [Job List]

Displays current and pending jobs.

10. Home screen image

You can display an image on the [Home] screen, such as a corporate logo. To change the image, see "Displaying the Image on the [Home] Screen (When Using the Standard Operation Panel)", Convenient Functions.

11. [Copier] 

Press to make copies.

For details about how to use the copy function, see Copy/ Document Server.

12. [Scanner] 

Press to scan originals and save images as files.

For details about how to use the scanner function, see Scan.

13. [Printer] 

Press to make settings for using the machine as a printer.

For details about how to make settings for the printer function, see Print.

14. [Document Server] 

Press to store or print documents on the machine's hard disk.

For details about how to use the Document Server function, see Copy/ Document Server.

15. ▲/▼

Press to switch pages when the icons are not displayed on 1 page.

16. Shortcut icon

You can add shortcuts to programs to the [Home] screen. For details about how to register shortcuts, see page 50 "Adding Icons to the [Home] Screen (When Using the Standard Operation Panel)". The program number appears on the bottom of the shortcut icon. For details about examples of shortcuts that you can program, see "Example of programs (when using the standard operation panel)", Convenient Functions.

17. [Address Book Management] 

Press to display the Address Book.

For details about how to use the Address Book, see "Address Book", Connecting the Machine/ System Settings.

Note

- When an embedded software application is installed, a function icon for the application is displayed on the [Home] screen.
- You can change the order of icons. For details, see "Changing the Order of Icons on the [Home] Screen (When Using the Standard Operation Panel)", Convenient Functions.
- On the simple screen, up to 8 icons are displayed on each page. Letters and keys are displayed in a larger size, making operations easier. On the standard screen, up to 12 icons are displayed on each page. For details, see "Switching Screen Patterns (When Using the Standard Operation Panel)", Getting Started.

Adding Icons to the [Home] Screen (When Using the Standard Operation Panel)

You can add shortcuts to programs stored in copier or scanner mode.

You can also review icons of functions and embedded software applications that you deleted from the [Home] screen.

↓ Note

- Shortcuts to programs stored in Document Server mode cannot be registered to the [Home] screen.
- Shortcut names of up to 32 characters can be displayed in a standard screen. If the name of the shortcut is longer than 32 characters, the 32nd character is replaced with "...". Only 30 characters can be displayed in a simple screen. If the name of the shortcut is longer than 30 characters, the 30th character is replaced with "...".
- For details about how to make a program, see page 73 "Registering Functions in a Program (When Using the Standard Operation Panel)".
- For details about the procedure for registering a shortcut using the [Program] screen, see page 51 "Registering a shortcut to a program to the [Home] screen (when using the standard operation panel)".
- You can register up to 72 function and shortcut icons. Delete unused icons if the limit is reached. For details, see "Deleting an Icon on the [Home] Screen (When Using the Standard Operation Panel)", Convenient Functions.
- You can change the position of icons. For details, see "Changing the Order of Icons on the [Home] Screen (When Using the Standard Operation Panel)", Convenient Functions.

Registering a shortcut to a program to the [Home] screen (when using the standard operation panel)

You can register shortcuts to programs stored in copier or scanner mode to the [Home] screen. Once you have registered a shortcut, you can recall the program with just one touch.

1. Display the [Copier] or [Scanner] screen.
2. Press the [Program] key.

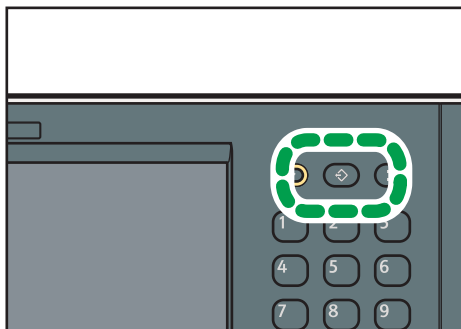

CUP001

3. Press [Program to Home].
4. Select the number of the program you want to register as a shortcut.

5. Press [Yes].

6. Press [Exit].

Note

-  next to a program means that its shortcut is registered in the [Home] screen.
- New shortcut icons are added next to the last position of a shortcut icon in line. If an icon already exists in the last position, the new icon is placed in the first available position from the front of the line.
- For details about registering a shortcut on the [Home] Screen when using the Smart Operation Panel, see page 61 "Adding Icons to the [Home] Screen (When Using the Smart Operation Panel)".

Adding icons to the [Home] screen using Web Image Monitor (when using the standard operation panel)

1. Start Web Image Monitor.

For details, see "Using Web Image Monitor", Connecting the Machine/ System Settings.

2. Log in to Web Image Monitor.

3. To add icons to the default [Home] screen, point to [Device Management], and then click [Device Home Management].

Proceed to Step 5.

4. To add icons to a user's [Home] screen, point to [Customize Screen per User].

5. Click [Edit Icons].

6. Point to [+Icon can be added.] of the position that you want to add, and then click [+ Add].

7. Select the function or shortcut icon you want to add.

8. Click [OK] four times.

Adding icons to the [Home] screen using the User Tools (when using the standard operation panel)

In the following procedure, a shortcut to a copier program is registered to the [Home] screen.

1. Press the [User Tools] key.

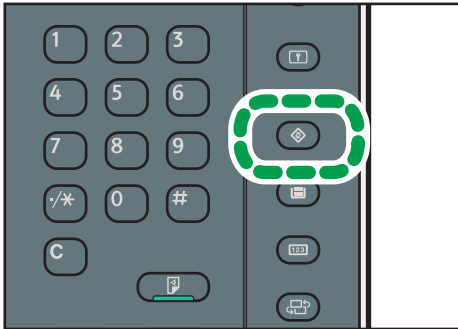

CUV110

2. Press [Edit Home].

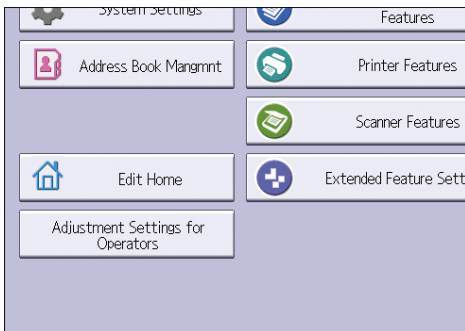

3. Press [Add Icon].

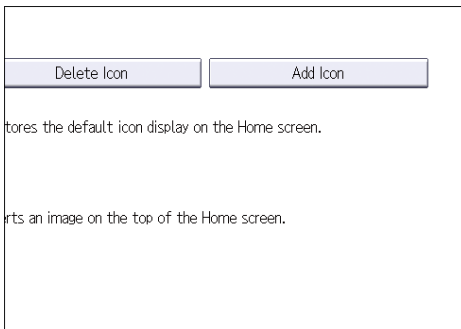

4. Press the [Program] tab.

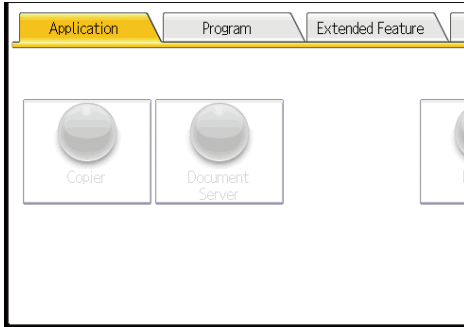

5. Make sure that [Copier Program] is selected.

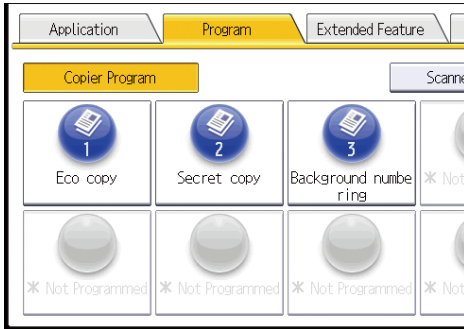

6. Select the program you want to add.

7. Specify the position where [Blank] is displayed.

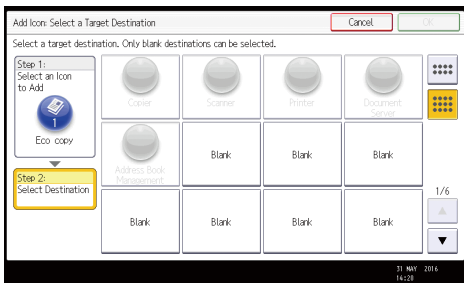

8. Press [OK].

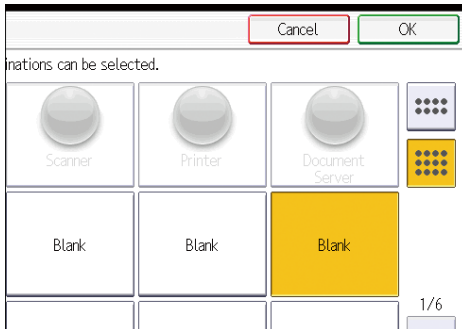

9. Press the [User Tools] key.

Note

- Press  on the upper-right corner of the screen to check the position on the simple screen.

How to Use the [Home] Screen (When Using the Smart Operation Panel)

The [Home] screen is set as the default screen when the machine is turned on.

One icon is assigned to each function, and these icons are displayed on the [Home] screen. You can add shortcuts to frequently used functions or Web pages to the [Home] screen. Also, you can register widgets such as the Change Langs. Widget to it. The [Home] screen and the screen of each function may differ depending on the optional units that are installed.

To display the [Home] screen, press [Home] (🏠) at the bottom of the screen in the center.

★ Important

- Do not apply strong impact or force to the screen, or it may be damaged. Maximum force allowable is approx. 30N (approx. 3 kgf). (N = Newton, kgf = Kilogram force. 1 kgf = 9.8N.)

To switch between screens, flick your finger to the right or left on the screen.

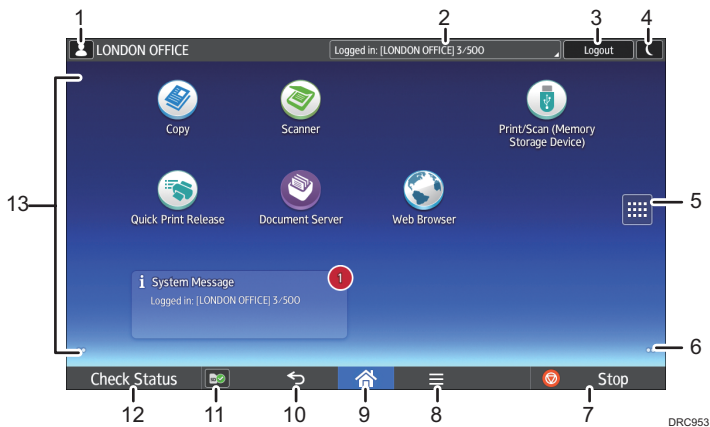

1. Logged-in user icon

When user authentication is enabled, an icon is displayed that indicates that users are logged in.

Press the icon to show the names of the users that are currently logged in.

2. System message

Displays messages from the machine system and applications.

3. [Login]/[Logout]

These keys are displayed when user authentication is enabled. When you press [Login], the authentication screen appears. If you have been already logged in to the machine, [Logout] appears. To log out of the machine, press [Logout].

For details about how to log in and out, see page 87 "Logging In the Machine".

4. [Energy Saver] 🌙

Press to switch to Low Power mode or Sleep mode.

For details about the modes, see "Saving Energy", Getting Started.

5. Application list icon

Press to display the application list. You can create shortcuts to the applications on the [Home] screen.

To use an application displayed in the [Widgets] tab and [Program] tab, create a shortcut for the application on the [Home] screen. For details, see "Customizing the [Home] Screen (When Using the Smart Operation Panel)", Convenient Functions.

6. Icons to switch between screens

Press to switch between the five home screens. The icons appear at the bottom right and left of the screen, the number of icons indicates the number of screens on each side of the current screen.

7. [Stop]

Press to stop a job in progress, such as copying, scanning, or printing.

8. [Menu]

Displays the menu screen of the application you are using. Depending on the application you are using, this key may be disabled. You can also press this key in the [Home] screen to restore the [Home] screen's settings to their defaults.

9. [Home]

Press to display the [Home] screen.

10. [Return]

Press this key to return to the previous screen while Screen Features are enabled or applications are used. Depending on the application you are using, this key may be disabled. You can specify whether this key is enabled or not in some applications. For details about the settings, see "Screen Features", Connecting the Machine/ System Settings.

11. [Media Information]

Press to remove the inserted SD card or USB flash memory device from the media slot. For details, see "Removing an SD Card" or "Removing a USB Flash Memory Device", Getting Started.

12. [Check Status]

Press to check the machine's system status, operational status of each function, and current jobs. You can also display the job history and the machine's maintenance information.

13. Icon display area

Displays the function or application icons and widgets. Displayed icons differ between the five home screens. For details about icons on each screen, see page 58 "Main Icons on the [Home] Screen (When Using the Smart Operation Panel)".

You can also add shortcuts and arrange icons using folders. For details, see "Customizing the [Home] Screen (When Using the Smart Operation Panel)", Convenient Functions.





Note











- You can change the [Home] screen's wallpaper. For details, see "Changing the [Home] Screen's Wallpaper (When Using the Smart Operation Panel)", Convenient Functions.
- You can switch modes by pressing icons on the [Home] screen. You can also switch modes by pressing the function keys. For details about the function keys, see "Changing Modes by Pressing the Function Keys (When Using the Smart Operation Panel)", Getting Started.

- You cannot switch modes in any of the following situations:
 - While scanning an original using the scanner function
 - When accessing the following screens:
 - Machine Features
 - Counter
 - Inquiry
 - Address Book Management
 - Tray Paper Settings
 - Current Job / Job History
 - During interrupt copying
- The [Home] screen is set as the default screen when the machine is turned on. You can change this default setting under Function Priority. See "Screen Features", Connecting the Machine/ System Settings.

Main Icons on the [Home] Screen (When Using the Smart Operation Panel)

The following icons are displayed on the [Home] screen as a factory default:

Icon	Description
Copy 	Press to display the copier function's screen. For details about how to use the copier function, see Copy/ Document Server.
Scanner 	Press to display the scanner function's screen. For details about how to use the scanner function, see Scan.
Quick Copy 	Allows you to make settings simply by following the order of the keys left to right so you can make copies easily. You can also use the major copy functions such as duplex and combined copying. For details about how to use this function, see "[Quick Copy] Screen (When Using the Smart Operation Panel)", Getting Started.
Quick Scanner 	Allows you to select a destination from the list and send scanned data. You can send data by e-mail or to a folder. For details about how to use this function, see "[Quick Scanner] Screen (When Using the Smart Operation Panel)", Getting Started.
Printer 	Allows you to make settings for using the machine as a printer easily. See Print for details.

Icon	Description
Print/Scan (Memory Storage Device) 	Allows you to print scan files from and save them to a memory storage device. See Print for details.
Quick Print Release 	Allows you to print files easily. See Print for details.
Document Server 	Press to store or print documents on the machine's hard disk. For details about how to use the Document Server function, see Copy/Document Server.
Web Browser 	Press to display Web pages. For details, see "Using the Browser Function", Convenient Functions.
User Guide 	Press to display the manuals for the machine.
Address Book Management 	Press to display the Address Book. For details about how to use the Address Book, see "Address Book", Connecting the Machine/ System Settings.
Application Site 	Press to display the Application Site. Allows you to download applications on your machine. For details, see "How to Use Application Site", Getting Started.
User Tools 	Press to display the screen for the machine's initial settings.
System Mes. Widget 	Displays messages from the machine system and applications.
Change Langs. Widget 	Allows you to change the on-screen language.
Supply Info Widget 	Displays the remaining amount of toner.
Embedded software applications	When an embedded software application is installed, a function icon for the application is displayed on the [Home] screen.

You can add icons to the [Home] screen to customize the machine. For details about adding icons to the [Home] screen, see page 61 "Adding Icons to the [Home] Screen (When Using the Smart Operation Panel)".

Possible Operations on the Screen (When Using the Smart Operation Panel)

- Pinch-in

Place your thumb and forefinger on the screen, and then pinch the fingers together to zoom out the screen. Double-tapping can also be effective for this operation.

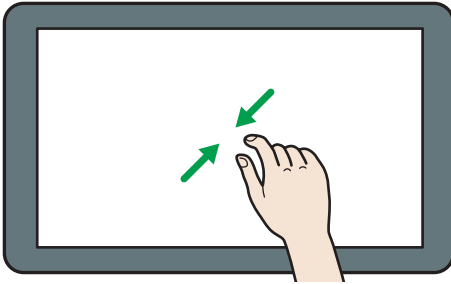

DNE103

- Pinch-out

Place your thumb and forefinger on the screen, and then spread the fingers apart to zoom in the screen. Double-tapping can also be effective for this operation.

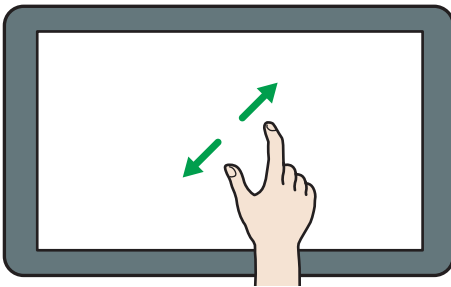

DNE104

- Flick

Flick your finger to the right or left on the screen to switch between screens.

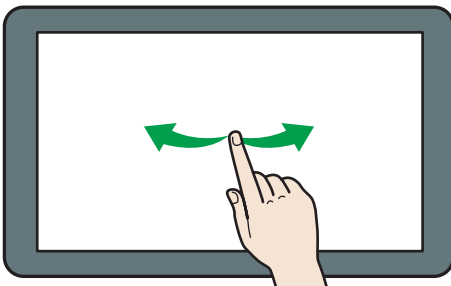

DNE102

- Long tap

Place your finger on the screen and hold it there until the next screen appears. You can display the menu screen of the application you are using.

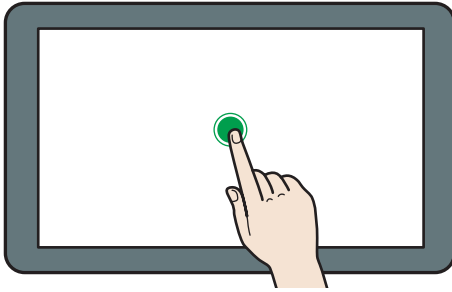

- Drag

Slide your finger while pressing the screen. You can move an icon to where you want to place it on the screen.

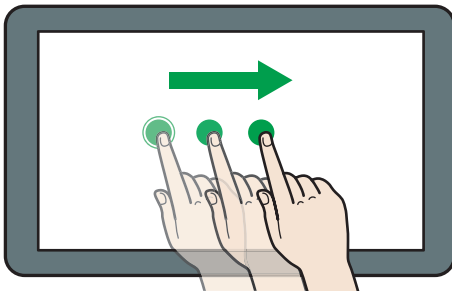



Adding Icons to the [Home] Screen (When Using the Smart Operation Panel)

Adding shortcuts to the [Home] screen (when using the Smart Operation Panel)

You can add shortcuts to the machine's functions.

You can display the icons for the machine's functions and the embedded software applications after you delete them from the [Home] screen.

1. Press [Home]  at the bottom of the screen in the center.
2. Press .
3. Press the [Apps] tab to add a shortcut to an application other than the Classic Applications. Press the [Program] tab to add a shortcut to one of the Classic Applications.
4. Select the application to which to add a shortcut.
 - Other than Classic Applications:
Press and hold down the application icon.
 - Classic Applications:
Press and hold down the [Classic Applications] icon.

The image of where the shortcut is to be placed on the [Home] screen is displayed.



5. Drag the icon to where you want to place it on the screen.

If you want to add a shortcut to the Classic Applications, proceed to Step 6.

6. Select the Classic Applications that you want to add from the list.

Adding shortcuts to bookmarks on the [Home] screen (when using the Smart Operation Panel)

You can add shortcuts to bookmarks that have been registered in favorites in the Web Browser to the [Home] screen.



1. Press [Home]  at the bottom of the screen in the center.
2. Press .
3. Press the [Program] tab.
4. Press and hold down the [Bookmark] icon.

The image of where the shortcut is to be placed on the [Home] screen is displayed.

5. Drag the icon to where you want to place it on the screen.
6. Select the bookmark you want to add from the bookmark list.

Adding shortcuts to programs to the [Home] screen (when using the Smart Operation Panel)

You can add shortcuts to programs registered on Copier, Scanner, or quick applications.

1. Press [Home]  at the bottom of the screen in the center.
2. Press .
3. Press the [Program] tab.
4. Select the program to add a shortcut.



- Other than Classic Applications:
Press and hold down the application icon.
- Classic Applications:
Press and hold down the [Classic Applications] icon.

The image of where the shortcut is to be placed on the [Home] screen is displayed.

5. Drag the icon to where you want to place it on the screen.
6. Select the program you want to add from the list.

Adding widgets to the [Home] screen (when using the Smart Operation Panel)

You can add widgets to the [Home] screen to show the remaining amount of toner or change the display language.

1. Press [Home]  at the bottom of the screen in the center.
2. Press .
3. Press the [Widget] tab.
4. Press and hold down the widget icon you want to add.

The image of where the widget is to be placed on the [Home] screen is displayed.



5. Drag the icon to where you want to place it on the screen.

How to Use Each Application

How to Use Each Application (When Using the Standard Operation Panel)

The display panel shows the operation status, messages, and function menus.

The function items displayed serve as selector keys. You can select or specify an item by lightly pressing them.

When you select or specify an item on the display panel, it is highlighted like . Keys appearing as  cannot be used.

★ Important

- **Do not apply strong impact or force to the screen, or it may be damaged. Maximum force allowable is approx. 30N (approx. 3 kgf). (N = Newton, kgf = Kilogram force. 1 kgf = 9.8N.)**

The [Top] screen is set as the default screen when the machine is turned on.

The [Home] screen and the screen of each function may differ depending on the optional units that are installed.

How to Use Each Application (When Using the Smart Operation Panel)

You can open the function screens by pressing icons such as [Copy] or [Scanner] on the [Home] screen.

Three kinds of screens ("Standard Application Screen", "Classic Application Screen", and "Quick Application Screen") can be used by each function.

Standard Application Screen

Functions and settings that are used frequently are shown on the top screen. Flick the screen up or down to select a setting item. When you select an item, the pull-down menu appears, or the setting item pops up. For details about operations on this screen, see page 59 "Possible Operations on the Screen (When Using the Smart Operation Panel)". For details about how to use the screen, see "Standard Application Screen (When Using the Smart Operation Panel)", Getting Started.

Classic Application Screen

You can select advanced functions and detailed settings according to the functions and settings you use frequently. For details about how to use this screen, see "Classic Application Screen (When Using the Smart Operation Panel)", Getting Started. For details about keys that appear on the screen of each Classic Application, see "Keys that Appear on the Initial Settings Screen and Screens of Each Classic Application (When Using the Smart Operation Panel)", Getting Started.

Quick Application Screen

You can easily set the basic operations such as duplex copying, sending scanned documents by e-mail or other operations. For details about how to use this screen, see "Quick Application Screen (When Using the Smart Operation Panel)", Getting Started.

Functions usable on each screen

Screen	Functions usable
Standard Application Screen	<ul style="list-style-type: none"> • Copier • Scanner
Classic Application Screen	<ul style="list-style-type: none"> • Copier • Scanner • Printer • Document Server
Quick Application Screen	<ul style="list-style-type: none"> • Copier • Scanner

Note



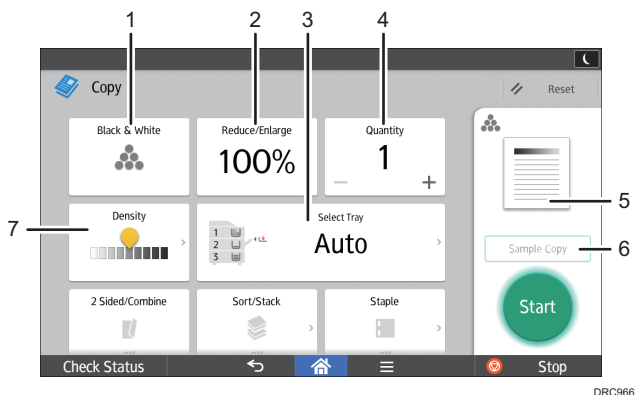

- [Copier (Classic)] icon, [Scanner (Classic)] icon, and [Printer (Classic)] icon are displayed in the Application list. For details about how to register them to the [Home] screen, see page 61 "Adding Icons to the [Home] Screen (When Using the Smart Operation Panel)".

[Copy] Screen (When Using the Smart Operation Panel)

You can switch the two screens described in this section by flicking the screen up or down.







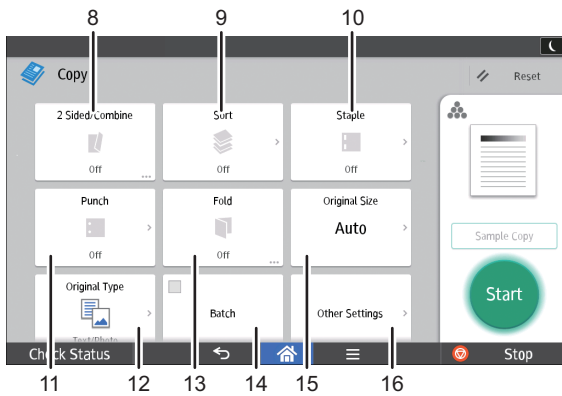

No.	Icon	Description
1		You can select a color mode.
2	100%	You can reduce or enlarge images.

No.	Icon	Description
3	Auto	You can specify the paper tray containing the paper you want to copy to.
4	1	You can specify the numbers of copies to be made. Press a number to enter the number of copies using the keyboard. You can also specify the number of copies by pressing [+] or [-].
5		Preview prints change according to the settings you make.
6		You can check the copy settings before making a long copy run.
7		You can adjust the density of the overall original in nine steps. Specify the density by touching the  icon and dragging it right or left.





DRC150





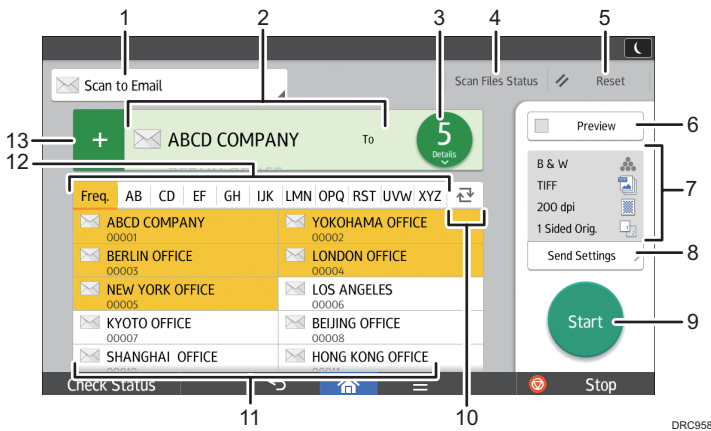

No.	Icon	Description
8		You can combine two 1-sided originals or one 2-sided original to one side of a sheet. The machine selects a reproduction ratio automatically and copies the originals onto a single sheet of copy paper.
9		You can sort copies as a set in sequential order and stack copies of each page in a multi-page original.
10		You can staple each set of copies together.
11		You can make punch holes in copies.





No.	Icon	Description
12		You can select an original type that is suitable for your originals.
13		Copies can be folded in various ways.
14	Batch	You can divide an original that has many pages and scan it in smaller batches while copying it as a single document. To do this, place several pages of the original in the ADF.
15	Auto	You can specify the size of the original when copying custom size originals.
16	Other Settings	You can find other settings.

[Scanner] Screen (When Using the Smart Operation Panel)



No.	Icon	Description
1		Displays the type of scanner destination. Press to switch between e-mail destinations and folder destinations.

No.	Icon	Description
2		<p>The specified destination is shown here.</p> <p>By tapping the destination, you can register it to the Address Book or remove it from the destinations.</p> <p>By flicking up and down, you can confirm the selected destinations.</p>
3		<p>The total number of the selected destinations appears.</p> <p>Press to display a screen to confirm destinations.</p> <p>In the screen to confirm destinations, you can do the following:</p> <ul style="list-style-type: none"> • Switch the "To", "Cc", and "Bcc" fields of the e-mail destinations • Register destinations to the Address Book • Edit destinations • Remove destinations from the destination list
4		<p>Press to display the transmission results screen.</p> <p>In the transmission results screen, you can do the following:</p> <ul style="list-style-type: none"> • Check sent jobs • Check error descriptions • Cancel transmission of a document in standby • Print a list of transmission results
5		<p>Press to clear your current settings.</p>
6		<p>Press to display the preview screen after scanning originals.</p>
7		<p>You can check the settings in Send Settings.</p>
8		<p>Press to open the send settings screen. For details, see page 69 "[Send Settings] screen (when using the Smart Operation Panel)".</p>

No.	Icon	Description
9		Press to scan originals and start sending.
10		Press to switch the section of the Address Book.
11		Shows the destinations in the Address Book. If a password or protection code is specified to a folder destination, enter the password or protection code on the screen displayed after tapping the folder destination.
12		The sections of the Address Book.
13		Press to add a destination. Destinations can be added as follows: <ul style="list-style-type: none"> • Input destinations manually • Select from the transmission history • Specify a registration number from the Address Book • Search for a destination in the Address Book or on the LDAP server

[Send Settings] screen (when using the Smart Operation Panel)

You can switch the four screens described in this section by flicking the screen up or down.

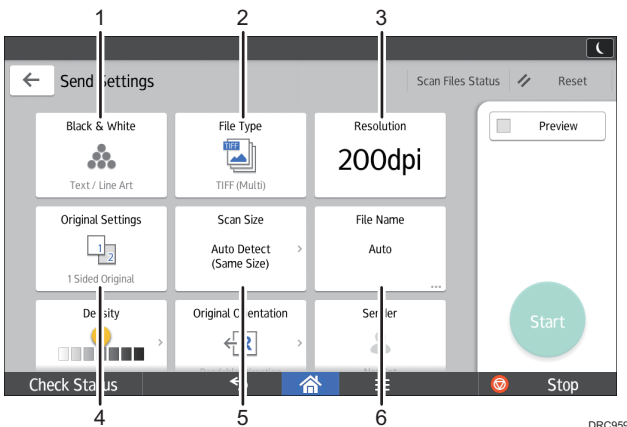



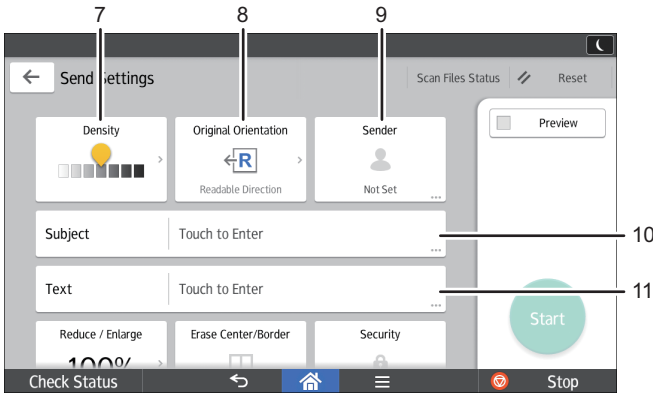

No.	Icon	Description
1		Press to select the settings that are appropriate for the type of your original and color mode.
2		Press to select a file type.
3	200 dpi	Press to select the resolution to scan the original.
4		Press to select the sides of the original to scan, such as one side or both sides.
5	Auto Detect (Same Size)	Press to select the scanning size of the original.
6	Auto	Press to specify a file name.

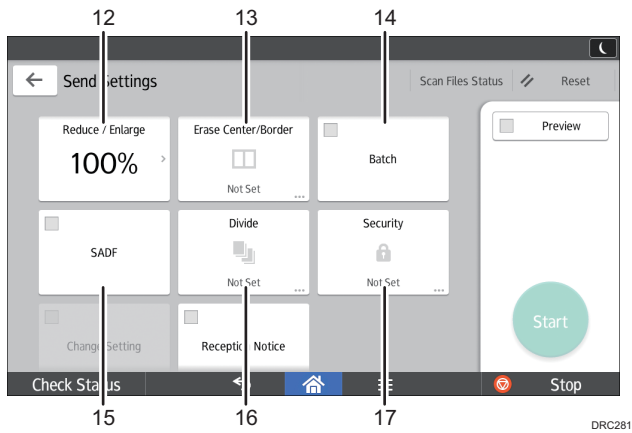

DRC960



No.	Icon	Description
7		Press to specify the density to scan the original. You can also specify the density by touching the yellow dot icon and dragging it right or left.
8		Press to select the orientation of the original.
9		Press to specify the sender.
10	Subject	Press to enter the subject of the e-mail.
11	Text	Press to enter the main text of the e-mail.

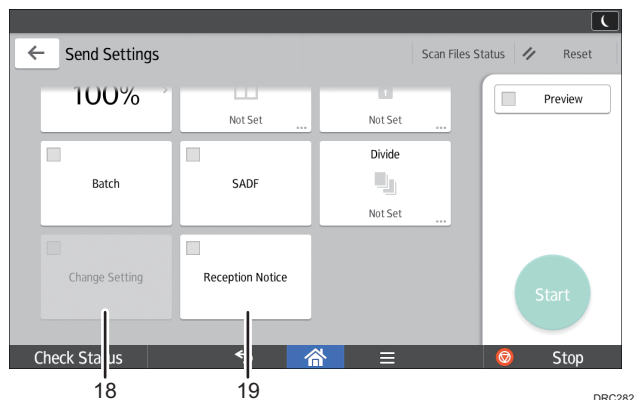

No.	Icon	Description
12	100%	Press to specify the magnification ratio for scanning the original.
13		Press to erase the image from a specified width around the document and in the center of the document when the document is scanned.
14	Batch	Press to scan a large number of originals in several batches and send them together as a single job. You can place multi-page originals in the ADF.
15	SADF	Press to scan a large number of originals in several batches and send them together as a single job. Place the originals in the ADF one by one.
16		Press to divide a multi-page original into parts of a specified number of pages each, and then send the documents.
17		Press to sign and encrypt the e-mail.



DRC282

No.	Icon	Description
18		To switch the scan setting for additional originals to [1 Sided Original] after scanning one side of the last page of a batch of two-sided originals using the exposure glass, press [Change Setting], and then press [1 Sided Original]. You can select this only if [Batch] or [SADF] is also selected.
19		Press this to notify the sender that the e-mail recipient has opened the e-mail.

Registering Functions in a Program (When Using the Standard Operation Panel)

The number of programs that can be registered is as follows:

- Copier: 25 programs
- Document Server: 25 programs
- Scanner: 25 programs

The following settings can be registered to programs:

Copier:

Color mode, original type, density, Original Settings, paper tray, Store File (except for User Name, File Name, and Password), Auto Reduce / Enlarge, Create Margin, ID Card Copy, Finishing, Cover/Slip Sheet, Edit / Color, Dup./Combine/Series, Reduce / Enlarge, number of copies

Document Server (on the initial document print screen):

Finishing, Cover/Slip Sheet (except for Main Sheets in Designate / Chapter), Edit / Stamp, 2 Sided / Book, number of prints

Scanner:

Scan Settings, density, Original Feed Type, Send File Type / Name (except for Security Settings and Start No.), Store File (except for User Name, File Name, and Password), Preview, Destinations selected from the Address Book, Text, Subject, Security, Receipt Notice, File Emailing Method

This section explains how to register functions in a program using copier function as an example.

1. Press the [Home] key on the bottom left of the control panel, and press the [Copier] icon on the [Home] screen.

If the [Copier] icon does not appear, press the  icon at the upper right corner of the screen to switch to the menu screen.

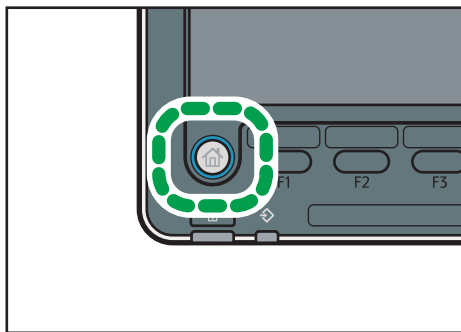

CUV108

2. Edit the copy settings so all functions you want to store in a program are selected.

3. Press the [Program] key.

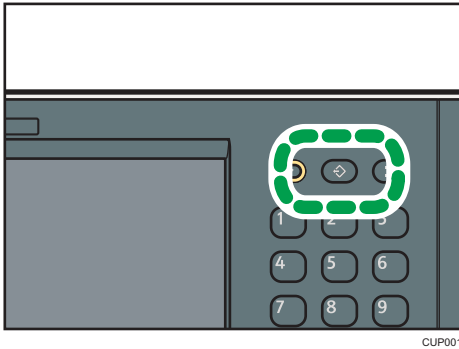

CUP001

4. Press [Program].

5. Press the program number you want to register.

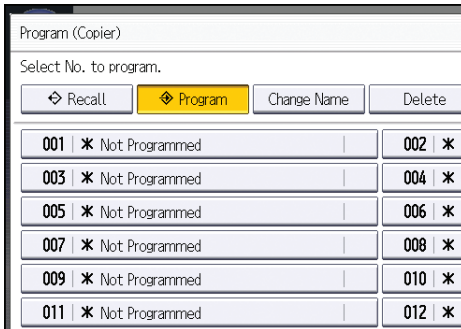

6. Enter the program name.

7. Press [OK].

8. Press [Exit].

Note

- You can enter up to 34 characters for a program name.
- When a specified program is registered as the default, its values become the default settings, which are displayed without pressing the [Program] key, when modes are cleared or reset, and after the machine is turned on. See "Changing the Default Functions of the Initial Screen", Convenient Functions.
- When the paper tray you specified in a program is empty and if there is more than one paper tray with the same size paper in it, the paper tray prioritized under [Paper Tray Priority: Copier] will be selected first. For details, see "System Settings", Connecting the Machine/ System Settings.
- Destinations can be registered to a program of the scanner mode only when [Include Destinations] is selected for [Program Setting for Destinations] in [Scanner Features]. For details about the setting, see "General Settings", Scan.

- Folder destinations that have protection codes cannot be registered to a program of the scanner mode.
- Programs are not deleted by turning the power off or by pressing the [Reset] key unless the program is deleted or overwritten.
- Program numbers with  next to them already have settings made for them.
- Programs can be registered to the [Home] screen, and can be recalled easily. For details, see page 51 "Registering a shortcut to a program to the [Home] screen (when using the standard operation panel)" and page 50 "Adding Icons to the [Home] Screen (When Using the Standard Operation Panel)". Shortcuts to programs stored in Document Server mode cannot be registered to the [Home] screen.

Example of Programs (When Using the Standard Operation Panel)

Copier mode

Program name	Program description	Effect
Eco copy	Specify [Combine 2 Sides] in [Dup./Combine/Series].	You can save paper and toner.
Dated confidential copy	In [Edit / Color], specify [CONFIDENTIAL] under [Preset Stamp], and [Date Stamp].	You can increase security awareness by printing "CONFIDENTIAL" and the date on copies.
Conference material copy	Specify [Combine 2 Sides] in [Dup./Combine/Series] and [Staple] in [Finishing].	You can copy conference materials efficiently.
Magazine copy	In [Dup./Combine/Series], specify [Magazine] under [Book], and also specify [Staple: Center] in [Finishing].	You can save paper. Also, you can perform printing jobs such as producing leaflets in-house instead of having them printed by an outside printing company.
Unified-size copy	Specify [Mixed Sizes] in [Original Settings] and [Auto Reduce / Enlarge] in the initial display.	You can print various size copies onto one size of paper, so they are easier to manage.
Z-folding copy	Specify [Z-fold] in [Finishing].	A3 size paper is folded to A4 size. You can print various size copies onto one size of paper, so they are easier to manage.

Program name	Program description	Effect
Stamping corporate name copy	Specify [User Stamp] in [Edit / Color].	You can stamp the name of your company on copies of working or architectural drawings. Your company name needs to be pre-registered in the machine.
Thumbnail copy	Specify [Combine 1 Side] in [Dup./Combine/Series].	You can copy up to eight pages onto one side of a sheet, so that you can save paper.
Storage copy: XXXX (replace XXXX by a folder name)	Specify a folder in [Target Folder to Store] in [Store File].	You can use folders to organize stored files by user name or intended use.

Scanner mode

Program name	Program description	Effect
Easy PDF scan	Select [Full Color: Text / Photo] in [Scan Settings]. In [Send File Type / Name], select [PDF] under [File Type] and enter the business details such as "London branch: daily report" under [File Name].	You can scan documents efficiently.
High compression PDF scan	Select [Full Color: Text / Photo] in [Scan Settings]. In [Send File Type / Name], specify [PDF] in [File Type], and also specify [High Compression PDF] in [PDF File Setting].	You can compress the data size of scanned documents, so that you can send and store them.
Long-term storage scan	In [Send File Type / Name], select [PDF] in [File Type] and [PDF/A] in [PDF File Setting].	You can easily digitize documents to "PDF/A" file format, which is suitable for long-term storage.
Unified-size scan	In [Scan Settings], select [Mixed Original Sizes] in [Scan Size] and specify the finished size of scanned data in [Reduce / Enlarge] under [Edit].	You can skip this procedure to unify the size when reprinting scanned data.

Program name	Program description	Effect
Digital signature scan	In [Send File Type / Name], specify [PDF] in [File Type], and also specify [Digital Signature].	You can add a digital signature to an important document such as a contract, so that any data tampering can be detected.
Dividing file scan	Specify [Divide] in [Original Feed Type].	You can scan a multiple page original as one file by splitting it into groups of a specified number of pages.
High resolution scan	In [Send File Type / Name], specify [TIFF] in [File Type]. Also, specify a higher resolution in [Scan Settings].	Scanned documents maintain much of the detail of the originals, but the size of the data may be quite large.
Batch document scan	Select [Batch] in [Original Feed Type].	You can apply multiple scans to a large volume of originals and send the scanned originals as a single job.
Scan to XXXX (replace XXXX by a destination name)	Select e-mail or folder destinations from the list that is registered in the machine's Address Book, and then specify the scan settings.	If you register destinations and scan settings that you use often, you can skip the procedures to specify them when sending a scanned file.
Storage scan: XXXX (replace XXXX by a folder name)	Specify a folder in [Target Folder to Store] in [Store File].	You can use folders to organize stored files by user name or intended use.

↓ Note

- Depending on the options installed, some functions cannot be registered. For details, see "Functions Requiring Optional Configurations", Getting Started.
- The names of programs given above are just examples. You can assign any name to a program according to your objectives.
- Depending on your business details or the type of documents to be scanned, registering a program cannot be recommended.

Registering Functions in a Program (When Using the Smart Operation Panel)

Depending on the functions, the number of programs that can be registered is different.

Standard Applications

- Copy: 25 programs
- Scanner: 100 programs

Quick Applications

- Quick Copy: 25 programs
- Quick Scanner: 100 programs

Classic Applications

- Copier (Classic): 25 programs
- Document Server: 25 programs
- Scanner (Classic): 25 programs

The following settings can be registered to programs:

Standard Applications

- Copy:
Color mode, Reduce/Enlarge, Quantity, Density, Paper Tray, 2 Sided, Combine, Sort, Stack, Staple, Punch, Fold, Original Size, Original Type, Batch, Other Settings
- Scanner:
Destination, Preview, Send Settings

Quick Applications

- Quick Copy:
Color mode, Paper Tray, Quantity, Reduce/Enlarge, 2 Sided, Combine, Staple, Punch, Density, Original Orientation
- Quick Scanner:
Destination, Original Type, File Type, Resolution, Original Orientation, Original Sides, Scan Size, Preview

Classic Applications

- Copier (Classic):
Color mode, original type, density, Original Settings, paper tray, Store File (except for User Name, File Name, and Password), Auto Reduce / Enlarge, Create Margin, ID Card Copy, Finishing, Cover/Slip Sheet, Edit / Color, Dup./Combine/Series, Reduce / Enlarge, number of copies

- Document Server (on the initial document print screen):
Finishing, Cover/Slip Sheet (except for Main Sheets in Designate / Chapter), Edit / Stamp, 2 Sided / Book, number of prints
- Scanner (Classic):
Scan Settings, density, Original Feed Type, Send File Type / Name (except for Security Settings and Start No.), Store File (except for User Name, File Name, and Password), Preview, Destinations selected from the Address Book, Text, Subject, Security, Receipt Notice, File Emailing Method

This section explains how to register functions to a program by using each application.

Standard Applications/Quick Applications

1. Edit the settings so all functions you want to register to a program are selected on the [Copy], [Scanner], [Quick Copy], or [Quick Scanner] screen.
2. Press [Menu] () at the bottom of the screen in the center.
3. Press [Reg. Current Setting to Progr..].
4. Press the program number you want to register.
5. Enter the program name.
6. Select the icon for the program.
You can select an image stored in the SD card.
7. Press [Prev. Screen].
When using the quick application, press [Back].
8. Press [OK].
9. Press [Place].
Even if you select [Do not Place], you can add shortcuts to the program to the [Home] screen after the program registration is complete.
10. Press [Exit].

Classic Applications

1. Edit the settings so all functions you want to register to a program are selected on the [Copier (Classic)], [Document Server], or [Scanner (Classic)] screen.
When using the Document Server, edit the settings on the initial document print screen.
2. Press [Recall/Program/Change Program] on the bottom left of the screen.
3. Press [Program].

4. Press the program number you want to register.

Program (Copier)	
Select No. to program.	
<input type="button" value="Recall"/> <input type="button" value="Program"/> <input type="button" value="Change Name"/> <input type="button" value="Delete"/>	
001 * Not Programmed	002 * Not Programmed
003 * Not Programmed	004 * Not Programmed
005 * Not Programmed	006 * Not Programmed
007 * Not Programmed	008 * Not Programmed
009 * Not Programmed	010 * Not Programmed
011 * Not Programmed	012 * Not Programmed

5. Enter the program name.

6. Press [OK].

7. Press [Exit].

↓ Note

- The number of characters you can enter for a program name varies depending on the functions as follows:
 - Standard Applications
 - Copy: 40 characters
 - Scanner: 40 characters
 - Quick Applications
 - Quick Copy: 40 characters
 - Quick Scanner: 40 characters
 - Classic Applications
 - Copier (Classic): 34 characters
 - Document Server: 34 characters
 - Scanner (Classic): 34 characters
- When a specified program is registered as the default, its values become the default settings, which are displayed without recalling the program, when modes are cleared or reset, and after the machine is turned on. See "Changing the Default Functions of the Initial Screen", Convenient Functions.
- When the paper tray you specified in a program is empty and if there is more than one paper tray with the same size paper in it, the paper tray prioritized under [Paper Tray Priority: Copier] in the [Tray Paper Settings] tab will be selected first. For details, see "General Features", Connecting the Machine/ System Settings.

- Destinations can be registered to a program of the scanner mode only when [Include Destinations] is selected for [Program Setting for Destinations] in [Scanner Features]. For details about the setting, see "General Settings", Scan.
- Folder destinations that have protection codes cannot be registered to a program of the scanner mode.
- Programs are not deleted by turning the power off or by pressing [Reset] unless the program is deleted or overwritten.
- You can use an image file that is 72 × 72 pixels as a program icon for Standard applications and Quick applications.
- When you are using the Classic Applications, program numbers with  next to them indicate that the programs have been registered.
- Programs can be registered to the [Home] screen, and can be recalled easily. For details, see page 61 "Adding Icons to the [Home] Screen (When Using the Smart Operation Panel)". Shortcuts to programs stored in Document Server mode cannot be registered to the [Home] screen.

Example of Programs (When Using the Smart Operation Panel)

Copier (Classic)

Program name	Program description	Effect
Eco copy	Specify [Combine 2 Sides] in [Dup./Combine/Series].	You can save paper and toner.
Dated confidential copy	In [Edit / Color], specify [CONFIDENTIAL] under [Preset Stamp], and [Date Stamp].	You can increase security awareness by printing "CONFIDENTIAL" and the date on copies.
Conference material copy	Specify [Combine 2 Sides] in [Dup./Combine/Series] and [Staple] in [Finishing].	You can copy conference materials efficiently.
Magazine copy	In [Dup./Combine/Series], specify [Magazine] under [Book], and also specify [Staple: Center] in [Finishing].	You can save paper. Also, you can perform printing jobs such as producing leaflets in-house instead of having them printed by an outside printing company.
Unified-size copy	Specify [Mixed Sizes] in [Original Settings] and [Auto Reduce / Enlarge] in the initial display.	You can print various size copies onto one size of paper, so they are easier to manage.

Program name	Program description	Effect
Z-folding copy	Specify [Z-fold] in [Finishing].	A3 size paper is folded to A4 size. You can print various size copies onto one size of paper, so they are easier to manage.
Stamping corporate name copy	Specify [User Stamp] in [Edit / Color].	You can stamp the name of your company on copies of working or architectural drawings. Your company name needs to be pre-registered in the machine.
Thumbnail copy	Specify [Combine 1 Side] in [Dup./ Combine/Series].	You can copy up to eight pages onto one side of a sheet, so that you can save paper.
Storage copy: XXXX (replace XXXX by a folder name)	Specify a folder in [Target Folder to Store] in [Store File].	You can use folders to organize stored files by user name or intended use.

Scanner (Classic)

Program name	Program description	Effect
Easy PDF scan	Select [Full Color: Text / Photo] in [Scan Settings]. In [Send File Type / Name], select [PDF] under [File Type] and enter the business details such as "London branch: daily report" under [File Name].	You can scan documents efficiently.
High compression PDF scan	Select [Full Color: Text / Photo] in [Scan Settings]. In [Send File Type / Name], specify [PDF] in [File Type], and also specify [High Compression PDF] in [PDF File Setting].	You can compress the data size of scanned documents, so that you can send and store them.
Long-term storage scan	In [Send File Type / Name], select [PDF] in [File Type] and [PDF/A] in [PDF File Setting].	You can easily digitize documents to "PDF/A" file format, which is suitable for long-term storage.

Program name	Program description	Effect
Unified-size scan	In [Scan Settings], select [Mixed Original Sizes] in [Scan Size] and specify the finished size of scanned data in [Reduce / Enlarge] under [Edit].	You can skip this procedure to unify the size when reprinting scanned data.
Digital signature scan	In [Send File Type / Name], specify [PDF] in [File Type], and also specify [Digital Signature].	You can add a digital signature to an important document such as a contract, so that any data tampering can be detected.
Dividing file scan	Specify [Divide] in [Original Feed Type].	You can scan a multiple page original as one file by splitting it into groups of a specified number of pages.
High resolution scan	In [Send File Type / Name], specify [TIFF] in [File Type]. Also, specify a higher resolution in [Scan Settings].	Scanned documents maintain much of the detail of the originals, but the size of the data may be quite large.
Batch document scan	Select [Batch] in [Original Feed Type].	You can apply multiple scans to a large volume of originals and send the scanned originals as a single job.
Scan to XXXX (replace XXXX by a destination name)	Select e-mail or folder destinations from the list that is registered in the machine's Address Book, and then specify the scan settings.	If you register destinations and scan settings that you use often, you can skip the procedures to specify them when sending a scanned file.
Storage scan: XXXX (replace XXXX by a folder name)	Specify a folder in [Target Folder to Store] in [Store File].	You can use folders to organize stored files by user name or intended use.

Note

- Depending on the options installed, some functions cannot be registered. For details, see "Functions Requiring Optional Configurations", Getting Started.
- The names of programs given above are just examples. You can assign any name to a program according to your objectives.

- Depending on your business details or the type of documents to be scanned, registering a program cannot be recommended.

Turning On/Off the Power

★ Important

- When you push the main power switch, wait at least 10 seconds after it is confirmed that the main power indicator has lit up or gone out.

The main power switch is on the left side of the machine. When this switch is turned on, the main power turns on and the main power indicator on the right side of the control panel lights up. When this switch is turned off, the main power turns off and the main power indicator goes out. When this is done, machine power is off. Use this switch only when necessary.

Confirm how much power the options draw, and then plug them into an outlet that is nearby but separate from the outlet that the main machine is plugged into.

2

Turning On the Main Power

1. Make sure the power cord is firmly plugged into the wall outlet.
2. Open the main power switch cover, and push the main power switch.

The main power indicator goes on.

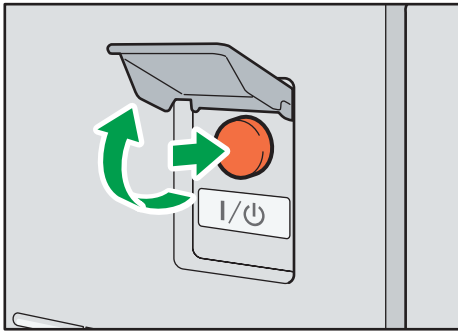

Turning Off the Main Power

⚠ CAUTION

- When disconnecting the power cord from the wall outlet, always pull the plug, not the cord. Pulling the cord can damage the power cord. Use of damaged power cords could result in fire or electric shock.

★ Important

- Do not turn off the power while the machine is in operation.

- **Do not hold down the main power switch while turning off the main power. Doing so forcibly turns off the machine's power and may damage the hard disk or memory and cause malfunctions.**

1. Open the main power switch cover, and push the main power switch.

The main power indicator goes out. The main power turns off automatically when the machine shuts down. If the screen on the control panel does not disappear, contact your service representative.

Logging In the Machine

When the Authentication Screen is Displayed

If Basic Authentication, Windows Authentication, or LDAP Authentication is active, the authentication screen appears on the display. The machine only becomes operable after entering your own Login User Name and Login Password. If User Code Authentication is active, you cannot use the machine until you enter the User Code.

If you can use the machine, you can say that you are logged in. When you go out of the operable state, you can say that you are logged out. After logging in the machine, be sure to log out of it to prevent unauthorized usage.

★ Important

- Ask the user administrator for the Login User Name, Login Password, and User Code. For details about user authentication, see "Configuring User Authentication", Security Guide.
- User Code to enter on User Code Authentication is the numerical value registered in the Address Book as "User Code".

User Code Authentication Using the Control Panel

If User Code Authentication is active, a screen prompting you to enter a User Code appears.

1. Enter a User Code (up to eight digits), and then press [OK].

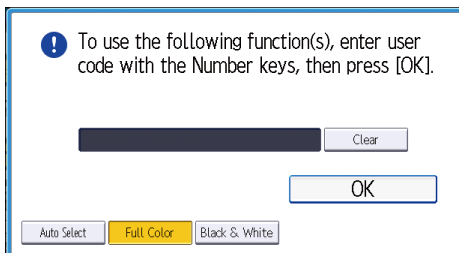

Logging In Using the Control Panel (When Using the Standard Operation Panel)

This section explains the procedure for logging in to the machine when Basic Authentication, Windows Authentication, or LDAP Authentication is set.

1. Press [Login].



2. Enter a Login User Name, and then press [OK].

3. Enter a Login Password, and then press [OK].

When the user is authenticated, the screen for the function you are using appears.

Logging In Using the Control Panel (When Using the Smart Operation Panel)

This section explains the procedure for logging in to the machine when Basic Authentication, Windows Authentication, or LDAP Authentication is set.

1. Press [Login] on the top right on the screen.

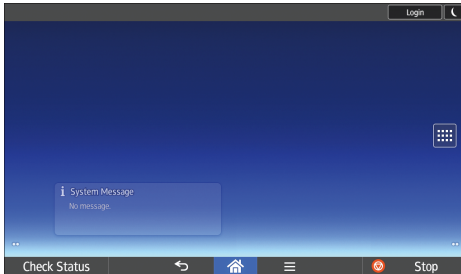

2. Press [User Name].

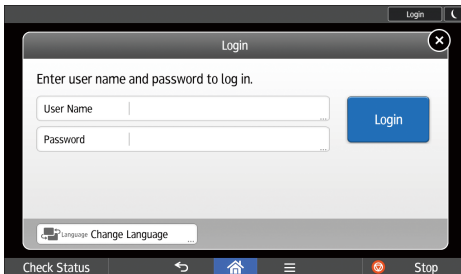

3. Enter a Login User Name, and then press [Done].

4. Press [Password].

5. Enter a Login Password, and then press [Done].

6. Press [Login].

Logging Out Using the Control Panel (When Using the Standard Operation Panel)

This section explains the procedure for logging out the machine when Basic Authentication, Windows Authentication, or LDAP Authentication is set.

★ Important

- To prevent use of the machine by unauthorized persons, always log out when you have finished using the machine.

1. Press the [Login/Logout] key.



DRC133

2. Press [Yes].

Logging Out Using the Control Panel (When Using the Smart Operation Panel)

This section explains the procedure for logging out the machine when Basic Authentication, Windows Authentication, or LDAP Authentication is set.

★ Important

- To prevent use of the machine by unauthorized persons, always log out when you have finished using the machine.

1. Press [Logout] on the top right on the screen.



2. Press [OK].

Placing Originals

Placing Originals on the Exposure Glass

⚠ CAUTION

- Keep your hands away from the hinges and exposure glass when lowering the ADF. Not doing so may result in an injury if your hands or fingers are pinched.

★ Important

- Do not lift the ADF forcefully. Otherwise, the cover of the ADF might open or be damaged.

1. Lift the ADF.

Be sure to lift the ADF by more than 30 degrees. Otherwise, the size of the original might not be detected correctly.

2. Place the original face down on the exposure glass. The original should be aligned to the rear left corner.

Start with the first page to be scanned.

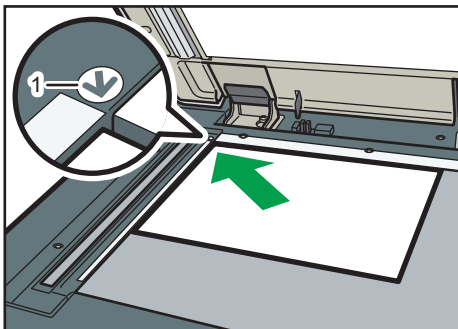

DRC151

1. Positioning mark

3. Lower the ADF.

Placing Originals in the Auto Document Feeder

Be sure not to load the original untidily. Doing so may cause the machine to display a paper misfeed message. Also, be sure not to place originals or other objects on the top cover. Doing so may cause a malfunction.

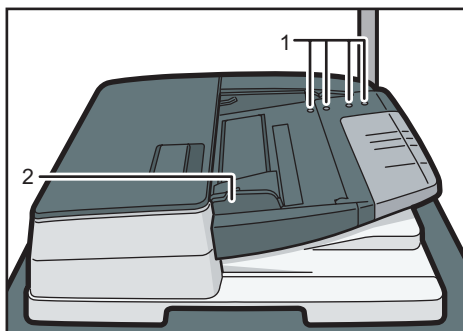

DRC167

1. Sensors**2. Original guide****1. Adjust the original guide to the original size.****2. Place the aligned originals squarely face up in the ADF.**

Do not stack originals beyond the limit mark.

The first page should be on the top.



DRC168

1. Limit mark

3. Copy

This chapter describes the basic procedure for making copies.

Basic Procedure

To make copies of originals, place them on the exposure glass or in the ADF.

When placing the original on the exposure glass, start with the first page to be copied. When placing the original in the ADF, place them so that the first page is on the top.

About placing the original on the exposure glass, see Paper Specifications and Adding Paper for details.

About placing the original in the ADF, see Paper Specifications and Adding Paper for details.

To copy onto paper other than plain paper, specify the paper type in [Tray Paper Settings] according to the weight of the paper you are using. For details, see "Changing Tray Paper Settings", Paper Settings.

When using the standard operation panel

For details about how to use this function, see page 93 "Basic Procedure (Classic)".

When using the Smart Operation Panel

You can use this function from the Copy Application and Copier (Classic) Application.

When Using the Copy Application

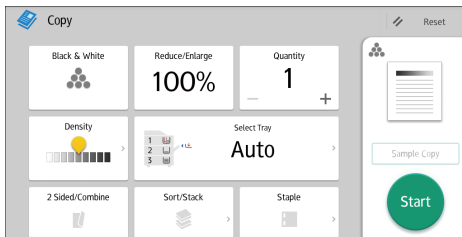

About how to use the application's screen, see page 65 "[Copy] Screen (When Using the Smart Operation Panel)".

When Using the Copier (Classic) Application

For details about how to use the Classic Copier function, see page 93 "Basic Procedure (Classic)".

Basic Procedure (Classic)

1. Display the initial copy screen.

- When using the standard operation panel
 1. Press the [Home] key on the control panel.

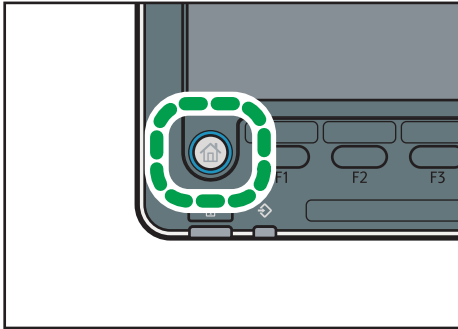

CUV108

2. Press the [Copier] icon on the screen.

If the [Copier] icon does not appear, press the  icon at the upper right corner of the screen to switch to the menu screen.

- When using the Smart Operation Panel
 1. Press [Home] () at the bottom of the screen in the center.
 2. Press the [Copier (Classic)] icon on the [Home] screen.

2. Make sure that no previous settings remain.

When there are previous settings remaining, press the [Reset] key.

3. Place the originals.

4. Make desired settings.

5. Enter the number of copies with the number keys.

The maximum copy quantity that can be entered is 9999.

6. Press the [Start] key.

When placing the original on the exposure glass, press the [#] key after all originals are scanned. Some functions such as Batch mode may require that you press the [#] key when placing originals in the ADF.

Follow the messages that appear on screen.

7. When the copy job is finished, press the [Reset] key to clear the settings.

Auto Reduce / Enlarge

The machine automatically detects the original size and then selects an appropriate reproduction ratio based on the paper size you select.

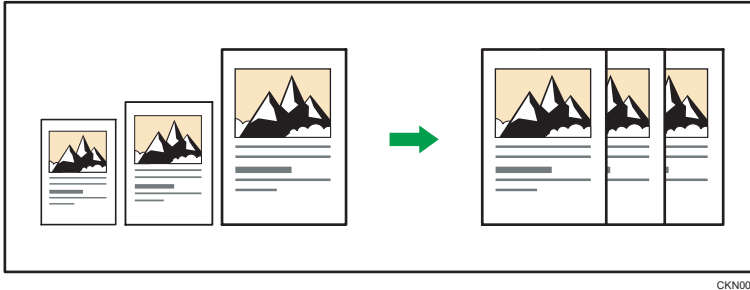

CKN008

★ Important

- If you select a reproduction ratio after pressing [Auto Reduce / Enlarge], [Auto Reduce / Enlarge] is canceled and the image cannot be rotated automatically.

This is useful to copy different size originals to the same size paper.

If the orientation in which your original is placed is different from that of the paper you are copying onto, the machine rotates the original image by 90 degrees and fits it on the copy paper (Rotate Copy). For example, to reduce A3 (11×17) \square originals to fit onto A4 ($8\frac{1}{2} \times 11$) \square paper, select a paper tray containing A4 ($8\frac{1}{2} \times 11$) \square paper, and then press [Auto Reduce / Enlarge]. The image is automatically rotated. For details about Rotate Copy, see "Rotate Copy", Copy/ Document Server.

The original sizes and orientations you can use with this function are as follows:

Region A (mainly Europe)

Original location	Original size and orientation
Exposure glass	A3 \square , B4 JIS \square , A4 \square , B5 JIS \square , A5 \square , $8\frac{1}{2} \times 13$ \square
ADF	A3 \square , B4 JIS \square , A4 \square , B5 JIS \square , A5 \square , B6 JIS \square , 11×17 \square , $8\frac{1}{2} \times 11$ \square , $8\frac{1}{2} \times 13$ \square

Region B (mainly North America)

Original location	Original size and orientation
Exposure glass	11×17 \square , $8\frac{1}{2} \times 14$ \square ^{*1} , $8\frac{1}{2} \times 13\frac{2}{5}$ \square ^{*1} , $8\frac{1}{2} \times 11$ \square , $5\frac{1}{2} \times 8\frac{1}{2}$ \square

Original location	Original size and orientation
ADF	11 × 17□, 8 ¹ / ₂ × 14□*1, 8 ¹ / ₂ × 13 ² / ₅ □*1, 8 ¹ / ₂ × 11□, 5 ¹ / ₂ × 8 ¹ / ₂ □, 10 × 14□, 7 ¹ / ₄ × 10 ¹ / ₂ □, A3□, A4□

*1 You can switch the initial setting to determine whether the machine detects either 8¹/₂ × 14□ or 8¹/₂ × 13²/₅□.

3

When using the standard operation panel

For details about how to use this function, see page 96 "Procedure for Auto Reduce / Enlarge (Classic)".

When using the Smart Operation Panel

You can use this function from the Copy Application and Copier (Classic) Application.

 **When Using the Copy Application**

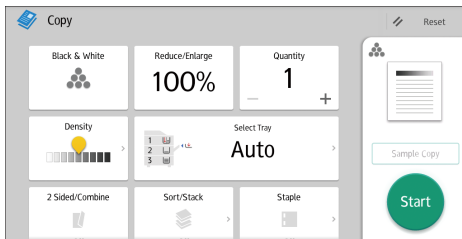

About how to use the application's screen, see page 65 "[Copy] Screen (When Using the Smart Operation Panel)".

 **When Using the Copier (Classic) Application**

For details about how to use the Classic Copier function, see page 96 "Procedure for Auto Reduce / Enlarge (Classic)".

Procedure for Auto Reduce / Enlarge (Classic)

1. Press [Auto Reduce / Enlarge].

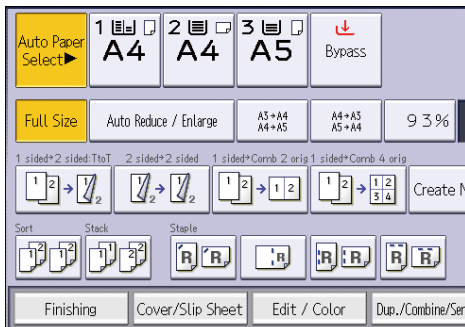

2. Select the paper size.
3. Place the originals, and then press the [Start] key.

Duplex Copying

Copies two 1-sided pages or one 2-sided page onto a 2-sided page. During copying, the image is shifted to allow for the binding margin.

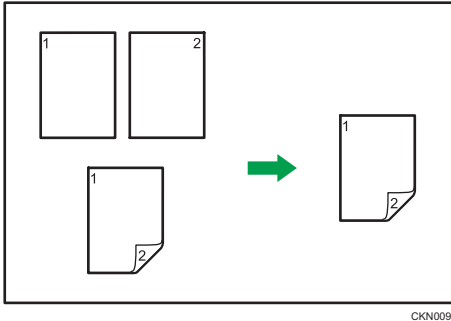

CKN009

There are two types of Duplex.

1 Sided → 2 Sided

Copies two 1-sided pages on one 2-sided page.

2 Sided → 2 Sided

Copies one 2-sided page on one 2-sided page.

The resulting copy image will differ according to the orientation in which you place your originals (☐ or ☐).

Original orientation and completed copies

To copy on both sides of the paper, select the original and copy orientation according to how you want the printout to appear.

Original	Placing originals	Original Orientation	Orientation	Copy
			Top to Top	
			Top to Bottom	

Original	Placing originals	Original Orientation	Orientation	Copy
			Top to Top	
			Top to Bottom	

When using the standard operation panel

For details about how to use this function, see page 100 "Procedure for Duplex Copying (Classic)".

When using the Smart Operation Panel

You can use this function from the Copy Application and Copier (Classic) Application.

When Using the Copy Application

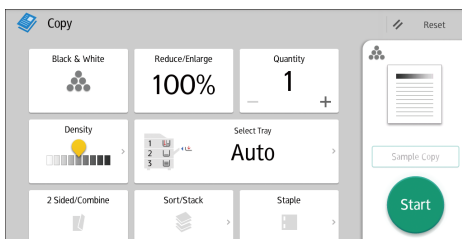

About how to use the application's screen, see page 65 "[Copy] Screen (When Using the Smart Operation Panel)".

When Using the Copier (Classic) Application

For details about how to use the Classic Copier function, see page 100 "Procedure for Duplex Copying (Classic)".

Procedure for Duplex Copying (Classic)

1. Press [Dup./Combine/Series].

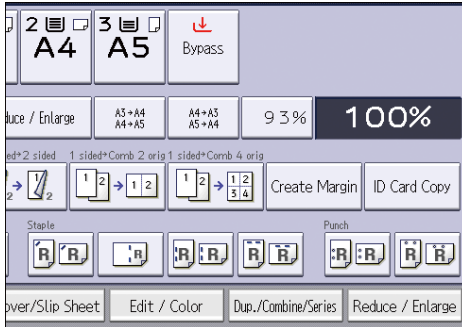

2. Make sure that [Duplex] is selected.

3. Select [1 Sided → 2 Sided] or [2 Sided → 2 Sided] according to how you want the document to be output.

To change the original or copy orientation, press [Orientation].

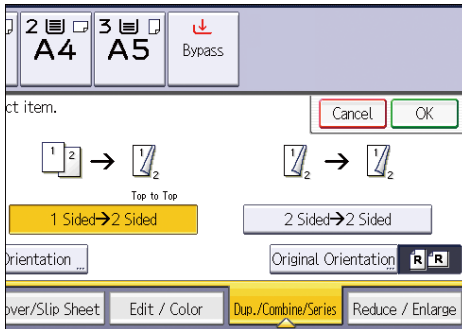

4. Press [Original Orientation].

5. Select the original orientation, and then press [OK] twice.

6. Place the originals, and then press the [Start] key.

Specifying the Original and Copy Orientation

Select the orientation of the originals and copies if the original is two-sided or if you want to copy onto both sides of the paper.

- Top to Top

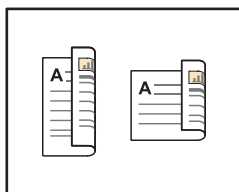

CKN011

- Top to Bottom



CKN012

When using the standard operation panel

For details about how to use this function, see page 101 "Procedure for specifying the original and copy orientation (classic)".

When using the Smart Operation Panel

You can use this function from the Copy Application and Copier (Classic) Application.

When Using the Copy Application

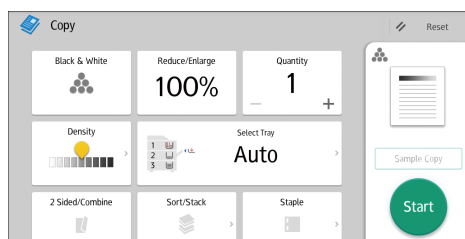

About how to use the application's screen, see page 65 "[Copy] Screen (When Using the Smart Operation Panel)".

When Using the Copier (Classic) Application

For details about how to use the Classic Copier function, see page 101 "Procedure for specifying the original and copy orientation (classic)".

Procedure for specifying the original and copy orientation (classic)

1. Press [Orientation].

2. Select [Top to Top] or [Top to Bottom] for [Original:] if the original is two-sided.

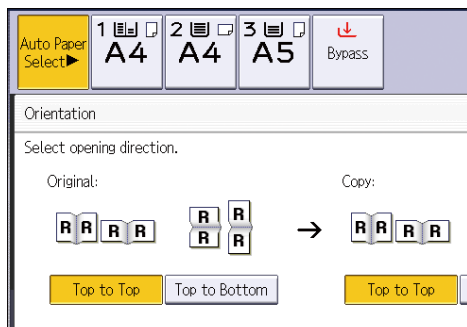

3. Select [Top to Top] or [Top to Bottom] for [Copy:].
4. Press [OK].

Combined Copying

This mode can be used to select a reproduction ratio automatically and copy the originals onto a single sheet of copy paper.

The machine selects a reproduction ratio between 25 and 400%. If the orientation of the original is different from that of the copy paper, the machine will automatically rotate the image by 90 degrees to make copies properly.

Orientation of the original and image position of Combine

The image position of Combine differs according to original orientation and the number of originals to be combined.

- Portrait (📄) originals

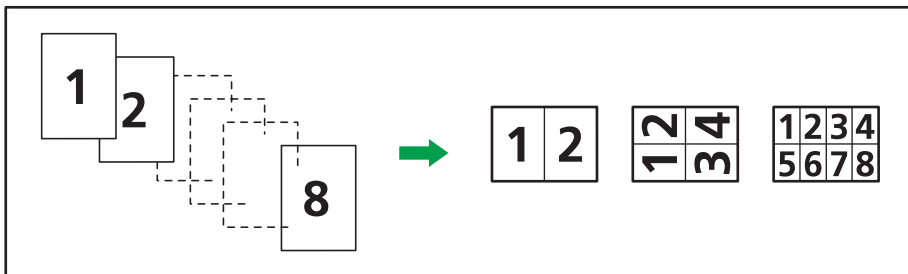

CKN015

- Landscape (📄) originals

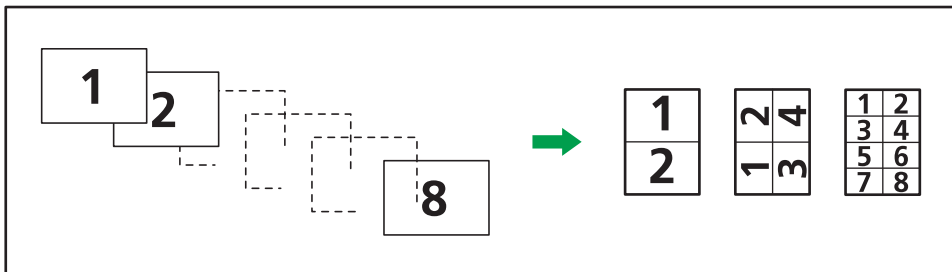

CKN016

Placing originals (originals placed in the ADF)

The default value for the copy order in the Combine function is [From Left to Right]. To copy originals from right to left in the ADF, place them upside down.

- Originals read from left to right

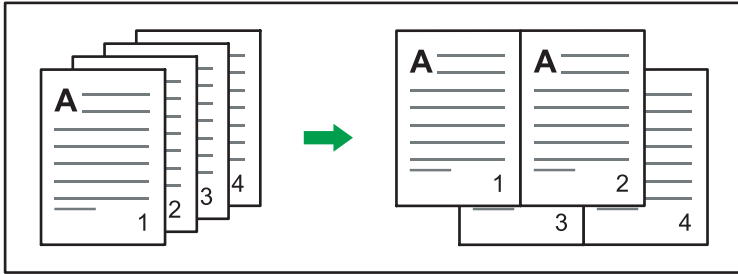

CKN010

- Originals read from right to left

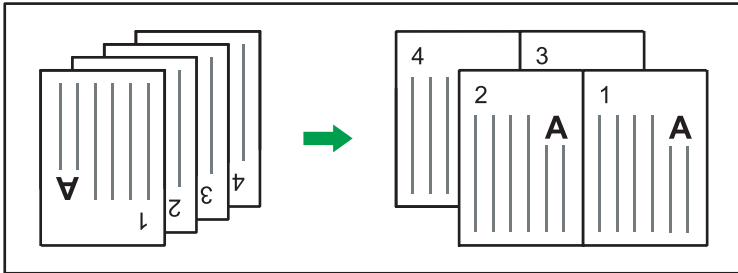

CKN017

One-Sided Combine

Combine several pages onto one side of a sheet.



CKN014

There are six types of One-Sided Combine.

1 Sided 2 Originals → Combine 1 Side

Copies two 1-sided originals to one side of a sheet.

1 Sided 4 Originals → Combine 1 Side

Copies four 1-sided originals to one side of a sheet.

1 Sided 8 Originals → Combine 1 Side

Copies eight 1-sided originals to one side of a sheet.

2 Sided 2 Pages → Combine 1 Side

Copies one 2-sided original to one side of a sheet.

2 Sided 4 Pages → Combine 1 Side

Copies two 2-sided originals to one side of a sheet.

2 Sided 8 Pages → Combine 1 Side

Copies four 2-sided originals to one side of a sheet.

When using the standard operation panel

For details about how to use this function, see page 105 "Procedure for one-sided combine (classic)".

When using the Smart Operation Panel

You can use this function from the Copy Application and Copier (Classic) Application.

When Using the Copy Application

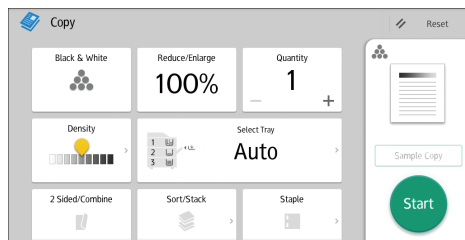

About how to use the application's screen, see page 65 "[Copy] Screen (When Using the Smart Operation Panel)".

When Using the Copier (Classic) Application

For details about how to use the Classic Copier function, see page 105 "Procedure for one-sided combine (classic)".

Procedure for one-sided combine (classic)

1. Press [Dup./Combine/Series].

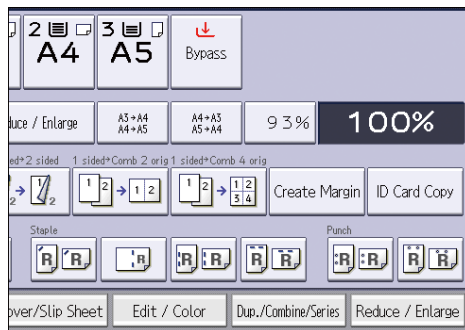

2. Press [Combine].

3. Select [1 Sided] or [2 Sided] for [Original:].

If you selected [2 Sided], you can change the orientation.

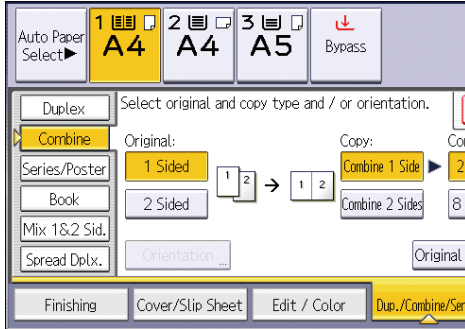

- 4. Press [Combine 1 Side].
- 5. Select the number of originals to combine.
- 6. Press [Original Orientation].
- 7. Select the original orientation, and then press [OK] twice.
- 8. Select the paper size.
- 9. Place the originals, and then press the [Start] key.

Two-Sided Combine

Combines various pages of originals onto two sides of one sheet.

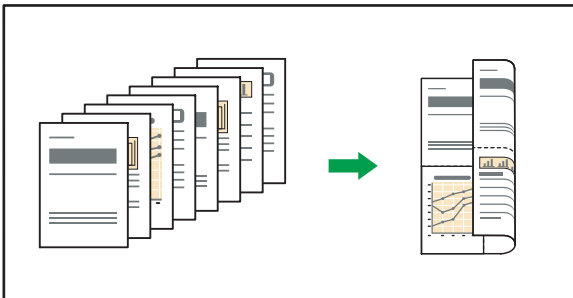

CKN074

There are six types of Two-Sided Combine.

1 Sided 4 Originals → Combine 2 Sides

Copies four 1-sided originals to one sheet with 2 pages per side.

1 Sided 8 Originals → Combine 2 Sides

Copies eight 1-sided originals to one sheet with 4 pages per side.

1 Sided 16 Originals → Combine 2 Sides

Copies 16 1-sided originals to one sheet with 8 pages per side.

2 Sided 4 Pages → Combine 2 Sides

Copies two 2-sided originals to one sheet with 2 pages per side.

2 Sided 8 Pages → Combine 2 Sides

Copies four 2-sided originals to one sheet with 4 pages per side.

2 Sided 16 Pages → Combine 2 Sides

Copies eight 2-sided originals to one sheet with 8 pages per side.

When using the standard operation panel

For details about how to use this function, see page 108 "Procedure for two-sided combine (classic)".

When using the Smart Operation Panel

You can use this function from the Copy Application and Copier (Classic) Application.

When Using the Copy Application

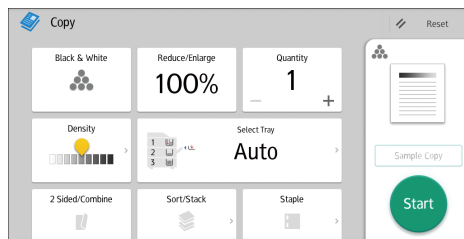

About how to use the application's screen, see page 65 "[Copy] Screen (When Using the Smart Operation Panel)".

When Using the Copier (Classic) Application

For details about how to use the Classic Copier function, see page 108 "Procedure for two-sided combine (classic)".

Procedure for two-sided combine (classic)

1. Press [Dup./Combine/Series].

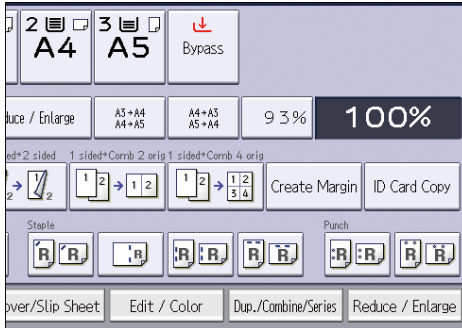

2. Press [Combine].
3. Select [1 Sided] or [2 Sided] for [Original:].

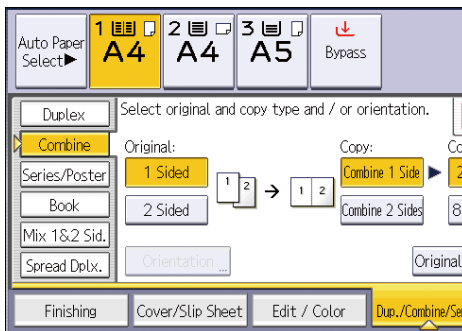

4. Press [Combine 2 Sides].
5. Press [Orientation].
6. Select [Top to Top] or [Top to Bottom] for [Original:] if the original is two-sided.
7. Select [Top to Top] or [Top to Bottom] for [Copy:], and then press [OK].
8. Under [Combine:], specify the number of originals to be combined.
9. Press [Original Orientation].
10. Select the original orientation, and then press [OK] twice.
11. Select the paper size.
12. Place the originals, and then press the [Start] key.

Copying onto Custom Size Paper

Sizes of paper that can be fed from the bypass tray are as follows:

- When the multi bypass banner sheet tray or the banner sheet guide tray is installed:
Horizontal length: 139.7–700.0 mm (5.50–27.55 inches), vertical length: 90.0–330.2 mm (3.55–13.00 inches)
- When the multi bypass banner sheet tray or the banner sheet guide tray is not installed:
Horizontal length: 139.7–487.7 mm (5.50–19.20 inches), vertical length: 90.0–330.2 mm (3.55–13.00 inches)

Note however that the limitation on the horizontal and vertical length range will vary depending on which options are installed.

- When prints are delivered to the upper tray of Finisher SR5070 or Booklet Finisher SR5080:
Horizontal length: 139.7–487.7 mm (5.50–19.20 inches), vertical length: 100.0–330.2 mm (3.94–13.00 inches)
When the SR5000 series output tray for banner sheet is installed, you can copy onto paper that has a horizontal length of 139.7–700.0 mm (5.50–27.55 inches).
- When prints are delivered to the shift tray of Finisher SR5070 or Booklet Finisher SR5080:
Horizontal length: 139.7–487.7 mm (5.50–19.20 inches), vertical length: 139.7–330.2 mm (5.50–13.00 inches)
When the SR5000 series output tray for banner sheet is installed, you can copy onto paper that has a horizontal length of 139.7–700.0 mm (5.50–27.55 inches).
- When prints are delivered to the upper tray or the shift tray of Finisher SR4120 or Booklet Finisher SR4130:
Horizontal length: 139.7–487.7 mm (5.50–19.20 inches), vertical length: 90.0–330.2 mm (3.55–13.00 inches)
When the SR4000 series output tray for banner sheet is installed, you can copy onto paper that has a horizontal length of 139.7–700.0 mm (5.50–27.55 inches)

When using the standard operation panel

For details about how to use this function, see page 110 "Procedure for Copying onto Custom Size Paper (Classic)".

When using the Smart Operation Panel

You can use this function from the Copy Application and Copier (Classic) Application.

When Using the Copy Application

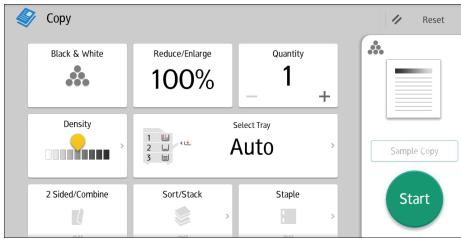

About how to use the application's screen, see page 65 "[Copy] Screen (When Using the Smart Operation Panel)".

When Using the Copier (Classic) Application

For details about how to use the Classic Copier function, see page 110 "Procedure for Copying onto Custom Size Paper (Classic)".

Procedure for Copying onto Custom Size Paper (Classic)

1. Load the paper face up in the bypass tray.
The bypass tray () is automatically selected.
2. Press the [#] key.
3. Press [Paper Size].
4. Press [Custom Size].
5. Enter the horizontal size with the number keys, and then press [#].

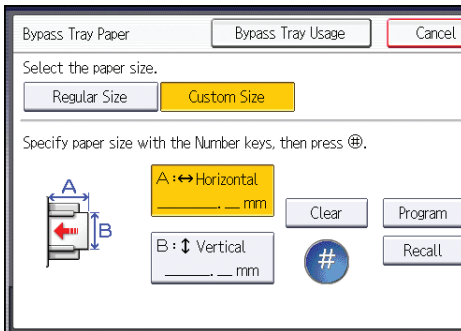

6. Enter the vertical size with the number keys, and then press [#].
7. Press [OK] twice.
8. Place the originals, and then press the [Start] key.

Copying onto Envelopes

This section describes how to copy onto regular size and custom size envelopes. Place the original on the exposure glass and place the envelope in the bypass tray, paper trays, or the wide LCT.

Specify the thickness of the paper according to the weight of the envelopes you are printing on. For details about the relationship between paper weight and paper thickness and the sizes of envelopes that can be used, see "Recommended Paper Sizes and Types", Paper Specifications and Adding Paper.

About handling envelopes, supported envelope types, and how to load envelopes, see Paper Specifications and Adding Paper for details.

★ Important

- **The Duplex function cannot be used with envelopes. If the Duplex function is specified, press [1 sided → 2 sided:TtoT] to cancel the setting.**

To copy onto custom size envelopes, you must specify the envelope's dimensions. Specify the horizontal and vertical length of the envelope.

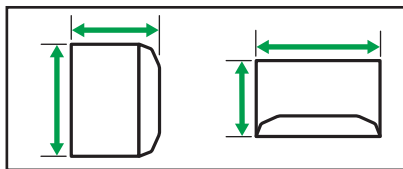
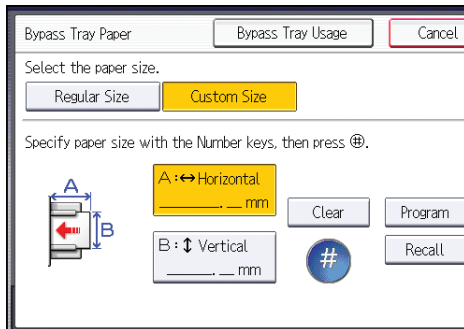

CJF005

↔: Horizontal

↕: Vertical

Be sure to include the fully open flap in the horizontal dimension.

When using the standard operation panel

For details about how to use this function, see page 112 "Procedure for Copying onto Envelopes from the Bypass Tray (Classic)".

When using the Smart Operation Panel

You can use this function from the Copy Application and Copier (Classic) Application.

When Using the Copy Application

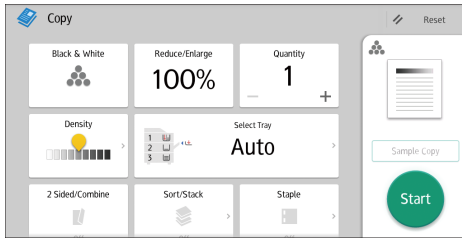

3

About how to use the application's screen, see page 65 "[Copy] Screen (When Using the Smart Operation Panel)".

When Using the Copier (Classic) Application

For details about how to use the Classic Copier function, see page 112 "Procedure for Copying onto Envelopes from the Bypass Tray (Classic)" and page 112 "Procedure for Copying onto Envelopes from the Paper Tray or the Wide LCT (Classic)".

Procedure for Copying onto Envelopes from the Bypass Tray (Classic)

1. Load the envelopes face up in the bypass tray.
The bypass tray () is automatically selected.
2. Press the [#] key.
3. Press [Paper Size].
4. Specify the envelope size, and then press [OK].
5. Press [Paper Type].
6. Select [Envelope].
7. Press [OK] twice.
8. Place the originals, and then press the [Start] key.

Procedure for Copying onto Envelopes from the Paper Tray or the Wide LCT (Classic)

Before using this function, specify the paper size and type under [Tray Paper Settings]. For the paper type, select [Envelope]. For details, see "Changing Tray Paper Settings", Paper Settings.

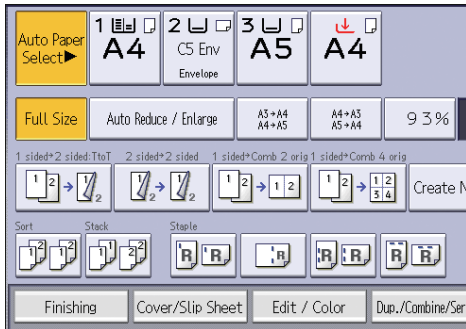
1. Select the paper tray where the envelopes are loaded.**2. Place the originals, and then press the [Start] key.**

Sort

The machine assembles copies as sets in sequential order.

Depending on your model and which options are installed on it, some of these functions might not be available. For details, see "Functions Requiring Optional Configurations", Getting Started.

★ Important

- You cannot use the bypass tray with Rotate Sort.

3

Sort/Shift Sort

Copies are assembled as sets in sequential order.

To use Shift Sort, a finisher is required. Each time the copies of one set or a job are delivered, the next copy is shifted to separate each set or job.



CKN018

Rotate Sort

Every other copy set is rotated by 90 degrees (⌛) and delivered to the copy tray.

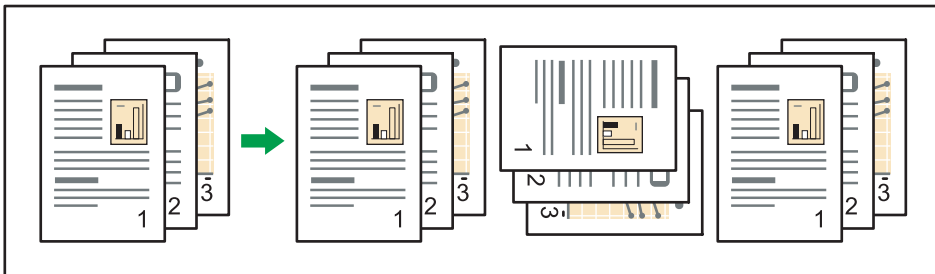

CKN019

To use the Rotate Sort function, two paper trays loaded with paper of the same size and type, but in different orientation (⌛), are required.

For details, see "Changing Tray Paper Settings", Paper Settings.

When using the standard operation panel

For details about how to use this function, see page 115 "Procedure for Sort (Classic)".

When using the Smart Operation Panel

You can use this function from the Copy Application and Copier (Classic) Application.

When Using the Copy Application

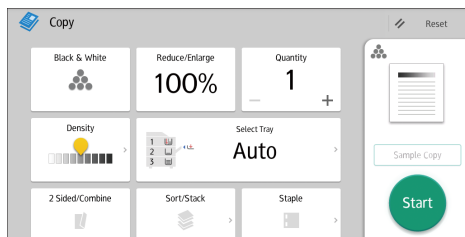

About how to use the application's screen, see page 65 "[Copy] Screen (When Using the Smart Operation Panel)".

When Using the Copier (Classic) Application

For details about how to use the Classic Copier function, see page 115 "Procedure for Sort (Classic)".

3

Procedure for Sort (Classic)

1. Press [Finishing].

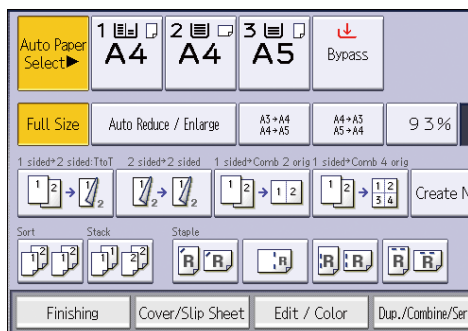

2. Press [Finisher].

3. Select [Sort] or [Rotate Sort], and then press [OK].

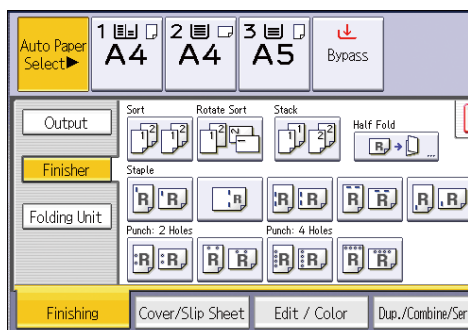

4. Enter the number of copy sets using the number keys.

5. Place the originals.

To confirm the type of finishing, press the [Sample Copy] key.

6. Press the [Start] key.

Changing the Number of Sets

You can change the number of copy sets during copying.

★ Important

- This function can be used only when the Sort function is selected.

When using the standard operation panel

For details about how to use this function, see page 116 "Procedure for changing the number of sets (classic)".

When using the Smart Operation Panel

You can use this function from the Copy Application and Copier (Classic) Application.

📄 When Using the Copy Application

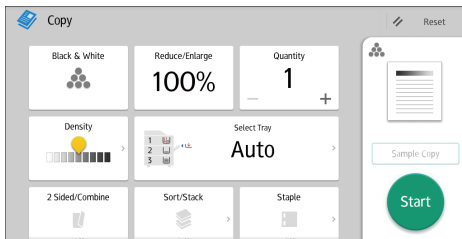

About how to use the application's screen, see page 65 "[Copy] Screen (When Using the Smart Operation Panel)".

📄 When Using the Copier (Classic) Application

For details about how to use the Classic Copier function, see page 116 "Procedure for changing the number of sets (classic)".

Procedure for changing the number of sets (classic)

1. While "Copying..." is displayed, press the [Stop] key.

2. Enter the number of copy sets with the number keys.

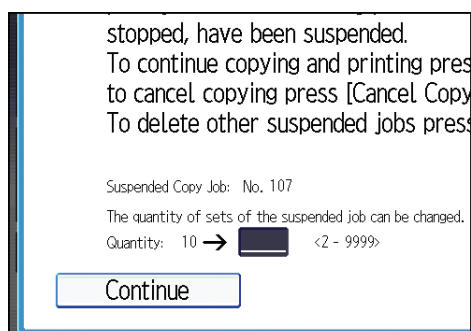

3. Press [Continue].

Copying starts again.

Storing Data in the Document Server

The Document Server enables you to store documents being read with the copy feature on the hard disk of this machine. Thus you can print them later applying necessary conditions.

You can check the stored documents on the Document Server screen. For details about the Document Server, see page 157 "Storing Data".

1. Press [Store File].

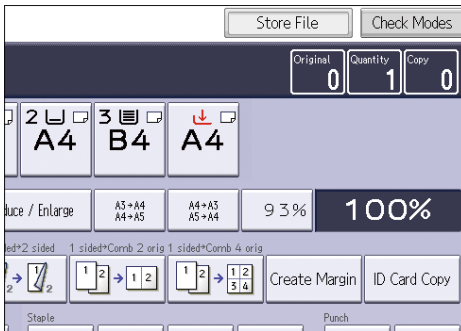

2. Enter a user name, file name, or password if necessary.
3. Specify a folder in which to store the document if necessary.
4. Press [OK].
5. Place the originals.
6. Make the scanning settings for the original.
7. Press the [Start] key.

Stores scanned originals in memory and makes one set of copies. If you want to store another document, do so after copying is complete.

4. Print

This chapter describes frequently used printer functions and operations. For information not included in this chapter, see [Print](#) available on our website.

Quick Install

You can install the printer drivers easily from the CD-ROM provided with this machine.

Using Quick Install, the PCL 6 printer driver is installed under network environment, and the Standard TCP/IP port will be set.

★ Important

- **Manage Printers permission is required to install the drivers. Log on as an Administrators group member.**

1. Click **[Quick Install]** on the installer screen.
2. The software license agreement appears in the **[License Agreement]** dialog box. After reading the agreement, click **[I accept the agreement.]**, and then click **[Next >]**.
3. Click **[Next >]**.
4. Select the machine model you want to use in the **[Select Printer]** dialog box.
5. Click **[Install]**.
6. When the port setting screen appears, specify a port.
7. Configure the user code, default printer, and shared printer as necessary.
8. Click **[Continue]**.

The installation starts.

9. Click **[Finish]**.

When you are prompted to restart your computer, restart it by following the instructions that appear.

10. Click **[Exit]** in the first window of the installer, and then take out the CD-ROM.

Displaying the Printer Driver Properties

This section explains how to open the printer driver properties from [Devices and Printers].

★ Important

- **Manage Printers permission is required to change the printer settings. Log on as an Administrators group member.**
- **You cannot change the machine default settings for individual users. Settings made in the printer properties dialog box are applied to all users.**

1. On the [Start] menu, click [Devices and Printers].
2. Right-click the icon of the printer you want to use.
3. Click [Printer properties].

Standard Printing

★ Important

- Duplex printing is selected as the default setting. If you want to print on only one side, select [Off] for the two-sided printing setting.
- If you send a print job via USB 2.0 while the machine is in Low Power mode or Sleep mode, an error message might appear when the print job is complete. In this case, check if the document was printed.

When Using the PCL 6 Printer Driver

1. Click the menu button of the application you are using, and then click [Print].
2. Select the printer you want to use.
3. Click [Preferences].
4. Select the [Frequently Used Settings] tab.
5. In the "Job Type:" list, select [Normal Print].
6. In the "Document Size:" list, select the size of the original to be printed.
7. In the "Orientation" area, select [Portrait] or [Landscape] as the orientation of the original.
8. In the "Input Tray:" list, select the paper tray that contains the paper you want to print onto.
If you select [Auto Tray Select] in the "Input Tray:" list, the paper tray is automatically selected according to the paper size and type specified.
9. In the "Paper Type:" list, select the type of paper that is loaded in the paper tray.
10. Select [Color] or [Black and White] in the "Color/Black and White:" list.
11. If you want to print multiple copies, specify a number of sets in the "Copies:" box.
12. Click [OK].
13. Start printing from the application's [Print] dialog box.

Printing on Both Sides of Sheets

This section explains how to print on both sides of each page using the printer driver.

★ Important

- The paper types that can be printed on both sides are as follows:
 - Plain, Recycled, Letterhead, Preprinted, Prepunched, Yellow, Green, Blue, Ivory, Orange, Pink, Red, Gray, Coated Paper: Gloss Print, Coated (Glossy), Coated (Matte), Metallic/Pearl, Synthetic, Textured

4

When Using the PCL 6 Printer Driver





1. Click the menu button of the application you are using, and then click [Print].
2. Select the printer you want to use.
3. Click [Preferences].
4. Click the [Frequently Used Settings] tab.

You can also click the [Detailed Settings] tab, and then click [2 Sided/Layout/Booklet] in the "Menu:" box.

5. Select the method for binding the output pages in the "2 sided:" list.
6. Change any other print settings if necessary.
7. Click [OK].
8. Start printing from the application's [Print] dialog box.

Types of Two-sided Printing

You can select which way the bound pages open by specifying which edge to bind.

Orientation	Open to Left	Open to Top
Portrait		
Landscape		

Combining Multiple Pages into Single Page

This section explains how to print multiple pages onto a single sheet. The combine printing function allows you to economize on paper by printing multiple sheets at reduced size onto a single sheet.

When Using the PCL 6 Printer Driver

1. Click the menu button of the application you are using, and then click [Print].
2. Select the printer you want to use.
3. Click [Preferences].
4. Click the [Frequently Used Settings] tab.

You can also click the [Detailed Settings] tab, and then click [2 Sided/Layout/Booklet] in the "Menu:" box.

5. Select the combination pattern in the "Layout:" list, and then specify the method for combining pages in the "Page Order:" list.

To draw a border line around each page, select the [Draw Frame Border] check box in [2 Sided/Layout/Booklet] in the [Detailed Settings] tab.

6. Change any other print settings if necessary.
7. Click [OK].
8. Start printing from the application's [Print] dialog box.

4

Types of Combine Printing

This function allows you to print 2, 4, 6, 9, or 16 pages at reduced size onto a single sheet and to specify a page ordering pattern for the combination. When combining 4 or more pages onto a single sheet of paper, four patterns are available.



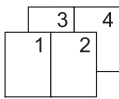
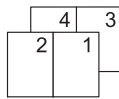

The following illustrations show example page ordering patterns for 2- and 4-page combinations.

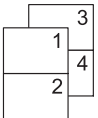
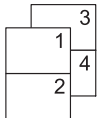
2 Pages per Sheet

Orientation	From Left to Right/Top to Bottom	From Right to Left/Top to Bottom
Portrait		

Orientation	From Left to Right/Top to Bottom	From Right to Left/Top to Bottom
Landscape		

4 Pages per Sheet

Right, then Down	Down, then Right	Left, then Down	Down, then Left
			

Printing on Envelopes

Configure the paper settings appropriately using both the printer driver and the control panel.

Configuring Envelope Settings Using the Control Panel

1. Load envelopes in the paper tray.

About how to load envelopes, see Paper Specifications and Adding Paper for details.

2. Display the paper settings screen.

- When using the standard operation panel

- Press the [Paper Setting] key.

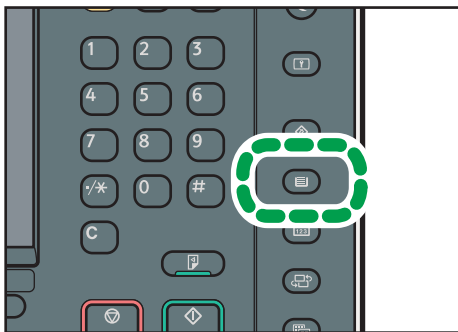

DRC135

- When using the Smart Operation Panel

- Press [Home] (🏠) at the bottom of the screen in the center.
- Press the [User Tools] icon (⚙️) on the [Home] screen
- Press [Tray Paper Settings].

3. Select the paper tray in which the envelopes are loaded.

4. Press [Manual Paper Settings].

5. Press [Envelope] in the "Paper Type" area, and then select the appropriate item in the "Paper Thickness" area.

6. Press the [Paper Size] tab.

7. Select the envelope size, and then press [OK].



8. Press [OK].

9. Close the paper settings screen.

- When using the standard operation panel

- Press the [Paper Setting] key.

- When using the Smart Operation Panel

1. Press [User Tools] () on the top right of the screen.
2. Press [Home] () at the bottom of the screen in the center.

Printing on Envelopes Using the Printer Driver

Note

- If you are printing on a registered custom paper, make the correct paper settings for the custom paper on the printer driver. For details about custom paper, see "Registering a Custom Paper", Paper Settings.

4

When using the PCL 6 printer driver

1. Click the menu button of the application you are using, and then click [Print].
2. Select the printer you want to use.
3. Click [Preferences].
4. In the "Document Size:" list, select the envelope size.
5. In the "Input Tray:" list, select the paper tray where the envelopes are loaded.
6. In the "Paper Type:" list, select [Envelope].
7. Change any other print settings if necessary.
8. Click [OK].
9. Start printing from the application's [Print] dialog box.

Saving and Printing Using the Document Server

The Document Server enables you to store documents on the machine's hard disk, and allows you to edit and print them as necessary.

★ Important

- Do not cancel the file transfer process while the data is being sent to the Document Server. The process may not be canceled properly. If you accidentally cancel a print job, use the control panel of the machine to delete the transferred data. For details about how to delete documents that are stored in the Document Server, see "Deleting Stored Documents", Copy/ Document Server, or Web Image Monitor Help.
- Up to 3,000 files can be stored in the Document Server. New files cannot be stored when 3,000 files have already been stored. Even if less than 3,000 files are stored, new files cannot be stored when
 - The number of pages in a document exceeds 3,000.
 - The total number of stored pages in the machine and the sent data has reached 15,000 (It may be fewer depending on the print data).
 - The hard disk is full.
- Data stored in the Document Server is specified to be deleted after three days (72 hours) by the factory default. We recommend you back up the data.

You can send data created on a client computer to the Document Server.

Storing Documents in Document Server

★ Important

- If the machine is not used as the Document Server, the maximum number of the documents that can be stored in the server may be less than the number described in the specification.
1. Click the menu button of the application you are using, and then click [Print].
 2. Select the printer you want to use.
 3. Click [Preferences].
 4. In the "Job Type:" list, click [Document Server].
 5. Click [Details...].
 6. Enter a user ID, file name, password, and user name as required.
 7. Specify the folder number to store the document in the "Folder Number" box.

When "0" is specified in the "Folder Number:" box, documents will be saved in the Shared folder.

8. If the folder is protected by a password, enter the password in the "Folder Password:" box.
9. Click [OK].
10. Change any other print settings if necessary.
11. Click [OK].
12. Start printing from the application's [Print] dialog box.

 **Note**

- You can print the documents stored in the Document Server using the control panel. For details, see "Printing Stored Documents", Copy/ Document Server.

4

Managing Documents Stored in Document Server

You can view or delete the documents stored in the machine's Document Server using Web Image Monitor from a client computer connected to the network.

Using the Quick Print Release Function (When Using the Smart Operation Panel)

The quick applications that are installed on this machine allow you to operate some of the printer functions from a single screen. Using the Quick Print Release function, you can view the list of documents that are stored on the machine. From the list, any documents can be selected and printed. The print settings of the document and the date and time to send the document can be changed as well.

1. Press [Home]  at the bottom of the screen in the center.
2. Press the [Quick Print Release] icon on the [Home] screen.
3. Select the user as required.
4. If necessary, enter the password for the documents.

The list of both the documents that have not password specified, and that matches the entered password is displayed.

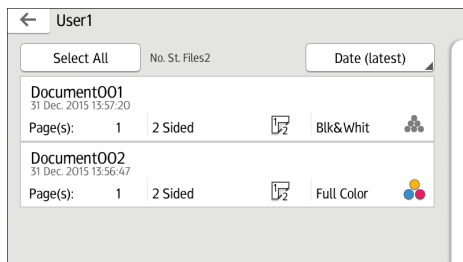

5. Select documents.

More than one document can be selected at one time.

You can perform the following operations on the selected documents:

- Delete
Deletes the selected documents.
- Preview
Shows the preview image of the first page of the document.
- Print Settings
Configures the print settings of the document.
- Manage Files
Specifies the date and time to send the document, and the password.
The file information cannot be modified when more than one document is selected.

6. Press [Print].

Using the Print/Scan (Memory Storage Device) Function (When Using the Smart Operation Panel)

⚠ CAUTION

- Keep SD cards or USB flash memory devices out of reach of children. If a child accidentally swallows an SD card or USB flash memory device, consult a doctor immediately.

The Print/Scan (Memory Storage Device) function allows you to read and print files that are stored on a memory storage device such as an SD card or USB flash memory device. Also, you can save the scanned data on a memory storage device.

The files in the following formats can be printed using the Print/Scan (Memory Storage Device) function: JPEG, TIFF, PDF, and XPS. The scanned data can be saved in JPEG, TIFF, or PDF format.

Printing a file in a memory storage device

1. Press [Home] (🏠) at the bottom of the screen in the center.
2. Press the [Print/Scan (Memory Storage Device)] icon on the [Home] screen.
3. Press [Print from Storage Device].
4. Insert a memory storage device in the media slot.
For details about how to insert a memory storage device, see "Inserting/Removing a Memory Storage Device", Getting Started.
5. Press [USB] or [SD Card], depending on the type of the storage device.
6. Select the document to print.

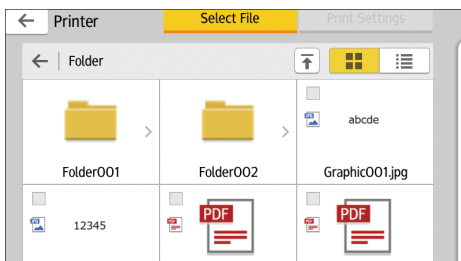

You can perform the following operations on the selected document:

- Preview
Shows the preview image of the first page of the document.
- Selected
Displays the list of the selected documents.

7. If necessary, press [Print Settings] to change the settings such as the number of copies or duplex printing.
8. Press [Start].

Saving the scanned data in a memory storage device

1. Press [Home]  at the bottom of the screen in the center.
2. Press the [Print/Scan (Memory Storage Device)] icon on the [Home] screen.
3. Press [Scan to Storage Device].
4. Insert a memory storage device in the media slot.

For details about how to insert a memory storage device, see "Inserting/Removing a Memory Storage Device", Getting Started.

5. Press [USB] or [SD Card], depending on the type of the storage device that you are using.
6. Specify the location to save the scanned data.

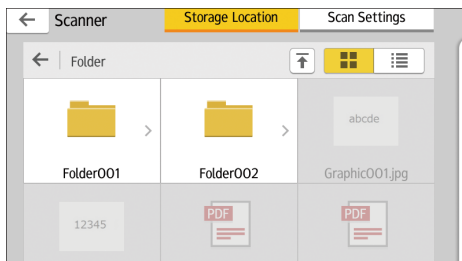

7. Place the original.
8. If necessary, press [Scan Settings] to change the settings such as the file type or scan resolution.
9. To see the scanned image before saving it to a file, press [Preview].
10. Press [Start].
11. When the confirmation screen appears, press [Finish Scan] after scanning of the original has been completed.
If there are more originals to be scanned, place the next original, and then press [Scan Next Original].
12. When the preview screen appears, check the scanned image, and then press [Save].

Note

- If the file name is not specified in [Scan Settings], the scanned image is saved under the name that conforms to the following naming rules:
 - For single page format:

Transmission date and time (YYYYMMDDHHMMSSMMM) + 4 digit serial page number (_nnnn) + extension (.tif/.jpg/.pdf)

For example, when you send 10-page original in jpeg format at 15:30:15.5 on Dec. 31, 2020, the file names are from "20201231153015500_0001.jpg" to "20201231153015500_0010.jpg".

- For multi page format:

Transmission date and time (YYYYMMDDHHMMSSMMM) + extension (.tif/.jpg/.pdf)

For example, when you send 10-page original in PDF format at 15:30:15.5 on Dec. 31, 2020, the file name is "20201231153015500.pdf".

- When you save scanned data to a memory storage device, use characters which correspond to the ASCII codes for the file name. If you use characters which is not correspond to the ASCII codes, the machine may not read or save the documents.
- Certain types of USB flash memory device and SD cards cannot be used.

5. Scan

This chapter describes frequently used scanner functions and operations. For information not included in this chapter, see Scan available on our website.

Basic Procedure When Using Scan to Folder

★ Important

- Before performing this procedure, see "Preparation for Sending by Scan to Folder", Scan, and confirm the details of the destination computer. See also "Registering Folders", Connecting the Machine/ System Settings, and register the address of the destination computer to the address book.

When using the standard operation panel

For details about how to use this function, see page 133 "Basic Procedure When Using Scan to Folder (Classic)".

When using the Smart Operation Panel

You can use this function from the Scanner Application and Scanner (Classic) Application.

📄 When Using the Scanner Application

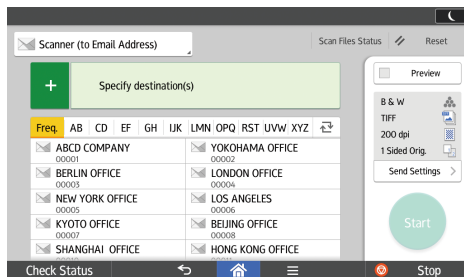

About how to use the application's screen, see page 67 "[Scanner] Screen (When Using the Smart Operation Panel)".

📄 When Using the Scanner (Classic) Application

For details about how to use the Classic Scanner function, see page 133 "Basic Procedure When Using Scan to Folder (Classic)".

Basic Procedure When Using Scan to Folder (Classic)

1. Display the initial scanner screen.

- When using the standard operation panel
 1. Press the [Home] key on the control panel.

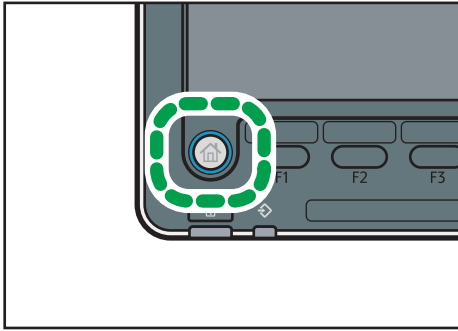

CUV108

2. Press the [Scanner] icon on the screen.

If the [Scanner] icon does not appear, press the  icon at the upper right corner of the screen to switch to the menu screen.

- When using the Smart Operation Panel
 1. Press [Home] () at the bottom of the screen in the center.
 2. Press the [Scanner (Classic)] icon on the [Home] screen.

2. Make sure that no previous settings remain.

If a previous setting remains, press the [Reset] key.

3. Press the [Folder] tab.

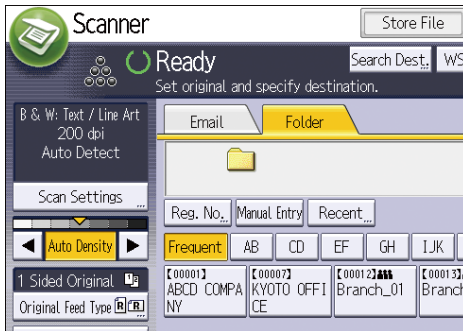

4. Place originals.

5. If necessary, specify the scan settings according to the original to be scanned.

Example: Scanning the document in color/duplex mode, and saving as a PDF file.

- Press [Scan Settings], press [Full Color: Text / Photo] in the [Original Type] tab, and then press [OK].
- Press [Original Feed Type], press [2 Sided Original], and then press [OK].
- Press [Send File Type / Name], press [PDF], and then press [OK].

For information about other settings, see the each section.

6. Specify the destination.

You can specify multiple destinations. For details, see "Specifying Scan to Folder Destinations", Scan.

7. Press the [Start] key.

Creating a Shared Folder on a Computer Running Windows/Confirming a Computer's Information

The following procedures explain how to create a shared folder on a computer running Windows, and how to confirm the computer's information. In these examples, Windows 7 is the operating system, and the computer is a member in a network domain. Write down the confirmed information.

Step 1: Confirming the user name and computer name

Confirm the user name and the name of the computer you will send scanned documents to.

1. On the [Start] menu, point to [All Programs], click [Accessories], and then click [Command Prompt].
2. Enter the command "ipconfig/all", and then press the [Enter] key.
3. Confirm the name of the computer.

The computer's name is displayed under [Host Name].

You can also confirm the IPv4 address. The address displayed under [IPv4 Address] is the IPv4 address of the computer.

4. Enter the command "set user", and then press the [Enter] key.

Be sure to put a space between "set" and "user".

5. Confirm the user name.

The user name is displayed under [USERNAME].

Step 2: Creating a shared folder on a computer running Microsoft Windows

Create a shared destination folder in Windows and enable sharing. In the following procedure, a computer which is running under Windows 7 and participating in a domain is used as an example.

★ Important

- You must log in as an Administrators group member to create a shared folder.
- If "Everyone" is left selected in Step 6, the created shared folder will be accessible by all users. This is a security risk, so we recommend that you give access rights only to specific users. Use the following procedure to remove "Everyone" and specify user access rights.

1. Create a folder, just as you would create a normal folder, in a location of your choice on the computer.
2. Right-click the folder, and then click [Properties].
3. On the [Sharing] tab, click [Advanced Sharing...].
4. Select the [Share this folder] check box.
5. Click [Permissions].
6. In the [Group or user names:] list, select "Everyone", and then click [Remove].
7. Click [Add...].
8. In the [Select Users, Computers, Service Accounts, or Groups] window, click [Advanced...].
9. Specify one or more object types, select a location, and then click [Find Now].
10. From the list of results, select the groups and users you want to grant access to, and then click [OK].
11. In the [Select Users, Computers, Service Accounts, or Groups] window, click [OK].
12. In the [Group or user names:] list, select a group or user, and then, in the [Allow] column of the permissions list, select either the [Full Control] or [Change] check box.
Configure the access permissions for each group and user.
13. Click [OK].

Step 3: Specifying access privileges for the created shared folder

If you want to specify access privileges for the created folder to allow other users or groups to access the folder, configure the folder as follows:

1. Right-click the folder created in Step 2, and then click [Properties].
2. On the [Security] tab, click [Edit...].
3. Click [Add...].
4. In the [Select Users, Computers, Service Accounts, or Groups] window, click [Advanced...].
5. Specify one or more object types, select a location, and then click [Find Now].
6. From the list of results, select the groups and users you want to grant access to, and then click [OK].
7. In the [Select Users, Computers, Service Accounts, or Groups] window, click [OK].
8. In the [Groups or user names:] list, select a group or user, and then, in the [Allow] column of the permissions list, select either the [Full Control] or [Modify] check box.
9. Click [OK].

Registering an SMB Folder

1. Display the [Address Book Management] screen.

- When using the standard operation panel
 1. Press the [Home] key on the lower left of the control panel.
 2. Press the [Address Book Management] icon on the [Home] screen.
- When using the Smart Operation Panel
 1. Press [Home] (🏠) at the bottom of the screen in the center.
 2. Press the [Address Book Management] icon on the [Home] screen.

2. Check that [Program / Change] is selected.

3. Press [New Program].

4. Press [Change] under "Name".

The name entry display appears.

5. Enter the name, and then press [OK].

6. Press [▼Next].

7. Press the key for the classification you want to use under "Select Title".

	Names	Auth. Info	Protection
▶ Select Title			
Title 1	Frequent	AB	CD EF GH IJK
Title 2	Frequent	1	2 3 4 5
Title 3	Frequent	1	2

The keys you can select are as follows:

- [Frequent]: Added to the page that is displayed first.
- [AB], [CD], [EF], [GH], [IJK], [LMN], [OPQ], [RST], [UVW], [XYZ], [1] to [10]: Added to the list of items in the selected title.

You can select [Frequent] and one more key for each title.

8. Press [Auth. Info], and then press [▼Next].

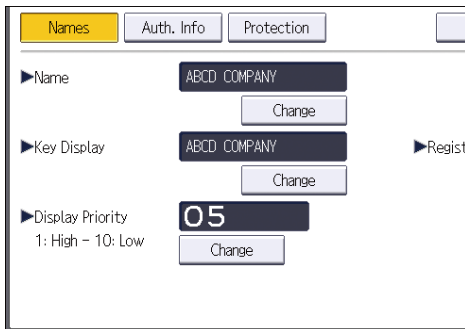

9. Press [Specify Other Auth. Info] on the right side of "Folder Authentication".

When [Do not Specify] is selected, the SMB User Name and SMB Password that you have specified in "Default User Name / Password (Send)" of File Transfer settings are applied.

5

10. Press [Change] under "Login User Name".

11. Enter the login user name of the destination computer, and then press [OK].

12. Press [Change] under "Login Password".

13. Enter the password of the destination computer, and then press [OK].

14. Enter the password again to confirm, and then press [OK].

15. Press [Folder].

16. Check that [SMB] is selected.

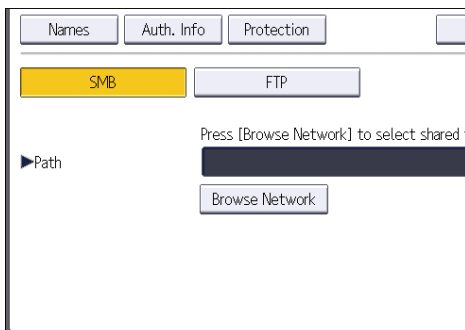

17. Press [Change] or [Browse Network], and then specify the folder.

To specify a folder, you can either enter the path manually or locate the folder by browsing the network.

For details about how to specify the path manually, see page 139 "Locating the SMB folder manually".

For details about how to specify the path using Browse Network, see page 139 "Locating the SMB folder using Browse Network".

18. Press [Connection Test] to check the path is set correctly.

19. Press [Exit].

If the connection test fails, check the settings, and then try again.

20. Press [OK].**21. Close the [Address Book Management] screen.**

- When using the standard operation panel
 1. Press the [User Tools] key.
- When using the Smart Operation Panel
 1. Press [User Tools] (⚙️) on the top right of the screen.
 2. Press [Home] (🏠) at the bottom of the screen in the center.

Locating the SMB folder manually

1. Press [Change] under "Path".**2. Enter the path where the folder is located.**

For example: if the name of the destination computer is "User", and the folder name is "Share", the path will be \\User\Share.

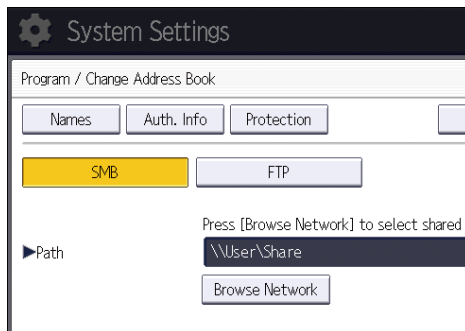

If the network does not allow automatic obtaining of IP addresses, include the destination computer's IP address in the path. For example: if the IP address of the destination computer is "192.168.0.191", and the folder name is "Share", the path will be \\192.168.0.191\Share.

3. Press [OK].

If the format of the entered path is not correct, a message appears. Press [Exit], and then enter the path again.

Locating the SMB folder using Browse Network

1. Press [Browse Network].

The client computers sharing the same network as the machine appear.

Network display only lists client computers you are authorized to access.

2. **Select the group that contains the destination computer.**
3. **Select the computer name of the destination computer.**

Shared folders under it appear.

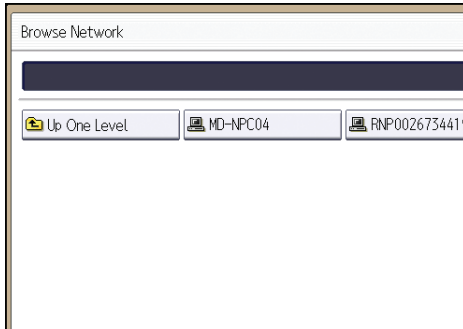

5

You can press [Up One Level] to switch between levels.

4. **Select the folder you want to register.**
5. **Press [OK].**

Deleting an SMB Registered Folder

1. **Display the [Address Book Management] screen.**
 - When using the standard operation panel
 1. Press the [Home] key on the lower left of the control panel.
 2. Press the [Address Book Management] icon on the [Home] screen.
 - When using the Smart Operation Panel
 1. Press [Home] (🏠) at the bottom of the screen in the center.
 2. Press the [Address Book Management] icon on the [Home] screen.

2. **Check that [Program / Change] is selected.**

3. **Select the name whose folder you want to delete.**

Press the name key, or enter the registered number using the number keys.

You can search by the registered name, user code, folder name, or e-mail address.

4. **Press [Folder].**
5. **Press the protocol which is not currently selected.**

A confirmation message appears.

6. **Press [Yes].**
7. **Press [OK].**

8. Close the [Address Book Management] screen.

- When using the standard operation panel
 1. Press the [User Tools] key.
- When using the Smart Operation Panel
 1. Press [User Tools] (⚙️) on the top right of the screen.
 2. Press [Home] (🏠) at the bottom of the screen in the center.

Entering the Path to the Destination Manually

When using the standard operation panel

For details about how to use this function, see page 142 "Procedure for entering the path to the destination manually (classic)".

When using the Smart Operation Panel

You can use this function from the Scanner Application and Scanner (Classic) Application.

📄 When Using the Scanner Application

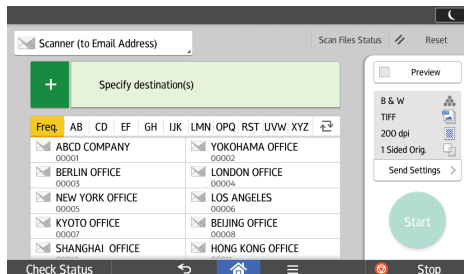

About how to use the application's screen, see page 67 "[Scanner] Screen (When Using the Smart Operation Panel)".

📄 When Using the Scanner (Classic) Application

For details about how to use the Classic Scanner function, see page 142 "Procedure for entering the path to the destination manually (classic)".

Procedure for entering the path to the destination manually (classic)

1. Press [Manual Entry].

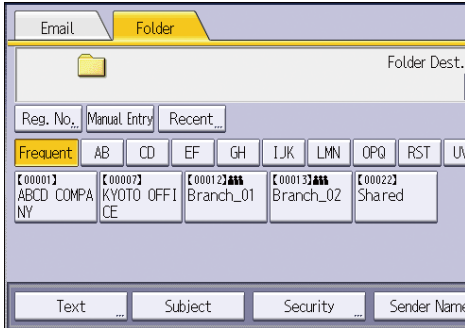

2. Make sure that [SMB] is selected.

3. Press [Manual Entry] on the right side of the path field.

4. Enter the path for the folder.

In the following example path, the shared folder name is "user" and the computer name is "desk01":

```
\\desk01\user
```

5. Press [OK].

6. Depending on the destination setting, enter the user name for logging in to the computer.

Press [Manual Entry] to the right of the user name field to display the soft keyboard.

7. Press [OK].

8. Depending on the destination setting, enter the password for logging in to the computer.

Press [Manual Entry] for the password to display the soft keyboard.

9. Press [OK].

10. Press [Connection Test].

A connection test is performed to check whether the specified shared folder exists.

If the message "Connection with PC has failed. Check the settings." appears, see "Troubleshooting When You Use the Scanner Function", Troubleshooting.

11. Check the connection test result, and then press [Exit].

12. Press [OK].

Basic Procedure for Sending Scan Files by E-mail

When using the standard operation panel

For details about how to use this function, see page 143 "Basic Procedure for Sending Scan Files by E-mail (Classic)".

When using the Smart Operation Panel

You can use this function from the Scanner Application and Scanner (Classic) Application.

When Using the Scanner Application

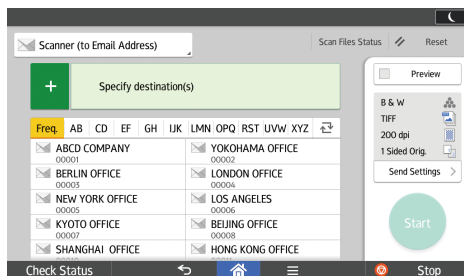

About how to use the application's screen, see page 67 "[Scanner] Screen (When Using the Smart Operation Panel)".

When Using the Scanner (Classic) Application

For details about how to use the Classic Scanner function, see page 143 "Basic Procedure for Sending Scan Files by E-mail (Classic)".

Basic Procedure for Sending Scan Files by E-mail (Classic)

1. Display the initial scanner screen.

- When using the standard operation panel
 1. Press the [Home] key on the control panel.

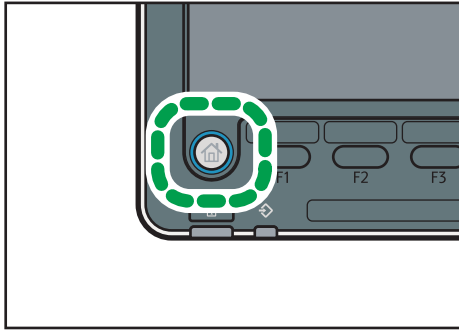

CUV108

2. Press the [Scanner] icon on the screen.

If the [Scanner] icon does not appear, press the  icon at the upper right corner of the screen to switch to the menu screen.

- When using the Smart Operation Panel
 1. Press [Home] () at the bottom of the screen in the center.
 2. Press the [Scanner (Classic)] icon on the [Home] screen.

2. Make sure that no previous settings remain.

If a previous setting remains, press the [Reset] key.

3. Make sure that the [Email] tab is selected.

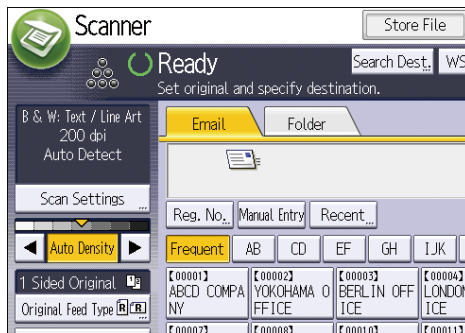

4. Place originals.

5. If necessary, specify the scan settings according to the original to be scanned.

Example: Scanning the document in color/duplex mode, and saving as a PDF file.

- Press [Scan Settings], press [Full Color: Text / Photo] in the [Original Type] tab, and then press [OK].
- Press [Original Feed Type], press [2 Sided Original], and then press [OK].
- Press [Send File Type / Name], press [PDF], and then press [OK].

For information about other settings, see the each section.

The settings explained in "Entering the E-mail Subject", "Entering the E-mail Message", and "Security Settings to E-mails", Scan, can also be specified.

6. Specify the destination.

You can specify multiple destinations. For details, see "Specifying the Destination or Recipient", Scan.

7. Press [Sender Name], select the e-mail sender, and then press [OK].

For details, see "Specifying the E-mail Sender", Scan.

8. To use Message Disposition Notification, press [Recept. Notice].

If you press [Recept. Notice], the selected e-mail sender will receive e-mail notification when the e-mail recipient has opened the e-mail.

9. Press the [Start] key.

Registering an E-mail Destination

5

1. Display the [Address Book Management] screen.

- When using the standard operation panel
 1. Press the [Home] key on the lower left of the control panel.
 1. Press the [Address Book Management] icon on the [Home] screen.
- When using the Smart Operation Panel
 1. Press [Home] () at the bottom of the screen in the center.
 1. Press the [Address Book Management] icon on the [Home] screen.

2. Check that [Program / Change] is selected.

3. Press [New Program].

4. Press [Change] under "Name".

The name entry display appears.

5. Enter the name, and then press [OK].

6. Press [▼Next].

7. Press the key for the classification you want to use under "Select Title".

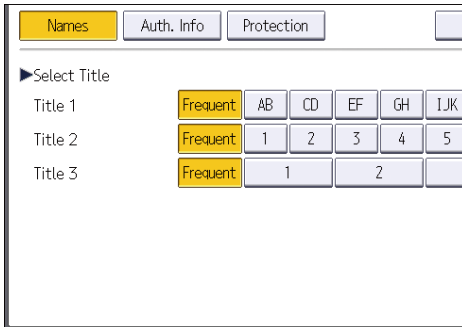

The keys you can select are as follows:

- [Frequent]: Added to the page that is displayed first.
- [AB], [CD], [EF], [GH], [IJK], [LMN], [OPQ], [RST], [UVW], [XYZ], [1] to [10]: Added to the list of items in the selected title.

You can select [Frequent] and one more key for each title.

8. Press [Email].

9. Press [Change] under "Email Address".

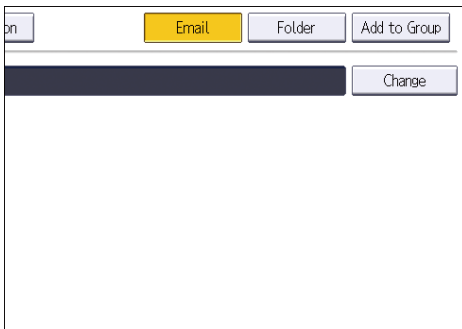



10. Enter the e-mail address, and then press [OK].



11. If you want to use Internet fax, specify whether or not to use "Send via SMTP Server".

12. Press [OK].

13. Close the [Address Book Management] screen.

- When using the standard operation panel
 1. Press the [User Tools] key.
- When using the Smart Operation Panel
 1. Press [User Tools] () on the top right of the screen.
 2. Press [Home] () at the bottom of the screen in the center.



Deleting an E-mail Destination**1. Display the [Address Book Management] screen.**

- When using the standard operation panel
 1. Press the [Home] key on the lower left of the control panel.
 2. Press the [Address Book Management] icon on the [Home] screen.
- When using the Smart Operation Panel
 1. Press [Home] () at the bottom of the screen in the center.
 2. Press the [Address Book Management] icon on the [Home] screen.

2. Check that [Program / Change] is selected.**3. Select the name whose e-mail address you want to delete.**

Press the name key, or enter the registered number using the number keys. You can search by the registered name, user code, folder name, or e-mail address.

4. Press [Email].**5. Press [Change] under "Email Address".****6. Press [Delete All], and then press [OK].****7. Press [OK].****8. Close the [Address Book Management] screen.**

- When using the standard operation panel
 1. Press the [User Tools] key.
- When using the Smart Operation Panel
 1. Press [User Tools] () on the top right of the screen.
 2. Press [Home] () at the bottom of the screen in the center.

Entering an E-mail Address Manually

When using the standard operation panel

For details about how to use this function, see page 148 "Procedure for entering an e-mail address manually (classic)".

When using the Smart Operation Panel

You can use this function from the Scanner Application and Scanner (Classic) Application.

When Using the Scanner Application

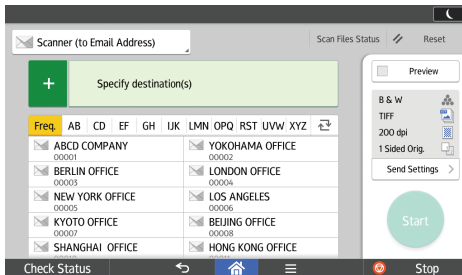

About how to use the application's screen, see page 67 "[Scanner] Screen (When Using the Smart Operation Panel)".

When Using the Scanner (Classic) Application

For details about how to use the Classic Scanner function, see page 148 "Procedure for entering an e-mail address manually (classic)".

Procedure for entering an e-mail address manually (classic)

1. Press [Manual Entry].

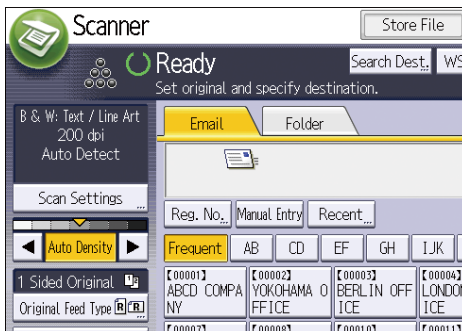

2. Enter the e-mail address.

3. Press [OK].

Basic Procedure for Storing Scan File

★ Important

- You can specify a password for each stored file. We recommend that you protect stored files from unauthorized access by specifying passwords.
- Scan file stored in the machine may be lost if some kind of failure occurs. We advise against using the hard disk to store important files. The supplier shall not be responsible for any damage that may result from the loss of files.

1. Display the initial scanner screen.

- When using the standard operation panel
 1. Press the [Home] key on the control panel.

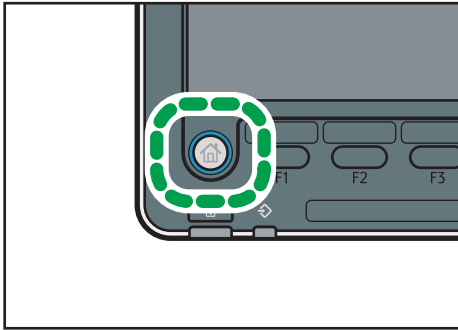

CUV108

2. Press the [Scanner] icon on the screen.

If the [Scanner] icon does not appear, press the  icon at the upper right corner of the screen to switch to the menu screen.

- When using the Smart Operation Panel
 1. Press [Home] () at the bottom of the screen in the center.
 2. Press the [Scanner (Classic)] icon on the [Home] screen.

2. Make sure that no previous settings remain.

If a previous setting remains, press the [Reset] key.

3. Place originals.

4. Press [Store File].

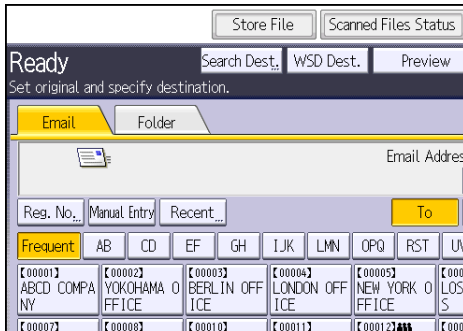

5. Press [Store to HDD].

6. If necessary, specify the stored file's information, such as [User Name], [File Name], [Password], and [Select Folder].

- User Name
Press [User Name], and then select a user name. To specify an unregistered user name, press [Manual Entry], and then enter the name. After specifying a user name, press [OK].
- File Name
Press [File Name], enter a file name, and then press [OK].
- Password
Press [Password], enter a password, and then press [OK]. Re-enter the password for confirmation, and then press [OK].
- Select Folder
Press [Select Folder], specify the folder in which to save the stored files, and then press [OK].

7. Press [OK].

8. If necessary, press [Scan Settings] to specify scanner settings such as resolution and scan size.

For details, see "Scan Settings", Scan.

9. Press the [Start] key.

Checking a Stored File Selected from the List

This section explains how to preview a file selected from the list of stored files.

1. Press [Select Stored File].

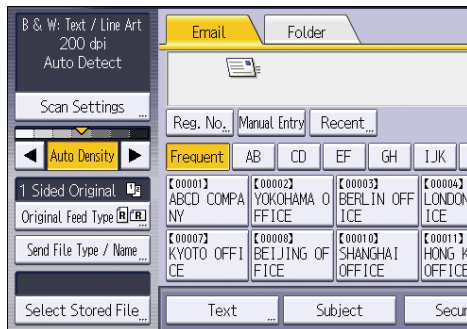

2. Specify the folder in which the file you want to check is stored.

3. From the list of stored files, select the file you want to check.

You can select more than one file.

For details about searching the stored document by user or document name, see "Searching by user name" and "Searching by file name", Scan.

4. Press [Preview].

Specifying the File Type

This section explains the procedure for specifying the file type of a file you want to send.

File types can be specified when sending files by e-mail or Scan to Folder, sending stored files by e-mail or Scan to Folder, and saving files on a memory storage device.

You can select one of the following file types:

- Single Page: [TIFF / JPEG], [PDF]

If you select a single-page file type when scanning multiple originals, one file is created for each single page and the number of files sent is the same as the number of pages scanned.

- Multi-page: [TIFF], [PDF]

If you select a multi-page file type when scan multiple originals, scanned pages are combined and sent as a single file.

5

Selectable file types differ depending on the scan settings and other conditions. For details about file types, see "Notes about and limitations of file types", Scan.

When using the standard operation panel

For details about how to use this function, see page 153 "Procedure for Specifying the File Type (Classic)".

When using the Smart Operation Panel

You can use this function from the Scanner Application and Scanner (Classic) Application.

When Using the Scanner Application

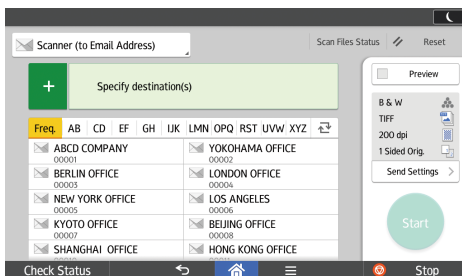

About how to use the application's screen, see page 67 "[Scanner] Screen (When Using the Smart Operation Panel)".

When Using the Scanner (Classic) Application

For details about how to use the Classic Scanner function, see page 153 "Procedure for Specifying the File Type (Classic)".

Procedure for Specifying the File Type (Classic)

1. Press [Send File Type / Name].

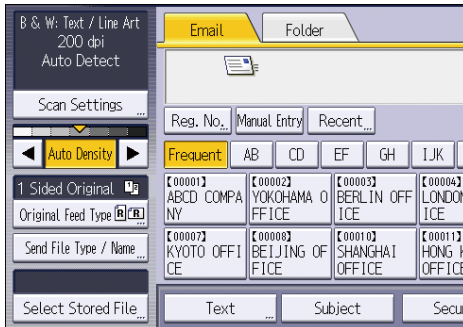

2. Select a file type.

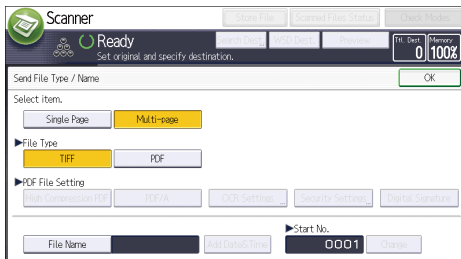

If the File Type is set to [PDF], configure PDF File Setting as required.

3. Press [OK].

Specifying Scan Settings

When using the standard operation panel

For details about how to use this function, see page 154 "Procedure for Specifying Scan Settings (Classic)".

When using the Smart Operation Panel

You can use this function from the Scanner Application and Scanner (Classic) Application.

When Using the Scanner Application

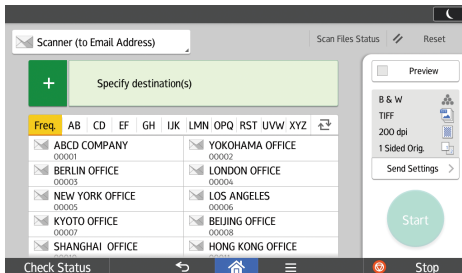

About how to use the application's screen, see page 67 "[Scanner] Screen (When Using the Smart Operation Panel)".

When Using the Scanner (Classic) Application

For details about how to use the Classic Scanner function, see page 154 "Procedure for Specifying Scan Settings (Classic)".

Procedure for Specifying Scan Settings (Classic)

1. Press [Scan Settings].

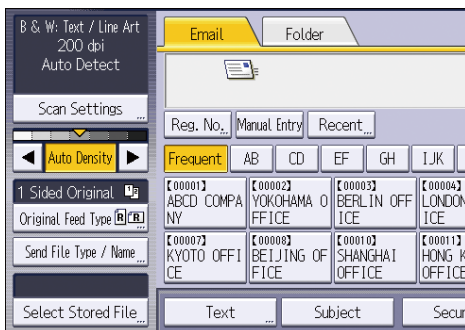

2. Specify resolution, scan size, and other settings, as required.

For details about individual scan setting items, see "Scan Settings", Scan.

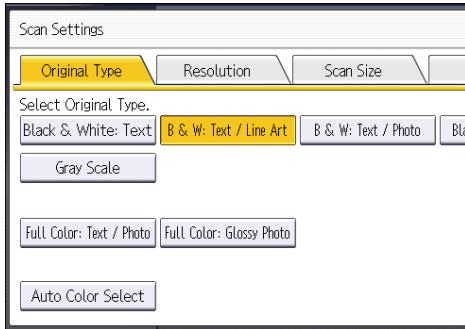

3. Press [OK].

6. Document Server

This chapter describes frequently used Document Server functions and operations. For information not included in this chapter, see Copy/ Document Server available on our website.

Storing Data

This section describes the procedure for storing documents on the Document Server.

★ Important

- A document accessed with a correct password remains selected even after operations are complete, and it can be accessed by other users. After the operation, be sure to press the [Reset] key to cancel the document selection.
- The user name registered to a stored document in the Document Server is to identify the document creator and type. It is not to protect confidential documents from others.
- When scanning by the scanner, make sure that all other operations are ended.
- You cannot use [3 Edges Full Bleed] to store documents with the document server function. Use the copier function to store documents if you want to use [3 Edges Full Bleed] to store documents.

File Name

A file name such as "COPY0001" and "COPY0002" is automatically attached to the scanned document. You can change the file name.

User Name

You can register a user name to identify the user or user group that stored the documents. To assign it, select the user name registered in the Address Book, or enter the name directly. Depending on the security setting, [Access Privileges] may appear instead of [User Name].

For details about the Address Book, see "Registering Addresses and Users", Connecting the Machine/ System Settings.

Password

To prevent unauthorized printing, you can specify a password for any stored document. A protected document can only be accessed if its password is entered. If a password is specified for the documents, the lock icon appears on the left side of the file name.

1. Display the initial Document Server screen.

- When using the standard operation panel
 1. Press the [Home] key on the control panel.

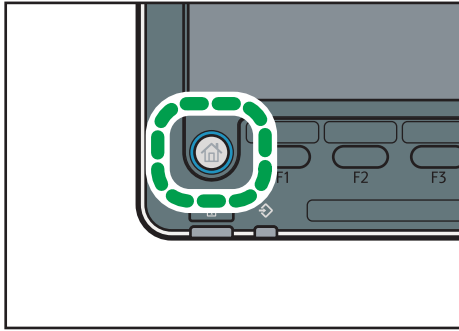

2. Press the [Document Server] icon on the screen.

If the [Document Server] icon does not appear, press the  icon at the upper right corner of the screen to switch to the menu screen.

- When using the Smart Operation Panel
 1. Press [Home] () at the bottom of the screen in the center.
 2. Press the [Document Server] icon on the [Home] screen.

6

2. Press [To Scanning Screen].
3. Press [Target Fldr. to Store].
4. Specify a folder in which to store the document, and then press [OK].
5. Press [User Name].
6. Specify a user name, and then press [OK].

The user names shown are names that were registered in the Address Book. To specify a name not shown in the screen, press [Manual Entry], and then enter a user name.

7. Press [File Name].
8. Enter a file name, and then press [OK].
9. Press [Password].
10. Enter a password with the number keys, and then press [OK].
11. For double-check, enter the password again, and then press [OK].
12. Place the original.
13. Specify the original scanning conditions.
14. Press the [Start] key.

The original is scanned. The document is saved in the Document Server.

After scanning, a list of folders will be displayed. If the list does not appear, press [Finish Scanning].

Printing Stored Documents

Prints stored documents on the Document Server.

The items you can specify on the printing screen are as follows:

- Paper tray
- The number of prints
- [Finishing] ([Output], [Finisher], [Folding Unit])
- [Cover/Slip Sheet] ([Front Cover], [Back Cover], [Designate/Chapter], [Slip Sheet])
- [Edit / Stamp] ([Margin Adj.], [Stamp], [Edit Image])
- [2 Sided / Book] ([1 Sided Print], [2 Sided Top to Top], [2 Sided Top to Bottom], [Specify Duplex Pages], [Booklet], [Magazine])

For details about each function, see the each section.

1. Select a folder.

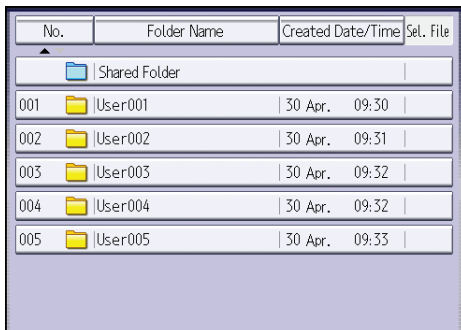

No.	Folder Name	Created Date/Time	Sel. file
	Shared Folder		
001	User001	30 Apr. 09:30	
002	User002	30 Apr. 09:31	
003	User003	30 Apr. 09:32	
004	User004	30 Apr. 09:32	
005	User005	30 Apr. 09:33	

2. Select a document to be printed.

3. When printing two or more documents at a time, repeat Step 2.

Up to 30 documents can be printed.

4. When specifying printing conditions, press [To Printing Screen], and then configure print settings.

5. Enter the number of print copies with the number keys.

The maximum quantity that can be entered is 9999.

6. Press the [Start] key.

7. Web Image Monitor

This chapter describes frequently used Web Image Monitor functions and operations. For information not included in this chapter, see Connecting the Machine/ System Settings available on our website or Web Image Monitor Help.

Displaying Top Page

This section explains the Top Page and how to display Web Image Monitor.

★ Important

- When entering an IPv4 address, do not begin segments with zeros. For example: If the address is "192.168.001.010", you must enter it as "192.168.1.10".

1. Start your web browser.
2. Enter "http://(machine's IP address or host name)/" in your web browser's URL bar.

Top Page of Web Image Monitor appears.

If the machine's host name has been registered on the DNS or WINS server, you can enter it.

When setting SSL, a protocol for encrypted communication, under environment which server authentication is issued, enter "https://(machine's IP address or host name)/".

Web Image Monitor is divided into the following areas:

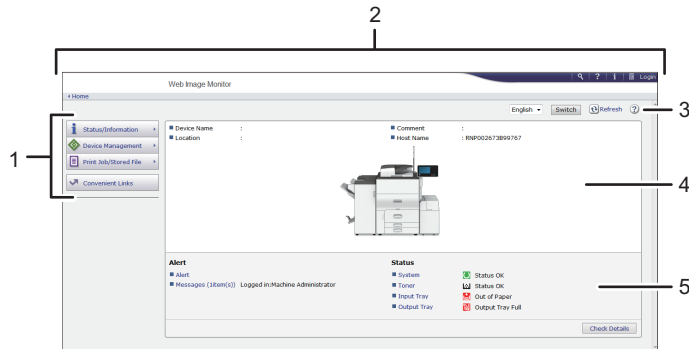

DRC715

1. Menu area

If you select a menu item, its content will be shown.

2. Header area

Display icons for the links to Help and the keyword search function. This area also displays [Login] and [Logout], which allows you to switch between the administrator and guest mode.

3. Refresh/Help

(Refresh): Click at the upper right in the work area to update the machine information. Click the web browser's [Refresh] button to refresh the entire browser screen.

 (Help): Use Help to view or download Help file contents.

4. Basic Information area

Display the basic information of the machine.

5. Work area

Display the contents of the item selected in the menu area.

8. Adding Paper and Toner

This chapter describes how to load paper into the paper tray and recommended paper sizes and types.

Loading Paper

Precautions for Loading Paper

CAUTION

- When loading paper, take care not to trap or injure your fingers.

Important

- Do not stack paper over the limit mark.

Note

- To prevent multiple sheets from being fed at once, fan the paper before loading it.
- If you load paper when only a few sheets of paper remain in the tray, multiple sheet feeding may occur. Remove any remaining paper, stack them with the new sheets of paper, and then fan the entire stack before loading it into the tray.
- Straighten curled or warped paper before loading.
- When you load paper into the paper tray for the first time or when you change the size or type of paper in the paper tray, be sure to specify the appropriate paper settings in Tray Paper Settings. For details, see "Changing Tray Paper Settings", Paper Settings.
- For details about the paper sizes and types that can be used, see page 189 "Recommended Paper Sizes and Types".
- You might at times hear a rustling noise from paper moving through the machine. This noise does not indicate a malfunction.

Fanning the paper

Important

- If you load coated paper, label paper, transparencies, or thick paper of 150.1–360.0 g/m² (55.1 lb. Cover–198.0 lb. Index), it is important that you fan the sheets thoroughly. Misfeeds may occur if paper is not fanned thoroughly. If the machine feeds several sheets of paper together or it does not feed paper, fan paper and load it again.

1. Loosen the stack by riffling the sheets.

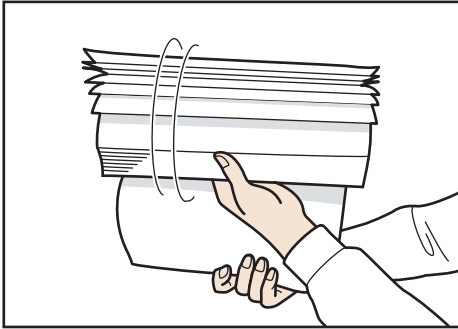

CVA068

2. Holding its shorter ends, flex the stack back and forth to create space between the sheets. Repeat this several times.

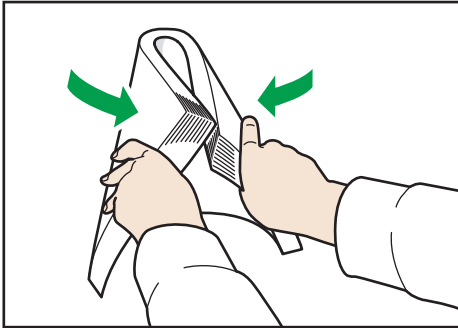

CVA069

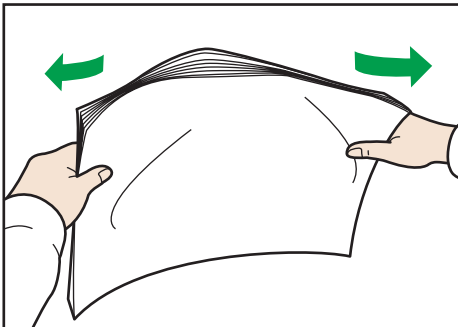

CVA070

3. Make sure there is space between the sheets.

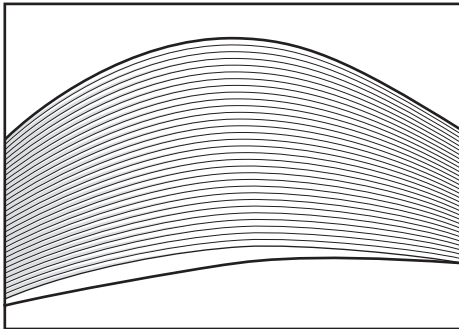

CVA071

4. Hold the stack of paper in both hands and tap the long and short edges of the paper against a flat surface to align them.

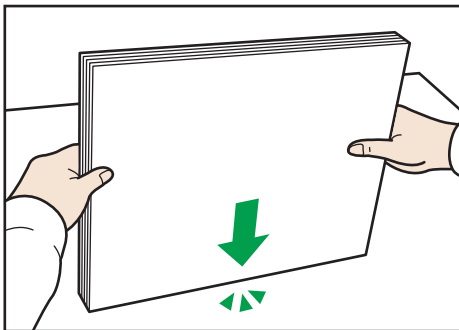

DRC153

Loading Paper into Tray 1

Region A (mainly Europe)

Tray 1 can hold A4 paper only. If you want to print on $8\frac{1}{2} \times 11$ from Tray 1, contact your service representative.

Region B (mainly North America)

Tray 1 can hold $8\frac{1}{2} \times 11$ paper only. If you want to print on A4 from Tray 1, contact your service representative.

★ Important

- When paper loaded in the right side of Tray 1 runs out, paper on the left is automatically shifted to the right. Do not pull out Tray 1 while the tray is moving paper; wait until sounds stop coming from the tray.

1. Carefully pull out the paper tray until it stops.

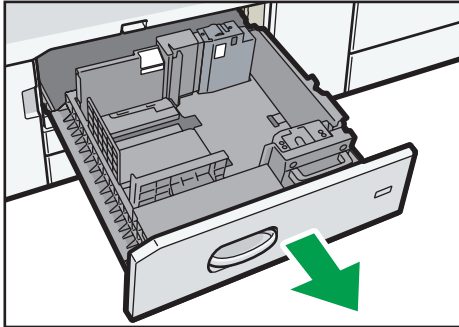

DRC155

2. Square the paper and load it print side down.

When you load paper into the right side of the tray, load the paper so its right edge is flush against the right side of the tray.

When you load paper into the left side of the tray, load the paper so its left edge is flush against the left side of the tray.

- Whole tray pulled out

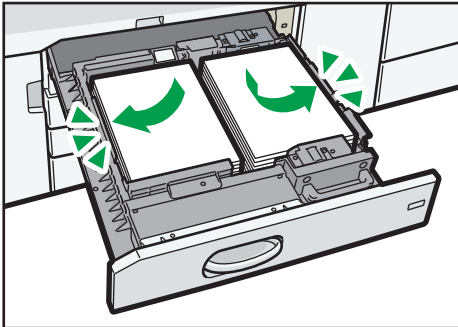

EBB001

- Left half of the tray pulled out

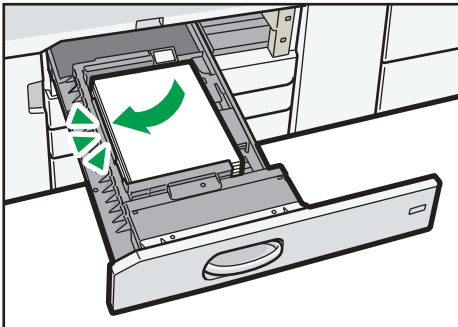

EBB002

Do not stack paper over the limit mark.

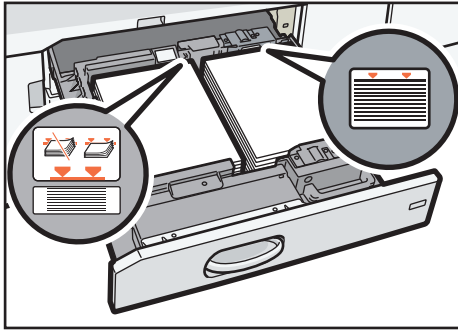

EBB003

3. Carefully push the paper tray fully in.

↓ Note

- You can load paper even if Tray 1 is in use. It is okay to pull out the left half of the tray while Tray 1 is in use.

Loading Paper into the A3/11 × 17 Tray Unit

🌐 Region A (mainly Europe)

A3/11 × 17 tray unit can hold A3 paper only. If you want to print on A4, B4 JIS, 11 × 17, 8 1/2 × 14, or 8 1/2 × 11, contact your service representative.

🌐 Region B (mainly North America)

A3/11 × 17 tray unit can hold 11 × 17 paper only. If you want to print on A3, A4, B4 JIS, 8 1/2 × 14, or 8 1/2 × 11, contact your service representative.

★ Important

- Check that the paper edges are aligned at the right side.

1. Check that paper in the paper tray is not being used, and then pull the tray carefully out until it stops.

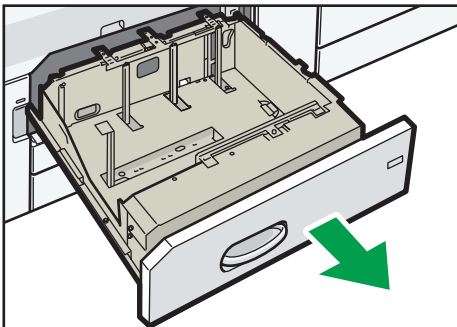

CVA004

2. Square the paper and load it print side down.

Do not stack paper over the limit mark.

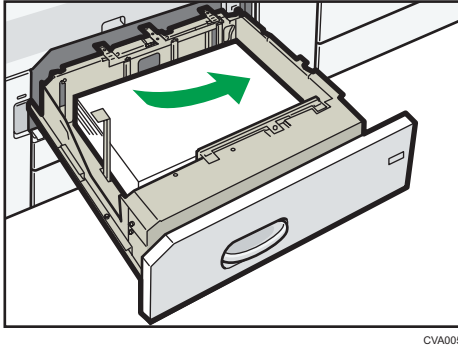

CVA005

3. Carefully push the paper tray fully in.

Loading Paper into Trays 2 and 3

Each paper tray is loaded in the same way.

Various sizes of paper can be loaded in Trays 2 and 3 by adjusting the positions of side fences and end fence. You can change paper sizes as shown below.

In the following example procedure, paper is loaded into Tray 2.

★ Important

- Check that the paper edges are aligned at the right side.
- If a paper tray is pushed vigorously when putting it back into place, the position of the tray's side fences may slip out of place.
- When loading a low number of sheets, be sure not to squeeze the side fences in too tightly. If the side fences are squeezed too tightly against the paper, the edges may crease, the paper may misfeed, or if it weighs between 52.3–65.9 g/m² (14.0–17.9 lb. Bond), it may wrinkle.

1. Check that paper in the paper tray is not being used, and then pull the tray carefully out until it stops.

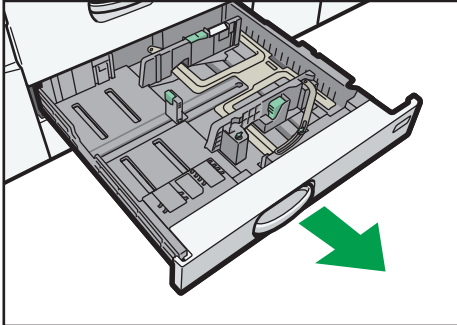

DRC251

2. Remove paper if loaded.
3. Release the lock on the side fence.

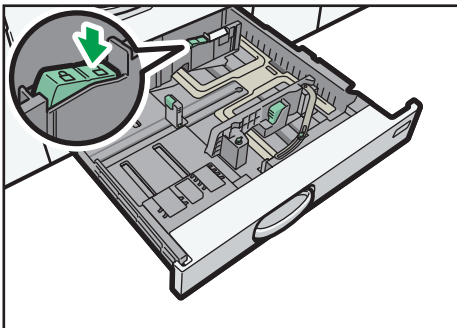

DRC256

4. Loosen the screws holding the side fences in position.

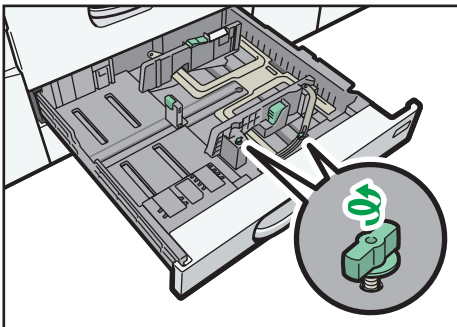

DRC257

5. While pressing down the release lever of the side fence, slide the side fences outward.

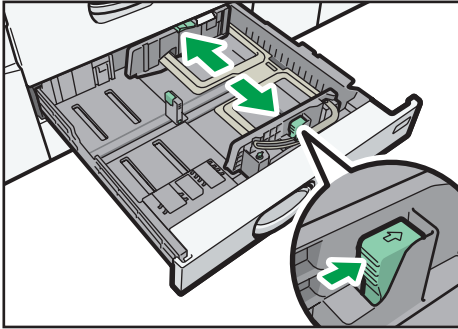

DRC258

6. While pinching the release lever of the end fence, slide the end fence outward.

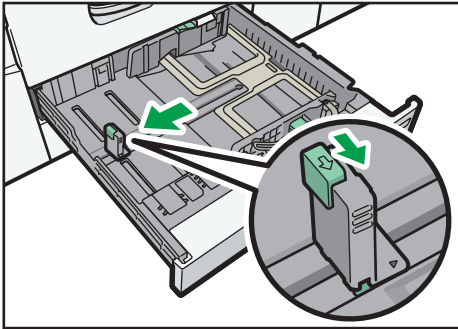

DRC259

8

7. Square the paper and load it print side down.

Do not stack paper over the limit mark.

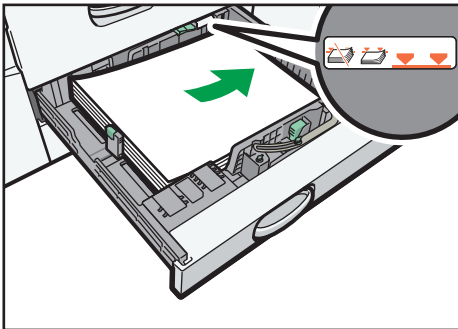

DRC260

8. Align the end and side fences gently against the paper you loaded.

Make sure that there is no space between the paper and the side fences or end fence.

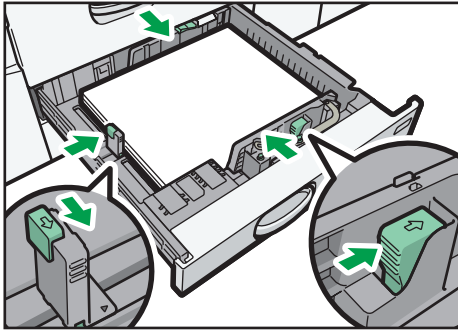

DRC261

9. Turn the screws slowly to fasten it in place.

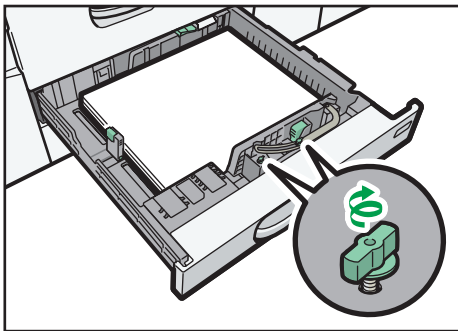

DRC262

10. Re-lock the side fences.

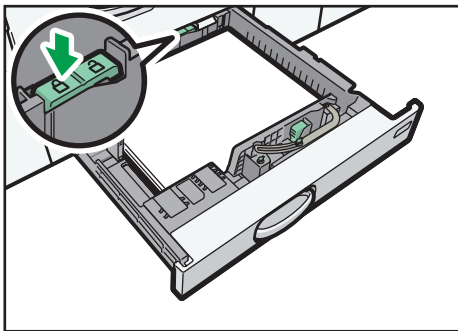

DRC263

11. Carefully push the paper tray fully in.

Note

- You can load envelopes in Trays 2 and 3. When loading envelopes, place them in the correct orientation. For details, see page 209 "Envelopes".

Loading tab stock into Trays 2 and 3

- When loading tab stock, always use the optional tab sheet holder.

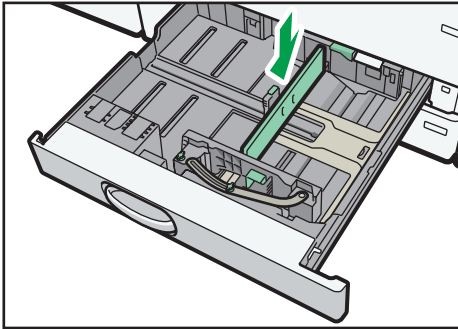

DRC253

- Load tab stock so that the side with the tab faces the tab sheet holder.
- When loading tab stock, adjust the end fence position so that the tab sheet holder will fit the tab stock.

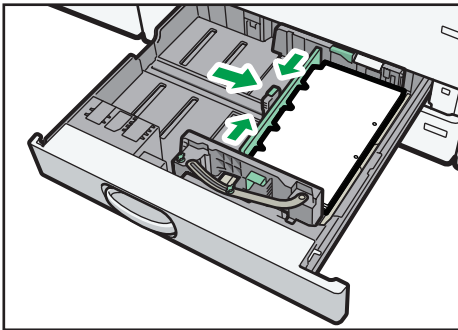

DRC254

Loading Paper into the Bypass Tray

Use the bypass tray to use transparencies, adhesive labels, translucent paper, and paper that cannot be loaded in the paper trays.

⚠ CAUTION

- When you open the bypass tray when a banner sheet guide tray is installed, do not put your hands on the front side and the back side of the place indicated by the label of the banner sheet guide tray. Otherwise, your fingers might be caught, resulting in injury.

★ Important

- The maximum number of sheets you can load at the same time depends on paper type. Do not stack paper over the limit mark. For the maximum number of sheets you can load, see page 189 "Recommended Paper Sizes and Types".

1. Open the bypass tray.

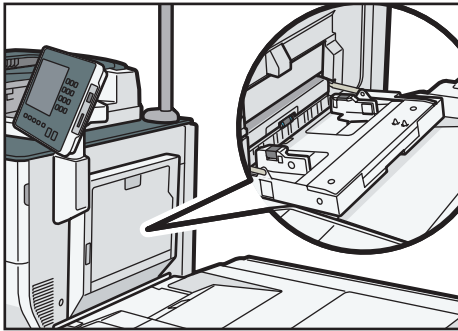

DRB168

2. Pull the extender out when loading paper whose size is larger than A4 or $8\frac{1}{2} \times 11$.
3. Release the locks on both of the paper guides.

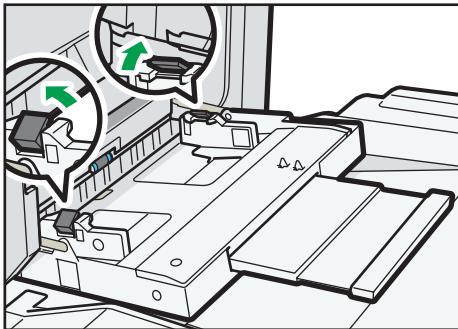

DRB154

4. Insert the paper print side up as far as it will go into the machine.
5. Put your fingers on the dimples on the front and rear paper guides and align the paper guides to the paper size.

If the guides are not flush against the paper, images might be skewed or paper misfeeds might occur.

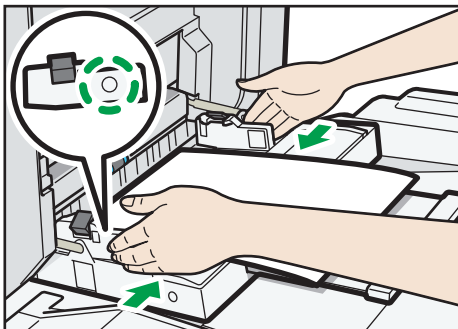

DRB169

6. While holding the paper guides with your hands, lock both of the paper guides again.

Make sure that the total of the gaps between the paper and the front and rear paper guides does not exceed 0.75 mm (0.03 inches).

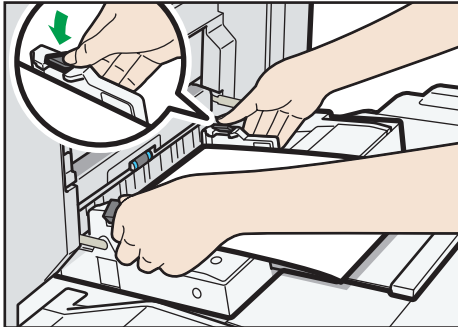

DRB158

Note

- When you use the bypass tray, it is recommended to load the paper in  orientation.
- Certain types of paper might not be detected properly when placed on the bypass tray. If this happens, remove the paper and place it on the bypass tray again.
- You do not need to pull the extender out if the banner sheet guide tray is installed.
- When loading thick paper, thin paper, transparencies, or translucent paper, specify the paper size and the paper type.
- Letterhead paper must be loaded in a specific orientation. For details, see page 186 "Loading Orientation-fixed Paper or Two-sided Paper".
- You can load envelopes into the bypass tray. Envelopes must be loaded in a specific orientation. For details, see page 209 "Envelopes".
- Specify the sizes of paper that are not automatically detected. For details about the sizes that can be detected automatically, see page 189 "Recommended Paper Sizes and Types". For details about how to specify sizes, see "Copying from the Bypass Tray", Copy/ Document Server.
- When copying from the bypass tray, see "Copying from the Bypass Tray", Copy/ Document Server.
- To load paper whose horizontal length is longer than 487.7 mm (19.20 inches), the multi bypass banner sheet tray or banner sheet guide tray is needed. For details about how to load paper in the multi bypass banner sheet tray, see page 175 "Loading paper into the multi bypass banner sheet tray".
- To load paper on the banner sheet guide tray, load it over the joint line of the bypass tray and the banner sheet guide tray.

Loading paper into the multi bypass banner sheet tray

1. Pull out the multi bypass banner sheet tray.

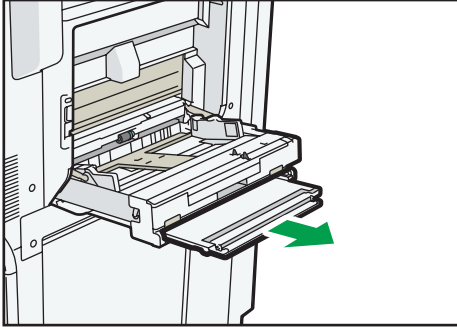

DRB181

2. After pulling out the multi bypass banner sheet tray, lift it until it clicks.

Raise the multi bypass banner sheet tray until it is at an angle of about 60 degrees with the floor.

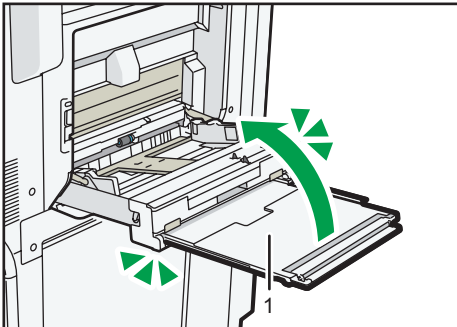

DRB182

1. Extender

3. Open the extender.

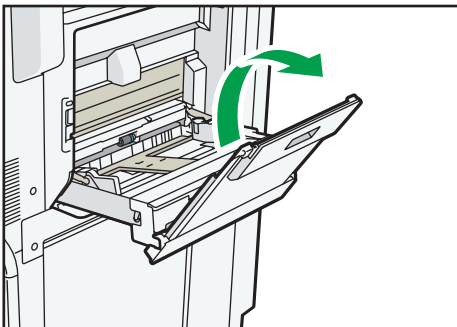

DRB183

4. Release the locks on both of the paper guides.
5. Insert the paper print side up as far as it will go into the machine.

6. Put your fingers on the dimples on the front and rear paper guides and align the paper guides to the paper size.

If the guides are not flush against the paper, images might be skewed or paper misfeeds might occur.

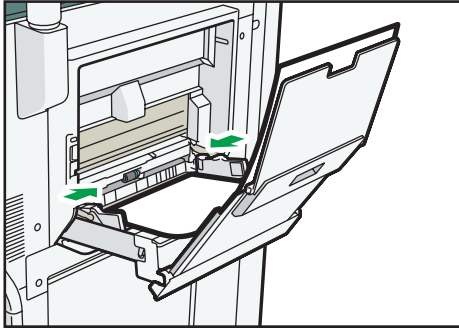

DRB184

7. While holding the paper guides with your hands, lock both of the paper guides again.

Make sure that the total of the gaps between the paper and the front and rear paper guides does not exceed 0.75 mm (0.03 inches).

Closing the multi bypass banner sheet tray

1. Lightly pull up the extender, and then fold it into the machine.

8

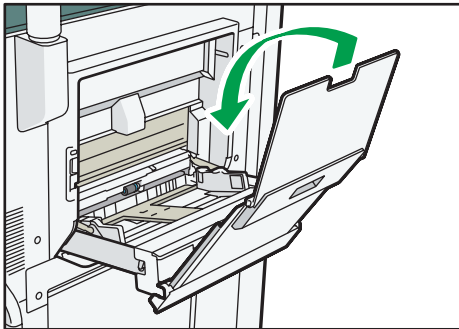

DRB185

2. Raise the multi bypass banner sheet tray towards the machine until it clicks, and then tilt it to the opposite side.

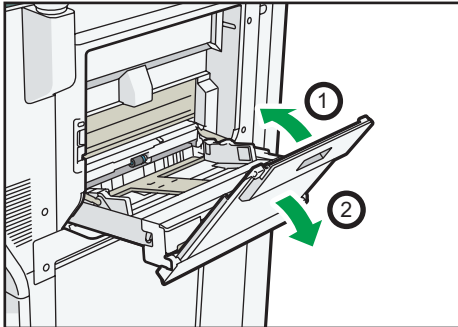

DRB186

3. Push the multi bypass banner sheet tray into its original position.

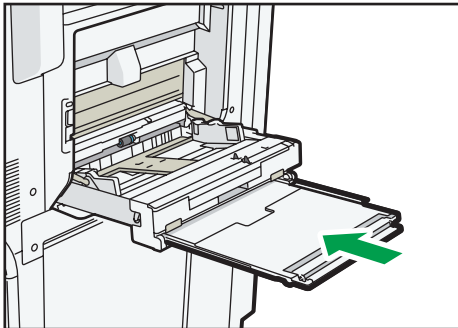

DRB187

Loading tab stock into the bypass tray

When loading tab stock, load tab stock so the tabs face to the right.

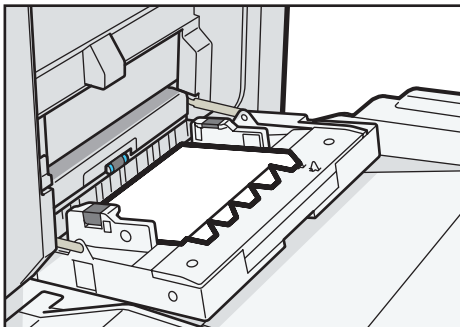

DRB170

Loading Paper into the Large Capacity Tray

Region A (mainly Europe)

The LCT can hold A4 paper only. If you want to print on 8 1/2 × 11 or B5 JIS from the LCT, contact your service representative.

Region B (mainly North America)

The LCT can hold 8 1/2 × 11 paper only. If you want to print on A4 or B5 JIS from the LCT, contact your service representative.

The extension unit is required to load A4, B4 JIS, 8 1/2 × 14, or 8 1/2 × 11.

★ Important

- Check that the paper edges are aligned at the left side.
1. Check that paper in the paper tray is not being used, and then open the top cover of the LCT.

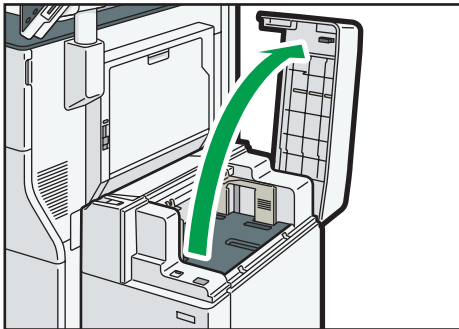

2. Load paper into the paper tray with the print side up.

Do not stack paper over the limit mark.

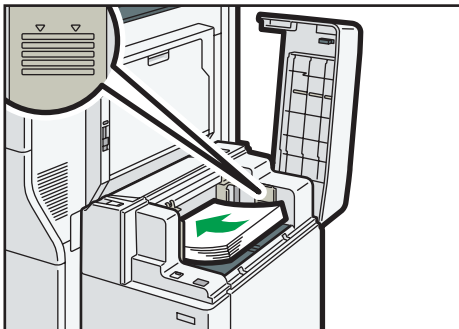

3. Press the [Down] key.

The key blinks while the bottom plate is moving down.

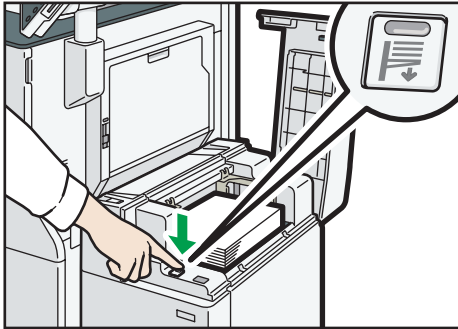

CVA025

4. Load paper by repeating Steps 2 and 3.
5. Close the top cover of the LCT.

Loading Paper into the Wide Large Capacity Tray

Various sizes of paper can be loaded in the wide LCT by adjusting the positions of side fences and end fence. You can change paper sizes as shown below.

★ Important

- Check that the paper edges are aligned with the left side.
1. Check that paper in the paper tray is not being used, and then pull the tray carefully out until it stops.

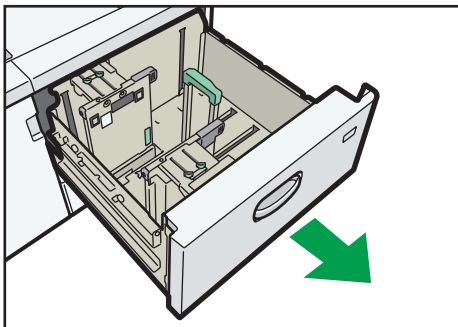

DRC170

2. Remove paper if loaded.

3. Loosen the screws holding the side fences in position.

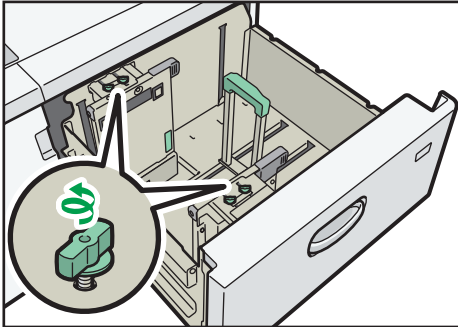

DRC182

4. Hold the indents at the bottom of the side fences with your fingers, and then slide the side fences outward.

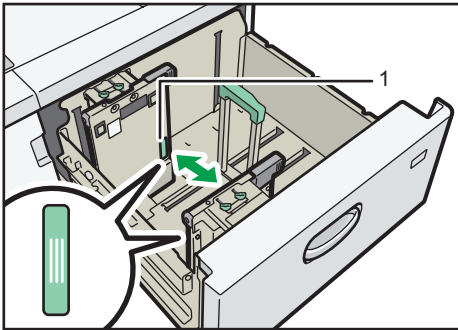

DRC183

1. Indents

5. While pressing the release button of the end fence, slide the end fence outward.

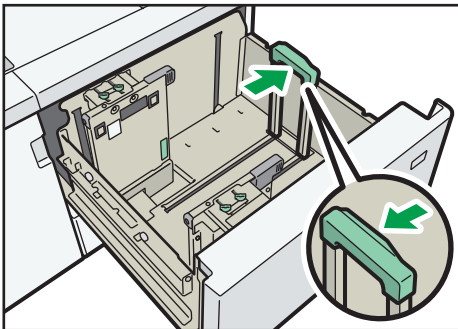

DRC184

6. Load paper into the paper tray with print side up.

Load a stack of paper about 5–10 mm (0.2–0.4 inches) high, using the symbol at the bottom of the side fence as a guide.

Make sure that the paper rest on top of the supporting plates on both sides.

Set the paper flush against the left fence and align the paper edges.

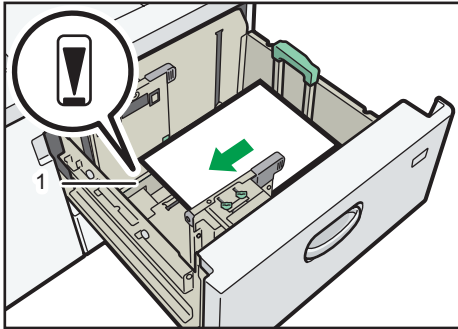

DRC185

1. Supporting plate

7. Hold the indents at the bottom of the side fences with your fingers, and adjust the side fences to the paper size.

Set the paper flush against the protrusions in the bottom of the inner side fence. Make sure that there is no space between the paper and the side fences.

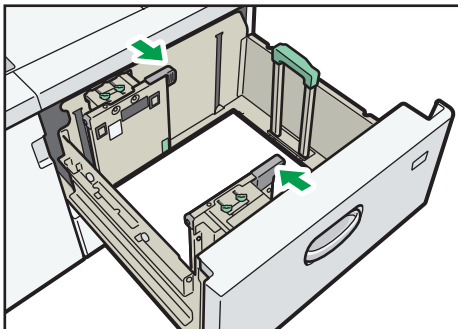

DRC186

Check that the positions of the scale numbers on the top of both of the side fences are almost the same. When loading regular size paper, align the screw holes on the side fences to the paper size mark.

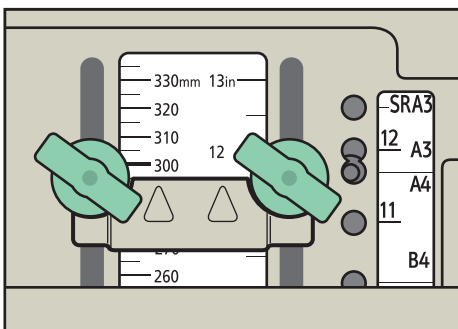

DRC190

8. Hold the inner side fence, and then tighten the screws to the inner side fence.

Fasten the front side fence in the same way.

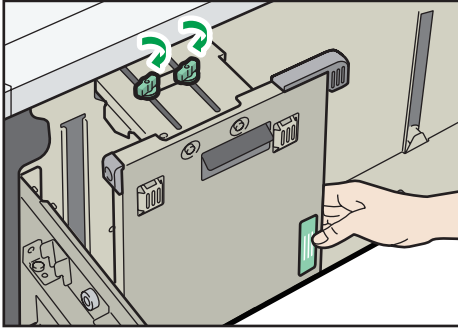

DRC187

9. Load additional sheets, if necessary.

Do not stack paper over the limit mark.

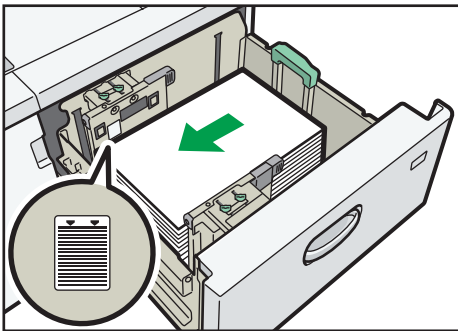

DRC188

10. While pressing the release button of the end fence, align the end fence gently against the paper you loaded.

Make sure that there is no space between the paper and end fence.

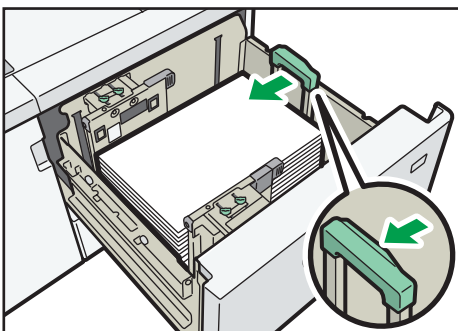

DRC189

11. Carefully slide the paper tray fully in.

If you push the paper tray too forcefully when you put it back in place, the position of the paper might change and print accuracy becomes lower.

Note

- If you select Paper Weight 6 to 9, [Coated Paper: High Gloss], [Coated: Glossy], [Coated: Matte], [Label Paper], or [Transparency] in [Tray Paper Settings], air is blown out automatically to fan the paper loaded in the wide LCT. Fan this paper before loading it. For details, see page 163 "Fanning the paper".
- You can load envelopes in the wide LCT. When loading envelopes, place them in the correct orientation. For details, see page 209 "Envelopes".

Loading Paper into the Interposer

Important

- Do not place anything on top of or leave documents on the sensor. This may lead to the paper size not being correctly scanned or paper jams.
- When using the Z-fold function, the paper in the interposer must be of the same size as the prints after they have been folded. If the paper in the interposer is larger than the Z-folded sheets, a misfeed might occur.
- Do not use paper that has already been printed onto by this machine.

1. Load paper orderly.

Do not stack paper over the limit mark.

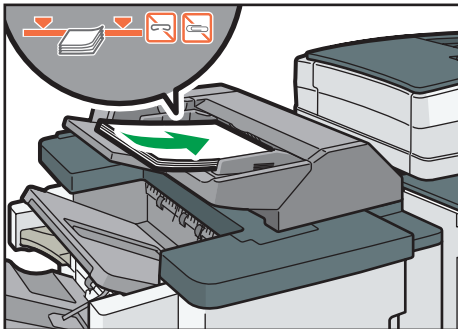

DRC172

2. Adjust the side fences to the paper size.

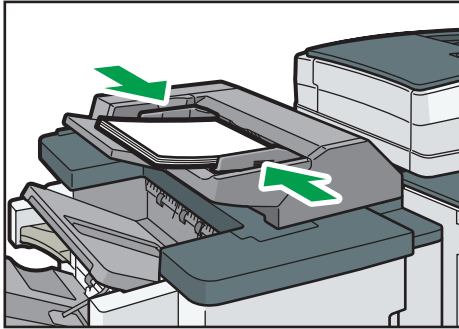

DRC173

Note

- Load paper with its printed side up (the front side).
- Load paper in the interposer in the same orientation as paper in the paper tray.
- The staple position or punch hole position will be on the left side of the paper, when you are facing the machine.
- To load the paper in the interposer, align the orientation of originals in the ADF as shown below.

Interposer	ADF

Loading Paper into the Twin Interposer

Important

- Do not place anything on top of or leave documents on the sensor. This may lead to the paper size not being correctly scanned or paper jams.

1. While pressing the release lever, align the side fences with the paper size to be loaded.

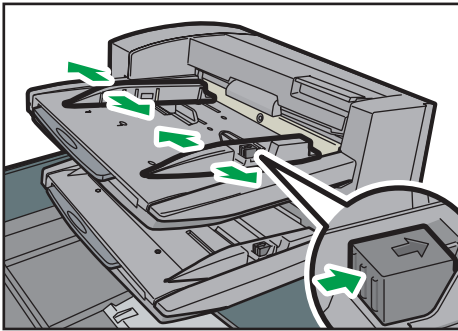

CVA032

2. Load paper orderly.

Do not stack paper over the limit mark.

Align the side fences gently against the paper you loaded, if necessary.

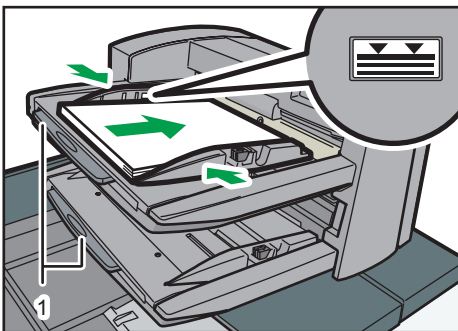





CVA033

1. Paper extenders

↓ Note

- Load paper with its printed side up (the front side).
- Load paper in the twin interposer in the same orientation as paper in the paper tray.
- The staple position or punch hole position will be on the left side of the paper, when you are facing the machine.
- When loading paper larger than A4 ($8\frac{1}{2} \times 11$) \square , pull out the paper extender.
- To load the paper in the twin interposer, align the orientation of originals in the ADF as shown below.

Twin interposer	ADF
	

Twin interposer	ADF
	

Loading Orientation-fixed Paper or Two-sided Paper

Orientation-fixed (top to bottom) or two-sided paper (for example, letterhead paper, punched paper, or copied paper) might not be printed correctly, depending on how the originals and paper are placed.



Settings for the User Tools

- Copier mode
Specify [Yes] for [Letterhead Setting] in [Input / Output] under the Copier / Document Server Features menu, and then place the original and paper as shown below.
- Printer mode
Specify [Auto Detect] or [On (Always)] for [Letterhead Setting] in [System] under the Printer Features menu, and then place the paper as shown below.

For details about the letterhead settings, see "Input / Output", Copy/ Document Server, or "System", Print.

Original orientation and paper orientation

The meanings of the icons are as follows:

Icon	Meaning
	Place or load paper scanned or printed side face up.
	Place or load paper scanned or printed side face down.













- Original orientation

Original orientation	Exposure glass	ADF
Readable Direction		
90 Degrees Counterclockwise	<ul style="list-style-type: none"> • Copy • Scanner 	
180 degrees		
90 Degrees Clockwise	<ul style="list-style-type: none"> • Copy • Scanner 	

- Paper orientation
 - Copier mode

Copy side	Tray 1	Trays 2–3	LCT	Bypass tray or wide LCT
One-sided		 		
Two-sided		 		

- Printer mode

Print side	Tray 1	Trays 2–3	LCT	Bypass tray or wide LCT
One-sided		 		 
Two-sided		 		 

Note

- In copier mode:
 - For details about how to make two-sided copies, see "Duplex Copying", Copy/ Document Server.
- In printer mode:
 - To print on letterhead paper when [Auto Detect] is specified for [Letterhead Setting], you must specify [Letterhead] as the paper type in the printer driver's settings.
 - If a print job is changed partway through printing from one-sided to two-sided printing, one-sided output after the first copy may be printed facing a different direction. To ensure all paper is output facing the same direction, specify different input trays for one-sided and two-sided printing. Note also that two-sided printing must be disabled for the tray specified for one-sided printing.
 - For details about how to make two-sided prints, see "Printing on Both Sides of Sheets", Print.

Recommended Paper









Recommended Paper Sizes and Types

This section describes recommended paper sizes and types.

★ Important





- If you use paper that curls, either because it is too dry or too damp, a staple clogging or paper jam may occur.
- Do not use paper designed for inkjet printers, as these may stick to the fusing unit and cause a misfeed.
- When you load transparencies, check the front and back of the sheets, and place them correctly, or a misfeed might occur.





Tray 1

Paper type and weight	Paper size	Paper capacity
52.3–300.0 g/m ² (14.0 lb. Bond–165.0 lb. Index) Paper Weight 1–Paper Weight 8	 Region A A4   Region B 8 1/2 × 11 	1,250 sheets × 2
52.3–300.0 g/m ² (14.0 lb. Bond–165.0 lb. Index) Paper Weight 1–Paper Weight 8	*1  Region A 8 1/2 × 11   Region B A4 	1,250 sheets × 2

*1 To load paper any of the sizes specified above, contact your service representative.

Tray 1 (A3/11 × 17 tray unit)



Paper type and weight	Paper size	Paper capacity
52.3–300.0 g/m ² (14.0 lb. Bond–165.0 lb. Index) Paper Weight 1–Paper Weight 8	 Region A A3   Region B 11 × 17 	1,000 sheets



Paper type and weight	Paper size	Paper capacity
52.3–300.0 g/m ² (14.0 lb. Bond–165.0 lb. Index) Paper Weight 1–Paper Weight 8	*1  Region A A4☐☐, B4 JIS☐, 11 × 17☐, 8 ¹ / ₂ × 14☐, 8 ¹ / ₂ × 11☐☐  Region B A3☐, A4☐☐, B4 JIS☐, 8 ¹ / ₂ × 14☐, 8 ¹ / ₂ × 11☐☐	1,000 sheets
52.3–300.0 g/m ² (14.0 lb. Bond–165.0 lb. Index) Paper Weight 1–Paper Weight 8	Custom size *2:  Region A Vertical: 210.0–305.0 mm Horizontal: 210.0–439.0 mm  Region B Vertical: 8.27–12.00 inches Horizontal: 8.27–17.28 inches	1,000 sheets











*1 To load paper any of the sizes specified above, contact your service representative.

*2 For details about how to load custom size paper, contact your service representative.

Trays 2 and 3

















Paper type and weight	Paper size	Paper capacity
52.3–300.0 g/m ² (14.0 lb. Bond–165.0 lb. Index) Paper Weight 1–Paper Weight 8	Paper sizes that can be detected automatically:  Region A A3☐, A4☐☐, A5☐, B4 JIS☐, B5 JIS☐☐, 8 ¹ / ₂ × 11☐, 13 × 19☐, SRA3☐  Region B A4☐, B5 JIS☐, 11 × 17☐, 8 ¹ / ₂ × 14☐, 8 ¹ / ₂ × 11☐☐, 7 ¹ / ₄ × 10 ¹ / ₂ ☐, 5 ¹ / ₂ × 8 ¹ / ₂ ☐, 12 × 18☐, 13 × 19☐	550 sheets



Paper type and weight	Paper size	Paper capacity
<p>52.3–300.0 g/m² (14.0 lb. Bond–165.0 lb. Index)</p> <p>Paper Weight 1–Paper Weight 8</p>	<p>Select the paper size using the Tray Paper Settings menu:</p> <p> Region A</p> <p>A5□, A6□, B6 JIS□, 11 × 17□, 8¹/₂ × 14□, 8¹/₂ × 13□, 8¹/₂ × 11□, 8¹/₄ × 14□, 8¹/₄ × 13□, 8 × 13□, 8 × 10□, 7¹/₄ × 10¹/₂□, 5¹/₂ × 8¹/₂□, 8K□, 16K□, 12 × 18□, 11 × 15□, 11 × 14□, 10 × 15□, 10 × 14□, 13 × 19¹/₅□, 12³/₅ × 19¹/₅□, 12³/₅ × 18¹/₂□, 13 × 18□, SRA4□, 226 × 310 mm□, 310 × 432 mm□, 8¹/₂ × 13²/₅□</p> <p> Region B</p> <p>A3□, A4□, A5□, A6□, B4 JIS□, B5 JIS□, B6 JIS□, 8¹/₂ × 13□, 8¹/₄ × 14□, 8¹/₄ × 13□, 8 × 13□, 8 × 10□, 7¹/₄ × 10¹/₂□, 5¹/₂ × 8¹/₂□, 8K□, 16K□, 11 × 15□, 11 × 14□, 10 × 15□, 10 × 14□, 13 × 19¹/₅□, 12³/₅ × 19¹/₅□, 12³/₅ × 18¹/₂□, 13 × 18□, SRA3□, SRA4□, 226 × 310 mm□, 310 × 432 mm□, 8¹/₂ × 13²/₅□</p>	550 sheets





Paper type and weight	Paper size	Paper capacity
52.3–300.0 g/m ² (14.0 lb. Bond–165.0 lb. Index) Paper Weight 1–Paper Weight 8	Custom size:  Region A Vertical: 100.0–330.2 mm Horizontal: 139.7–487.7 mm  Region B Vertical: 3.94–13.00 inches Horizontal: 5.50–19.20 inches	550 sheets
Tab stock* ¹ 52.3–300.0 g/m ² (14.0 lb. Bond–165.0 lb. Index)	A4  , 8 1/2 × 14  , 8 1/2 × 11 	200 sheets
Envelopes	Select the paper size using the Tray Paper Settings menu: 4 1/8 × 9 1/2  , C5 Env  , C6 Env  , DL Env 	<ul style="list-style-type: none"> : 50 sheets : Double flap: 15 sheets Single flap: 25 sheets



*1 The tab sheet holder is required.

















Bypass tray

Paper type and weight	Paper size	Paper capacity
52.3–360.0 g/m ² (14.0 Bond–198.0 lb. Index) Paper Weight 1–Paper Weight 9	Paper sizes that can be detected automatically:  Region A A3  , A4  , A5  , A6  , B4 JIS  , B5 JIS  , B6 JIS  , 13 × 19  , SRA3   Region B 11 × 17  , 8 1/2 × 11  , 5 1/2 × 8 1/2  , 12 × 18  , 13 × 19  , SRA3 	<ul style="list-style-type: none"> 250 sheets Paper Weight 5: 100 sheets Paper Weight 6–Paper Weight 7: 50 sheets Paper Weight 8: 40 sheets Paper Weight 9: 35 sheets

Paper type and weight	Paper size	Paper capacity
52.3–360.0 g/m ² (14.0 Bond–198.0 lb. Index) Paper Weight 1–Paper Weight 9	*1  Region A 11 × 17□, 8 ¹ / ₂ × 14□, 8 ¹ / ₂ × 13□, 8 ¹ / ₂ × 11□□, 8 ¹ / ₄ × 14□, 8 ¹ / ₄ × 13□, 8 × 13□, 8 × 10□, 7 ¹ / ₄ × 10 ¹ / ₂ □□, 5 ¹ / ₂ × 8 ¹ / ₂ □□, 12 × 18□, 11 × 15□, 11 × 14□, 10 × 15□, 10 × 14□, 13 × 19 ¹ / ₅ □, 12 ³ / ₅ × 19 ¹ / ₅ □, 12 ³ / ₅ × 18 ¹ / ₂ □, 13 × 18□, SRA4□□, 226 × 310 mm□□, 310 × 432 mm□, 8 ¹ / ₂ × 13 ² / ₅ □, 4 ¹ / ₅ × 5 ¹ / ₂ □  Region B A3□, A4□□, A5□□, A6□, B4 JIS□, B5 JIS□□, B6 JIS□, 8 ¹ / ₂ × 14□, 8 ¹ / ₂ × 13□, 8 ¹ / ₄ × 14□, 8 ¹ / ₄ × 13□, 8 × 13□, 8 × 10□, 7 ¹ / ₄ × 10 ¹ / ₂ □□, 11 × 15□, 11 × 14□, 10 × 15□, 10 × 14□, 13 × 19 ¹ / ₅ □, 12 ³ / ₅ × 19 ¹ / ₅ □, 12 ³ / ₅ × 18 ¹ / ₂ □, 13 × 18□, SRA4□□, 226 × 310 mm□□, 310 × 432 mm□, 8 ¹ / ₂ × 13 ² / ₅ □, 4 ¹ / ₅ × 5 ¹ / ₂ □	<ul style="list-style-type: none"> • 250 sheets • Paper Weight 5: 100 sheets • Paper Weight 6–Paper Weight 7: 50 sheets • Paper Weight 8: 40 sheets • Paper Weight 9: 35 sheets

Paper type and weight	Paper size	Paper capacity
52.3–360.0 g/m ² (14.0 Bond–198.0 lb. Index) Paper Weight 1–Paper Weight 9	Custom size ^{*2} :  Region A Vertical: 90.0–330.2 mm Horizontal: 139.7–487.7 mm ^{*3}  Region B Vertical: 3.55–13.00 inches Horizontal: 5.50–19.20 inches ^{*3}	<ul style="list-style-type: none"> • 250 sheets ^{*4} • Paper Weight 5: 100 sheets • Paper Weight 6–Paper Weight 7: 50 sheets • Paper Weight 8: 40 sheets • Paper Weight 9: 35 sheets
Translucent paper	A3, A4, B4 JIS, B5 JIS	125 sheets
Transparencies	A4, 8 1/2 × 11	125 sheets
High Gloss Coated Paper (Matte) Coated Paper (Glossy)	Paper sizes that can be detected automatically:  Region A A3, A4, A5, A6, B4 JIS, B5 JIS, B6 JIS, 13 × 19, SRA3  Region B 11 × 17, 8 1/2 × 11, 5 1/2 × 8 1/2, 12 × 18, 13 × 19, SRA3	<ul style="list-style-type: none"> • 250 sheets • Paper Weight 5: 100 sheets • Paper Weight 6–Paper Weight 7: 50 sheets • Paper Weight 8: 40 sheets • Paper Weight 9: 35 sheets <p>^{*6}</p>

Paper type and weight	Paper size	Paper capacity
High Gloss Coated Paper (Matte) Coated Paper (Glossy)	<p>*1</p> <p> Region A</p> <p>11 × 17□, 8¹/₂ × 14□, 8¹/₂ × 13□, 8¹/₂ × 11□□, 8¹/₄ × 14□, 8¹/₄ × 13□, 8 × 13□, 8 × 10□, 7¹/₄ × 10¹/₂□□, 5¹/₂ × 8¹/₂□□,</p> <p>12 × 18□, 11 × 15□, 11 × 14□, 10 × 15□, 10 × 14□, 13 × 19¹/₅□, 12³/₅ × 19¹/₅□, 12³/₅ × 18¹/₂□, 13 × 18□, SRA4□□, 226 × 310 mm□□, 310 × 432 mm□, 8¹/₂ × 13²/₅□, 4¹/₅ × 5¹/₂□</p> <p> Region B</p> <p>A3□, A4□□, A5□□, A6□, B4 JIS□, B5 JIS□□, B6 JIS□, 8¹/₂ × 14□, 8¹/₂ × 13□, 8¹/₄ × 14□, 8¹/₄ × 13□, 8 × 13□, 8 × 10□, 7¹/₄ × 10¹/₂□□,</p> <p>11 × 15□, 11 × 14□, 10 × 15□, 10 × 14□, 13 × 19¹/₅□, 12³/₅ × 19¹/₅□, 12³/₅ × 18¹/₂□, 13 × 18□, SRA4□□, 226 × 310 mm□□, 310 × 432 mm□, 8¹/₂ × 13²/₅□, 4¹/₅ × 5¹/₂□</p>	<ul style="list-style-type: none"> • 250 sheets • Paper Weight 5: 100 sheets • Paper Weight 6– Paper Weight 7: 50 sheets • Paper Weight 8: 40 sheets • Paper Weight 9: 35 sheets <p>*6</p>

Paper type and weight	Paper size	Paper capacity
High Gloss Coated Paper (Matte) Coated Paper (Glossy)	Custom size ^{*2} :  Region A Vertical: 90.0–330.2 mm Horizontal: 139.7–487.7 mm ^{*3}  Region B Vertical: 3.55–13.00 inches Horizontal: 5.50–19.20 inches ^{*3}	<ul style="list-style-type: none"> • 250 sheets ^{*4} • Paper Weight 5: 100 sheets • Paper Weight 6–Paper Weight 7: 50 sheets • Paper Weight 8: 40 sheets • Paper Weight 9: 35 sheets ^{*6}
Label paper (adhesive labels)	A4  , B4 JIS 	1 sheet
Tab stock 52.3–360.0 g/m ² (14.0 lb. Bond–198.0 lb. Index)	A4  , 8 1/2 × 14  , 8 1/2 × 11 	50 sheets
Envelopes	^{*1} , ^{*5} 4 1/8 × 9 1/2  , 3 7/8 × 7 1/2   , C5 Env  , C6 Env  , DL Env  	<ul style="list-style-type: none"> • : 20 sheets • : Double flap: 7 sheets Single flap: 10 sheets

^{*1} Select the paper size. For details, see "Changing Tray Paper Settings", Paper Settings.

^{*2} Enter the paper size. For details, see "Changing Tray Paper Settings", Paper Settings.

^{*3} When the multi bypass banner sheet tray or the banner sheet guide tray is installed, available paper length is 139.7–700.0 mm (5.50–27.55 inches).

^{*4} When the multi bypass banner sheet tray is installed, you can load banner sheets that are from 487.8–700.0 mm (about 19.21–27.55 inches) long. The number of sheets that you can load depends on the basis weight shown in the table below.











Paper thickness	Basis weight (g/m ²)	Paper capacity
Paper Weight 1–Paper Weight 3	52.3–100.9	50 sheets
Paper Weight 4–Paper Weight 5	101.0–150.0	25 sheets

Paper thickness	Basis weight (g/m ²)	Paper capacity
Paper Weight 6–Paper Weight 8	150.1–300.0	10 sheets

*5 Available paper sizes differ depending on the options that are installed. For details about the available paper sizes for each option, see the specifications of each option.





*6 If a paper jam occurs or if the machine makes a strange noise when feeding stacks of paper, feed the paper from the bypass tray one sheet at a time.



LCT

Paper type and weight	Paper size	Paper capacity
52.3–216.0 g/m ² (14.0 lb. Bond–79.9 lb. Cover) Paper Weight 1–Paper Weight 6	 Region A A4   Region B 8 1/2 × 11 	4,400 sheets
52.3–216.0 g/m ² (14.0 lb. Bond–79.9 lb. Cover) Paper Weight 1–Paper Weight 6	*1  Region A B5 JIS  , 8 1/2 × 11   Region B A4  , B5 JIS 	4,400 sheets

*1 To load paper any of the sizes specified above, contact your service representative.



Extension unit



Paper type and weight	Paper size	Paper capacity
52.3–216.0 g/m ² (14.0 lb. Bond–79.9 lb. Cover) Paper Weight 1–Paper Weight 6	 Region A A4   Region B 8 1/2 × 11 	2,500 sheets



Paper type and weight	Paper size	Paper capacity
52.3–216.0 g/m ² (14.0 lb. Bond–79.9 lb. Cover) Paper Weight 1–Paper Weight 6	*1  Region A A4□, B4 JIS□, B5 JIS□, 8 ¹ / ₂ × 14□, 8 ¹ / ₂ × 11□□  Region B A4□□, B4 JIS□, B5 JIS□, 8 ¹ / ₂ × 14□, 8 ¹ / ₂ × 11□	2,500 sheets



*1 To load paper any of the sizes specified above, contact your service representative.





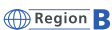





Wide LCT

Paper type and weight	Paper size	Paper capacity
52.3–360.0 g/m ² (14.0 lb. Bond–198.0 lb. Index) Paper Weight 1–Paper Weight 9	Paper sizes that can be detected automatically:  Region A A3□, A4□□, A5□□, B4 JIS□, B5 JIS□, 11 × 17□, 8 ¹ / ₂ × 11□, 8 × 13□, 5 ¹ / ₂ × 8 ¹ / ₂ □, SRA3□  Region B A3□, A4□, A5□, B4 JIS□, B5 JIS□, 11 × 17□, 8 ¹ / ₂ × 11□□, 8 × 13□, 5 ¹ / ₂ × 8 ¹ / ₂ □□, 12 × 18□	2,200 sheets

Paper type and weight	Paper size	Paper capacity
<p>52.3–360.0 g/m² (14.0 lb. Bond–198.0 lb. Index)</p> <p>Paper Weight 1–Paper Weight 9</p>	<p>Select the paper size using the Tray Paper Settings menu:</p> <p> Region A</p> <p>A6[*], B5 JIS, B6 JIS[*], 8¹/₂ × 14, 8¹/₂ × 13, 8¹/₂ × 11, 8¹/₄ × 14, 8¹/₄ × 13, 7¹/₄ × 10¹/₂, 5¹/₂ × 8¹/₂,</p> <p>8K, 16K, 12 × 18, 11 × 15, 11 × 14, 10 × 15, 10 × 14, 13 × 19¹/₅, 13 × 19, 12³/₅ × 19¹/₅, 12³/₅ × 18¹/₂, 13 × 18, SRA4, 226 × 310 mm, 310 × 432 mm, 8¹/₂ × 13²/₅, 4¹/₅ × 5¹/₂[*]</p> <p> Region B</p> <p>A4, A5, A6[*], B5 JIS, B6 JIS[*], 8¹/₂ × 14, 8¹/₂ × 13, 8¹/₄ × 14, 8¹/₄ × 13, 7¹/₄ × 10¹/₂,</p> <p>8K, 16K, 11 × 15, 11 × 14, 10 × 15, 10 × 14, 13 × 19¹/₅, 13 × 19, 12³/₅ × 19¹/₅, 12³/₅ × 18¹/₂, 13 × 18, SRA3, SRA4, 226 × 310 mm, 310 × 432 mm, 8¹/₂ × 13²/₅, 4¹/₅ × 5¹/₂</p>	<p>2,200 sheets</p>





Paper type and weight	Paper size	Paper capacity
52.3–360.0 g/m ² (14.0 lb. Bond–198.0 lb. Index) Paper Weight 1–Paper Weight 9	Custom size:  Region A Vertical: 100.0–330.2 mm * ¹ Horizontal: 139.7–487.7 mm  Region B Vertical: 3.94–13.00 inches * ¹ Horizontal: 5.50–19.20 inches	2,200 sheets
Translucent paper	A3☐, A4☐☐, B4 JIS☐, B5 JIS☐☐	1,000 sheets
Transparencies	A4☐☐, 8 1/2 × 11☐☐	1,000 sheets
High Gloss Coated Paper (Matte) Coated Paper (Glossy)	Paper sizes that can be detected automatically:  Region A A3☐, A4☐☐, A5☐☐, B4 JIS☐, B5 JIS☐, 11 × 17☐, 8 1/2 × 11☐☐, 8 × 13☐, 5 1/2 × 8 1/2☐☐, SRA3☐  Region B A3☐, A4☐, A5☐, B4 JIS☐, B5 JIS☐, 11 × 17☐, 8 1/2 × 11☐☐, 8 × 13☐, 5 1/2 × 8 1/2☐☐, 12 × 18☐	2,200 sheets * ⁴

Paper type and weight	Paper size	Paper capacity
High Gloss Coated Paper (Matte) Coated Paper (Glossy)	Select the paper size using the Tray Paper Settings menu:  Region A A6 [*] , B5 JIS [*] , B6 JIS [*] , 8 ¹ / ₂ × 14 [*] , 8 ¹ / ₂ × 13 [*] , 8 ¹ / ₂ × 11 [*] , 8 ¹ / ₄ × 14 [*] , 8 ¹ / ₄ × 13 [*] , 7 ¹ / ₄ × 10 ¹ / ₂ [*] , 5 ¹ / ₂ × 8 ¹ / ₂ [*] , 8K [*] , 16K [*] , 12 × 18 [*] , 11 × 15 [*] , 11 × 14 [*] , 10 × 15 [*] , 10 × 14 [*] , 13 × 19 ¹ / ₅ [*] , 13 × 19 [*] , 12 ³ / ₅ × 19 ¹ / ₅ [*] , 12 ³ / ₅ × 18 ¹ / ₂ [*] , 13 × 18 [*] , SRA4 [*] , 226 × 310 mm [*] , 310 × 432 mm [*] , 8 ¹ / ₂ × 13 ² / ₅ [*] , 4 ¹ / ₅ × 5 ¹ / ₂ [*]  Region B A4 [*] , A5 [*] , A6 [*] , B5 JIS [*] , B6 JIS [*] , 8 ¹ / ₂ × 14 [*] , 8 ¹ / ₂ × 13 [*] , 8 ¹ / ₄ × 14 [*] , 8 ¹ / ₄ × 13 [*] , 7 ¹ / ₄ × 10 ¹ / ₂ [*] , 8K [*] , 16K [*] , 11 × 15 [*] , 11 × 14 [*] , 10 × 15 [*] , 10 × 14 [*] , 13 × 19 ¹ / ₅ [*] , 13 × 19 [*] , 12 ³ / ₅ × 19 ¹ / ₅ [*] , 12 ³ / ₅ × 18 ¹ / ₂ [*] , 13 × 18 [*] , SRA3 [*] , SRA4 [*] , 226 × 310 mm [*] , 310 × 432 mm [*] , 8 ¹ / ₂ × 13 ² / ₅ [*] , 4 ¹ / ₅ × 5 ¹ / ₂ [*]	2,200 sheets *4

Paper type and weight	Paper size	Paper capacity
High Gloss Coated Paper (Matte) Coated Paper (Glossy)	Custom size:  Region A Vertical: 100.0–330.2 mm ^{*1} Horizontal: 139.7–487.7 mm  Region B Vertical: 3.94–13.00 inches ^{*1} Horizontal: 5.50–19.20 inches	2,200 sheets ^{*4}
Label paper (adhesive labels)	A4  , B4 JIS 	20 sheet
Tab stock ^{*2} 52.3–360.0 g/m ² (14.0 lb. Bond–198.0 lb. Index)	A4  , 8 1/2 × 14  , 8 1/2 × 11 	1,000 sheets
Envelopes	^{*3} Select the paper size using the Tray Paper Settings menu: 4 1/8 × 9 1/2  ^{*1} , C5 Env  , C6 Env  ^{*1} , DL Env  ^{*1}	10 sheets



- *1 The postcard side fences are required to load paper that is between 100.0 and 139.2 mm (3.94 and 5.48 inches).
- *2 The tab sheet fence is required.
- *3 Available paper sizes differ depending on the options that are installed. For details about the available paper sizes for each option, see the specifications of each option.
- *4 If a paper jam occurs or if the machine makes a strange noise when feeding stacks of paper, feed the paper from the bypass tray one sheet at a time.





Interposer

Paper type and weight	Paper size	Paper capacity
64.0–216.0 g/m ² (17.1 lb. Bond–79.9 lb. Cover) Paper Weight 1–Paper Weight 6	<p>Paper sizes that can be detected automatically:</p> <p> Region A</p> <p>A3☐, A4☐☐, A5☐☐, B4 JIS☐, B5 JIS☐☐, 8¹/₂ × 13☐, 8K☐, 16K☐☐</p> <p> Region B</p> <p>A3☐, A4☐☐, B5 JIS☐, 11 × 17☐, 8¹/₂ × 14☐, 8¹/₂ × 11☐☐, 7¹/₄ × 10¹/₂☐, 5¹/₂ × 8¹/₂☐☐, 10 × 14☐, 8¹/₂ × 13²/₅☐</p>	200 sheets
64.0–216.0 g/m ² (17.1 lb. Bond–79.9 lb. Cover) Paper Weight 1–Paper Weight 6	<p>*1</p> <p> Region A</p> <p>11 × 17☐, 8¹/₂ × 11☐☐, 8¹/₄ × 13☐, 8 × 13☐, 12 × 18☐</p> <p> Region B</p> <p>8¹/₂ × 13☐, 7¹/₄ × 10¹/₂☐, 12 × 18☐</p>	200 sheets

*1 If you want to make these sizes detectable, contact your service representative.

Twin interposer

Paper type and weight	Paper size	Paper capacity
64.0–216.0 g/m ² (17.1 lb. Bond–79.9 lb. Cover) Paper Weight 1–Paper Weight 6	Paper sizes that can be detected automatically:  Region A A3☐, A4☐☐, A5☐☐, B4 JIS☐, B5 JIS☐, 11 × 17☐, 8 ¹ / ₂ × 11☐, 8 × 13☐, 5 ¹ / ₂ × 8 ¹ / ₂ ☐, SRA3☐  Region B A3☐, A4☐, A5☐, B4 JIS☐, B5 JIS☐, 11 × 17☐, 8 ¹ / ₂ × 11☐☐, 8 × 13☐, 5 ¹ / ₂ × 8 ¹ / ₂ ☐☐, 12 × 18☐	240 sheets × 2

Paper type and weight	Paper size	Paper capacity
<p>64.0–216.0 g/m² (17.1 lb. Bond–79.9 lb. Cover)</p> <p>Paper Weight 1–Paper Weight 6</p>	<p>Select the paper size using the Tray Paper Settings menu:</p> <p> Region A</p> <p>B5 JIS, 8 1/2 × 14, 8 1/2 × 13, 8 1/2 × 11, 8 1/4 × 14, 8 1/4 × 13, 7 1/4 × 10 1/2, 5 1/2 × 8 1/2, 8K, 16K, 12 × 18, 11 × 15, 11 × 14, 10 × 15, 10 × 14, 13 × 19 1/5, 13 × 19, 12 3/5 × 19 1/5, 12 3/5 × 18 1/2, 13 × 18, 226 × 310 mm, 310 × 432 mm, SRA4, 8 1/2 × 13 2/5</p> <p> Region B</p> <p>A4, A5, B5 JIS, 8 1/2 × 14, 8 1/2 × 13, 8 1/4 × 14, 8 1/4 × 13, 7 1/4 × 10 1/2, 11 × 15, 11 × 14, 10 × 15, 10 × 14, 13 × 19 1/5, 13 × 19, 12 3/5 × 19 1/5, 12 3/5 × 18 1/2, 13 × 18, SRA3, SRA4, 226 × 310 mm, 310 × 432 mm, 8 1/2 × 13 2/5</p>	240 sheets × 2
<p>64.0–216.0 g/m² (17.1 lb. Bond–79.9 lb. Cover)</p> <p>Paper Weight 1–Paper Weight 6</p>	<p>Custom size:</p> <p> Region A</p> <p>Vertical: 139.7–330.2 mm Horizontal: 139.7–487.7 mm</p> <p> Region B</p> <p>Vertical: 5.50–13.00 inches Horizontal: 5.50–19.20 inches</p>	240 sheets × 2

Paper Thickness



Paper Thickness *1	Metric	Bond paper	Cover paper	Index paper
Paper Weight 1 *2	52.3–65.9 g/m ²	14.0–17.9 lb. Bond	19.0–24.0 lb. Cover	29.0–36.0 lb. Index
Paper Weight 2	66.0–80.9 g/m ²	18.0–21.9 lb. Bond	24.1–29.9 lb. Cover	36.1–44.9 lb. Index
Paper Weight 3	81.0–100.9 g/m ²	22.0–27.0 lb. Bond	30.0–37.0 lb. Cover	45.0–55.9 lb. Index
Paper Weight 4	101.0–127.4 g/m ²	27.1–34.0 lb. Bond	37.1–46.9 lb. Cover	56.0–70.0 lb. Index
Paper Weight 5	127.5–150.0 g/m ²	34.1–40.0 lb. Bond	47.0–55.0 lb. Cover	70.1–82.9 lb. Index
Paper Weight 6	150.1–216.0 g/m ²	40.1–57.9 lb. Bond	55.1–79.9 lb. Cover	83.0–119.0 lb. Index
Paper Weight 7	216.1–256.0 g/m ²	58.0–68.0 lb. Bond	80.0–94.0 lb. Cover	119.1–141.0 lb. Index
Paper Weight 8	256.1–300.0 g/m ²	68.1–80.0 lb. Bond	94.1–110.0 lb. Cover	141.1–165.0 lb. Index
Paper Weight 9	300.1–360.0 g/m ²	80.1–96.0 lb. Bond	110.1–132.0 lb. Cover	165.1–198.0 lb. Index

*1 Print quality will decrease if the paper you are using is close to the minimum or maximum weight. Change the paper weight setting to thinner or thicker.

*2 When loading paper of 52.3–65.9 g/m² (14.0–17.9 lb. Bond), the edges may crease or the paper misfeed depending on the paper type.

Note

- Certain types of paper, such as translucent paper or transparencies, may produce noise when delivered. This noise does not indicate a problem and print quality is unaffected.
- The paper capacity described in the tables above is an example. Actual paper capacity might be lower, depending on the paper type.
- When loading paper, make sure the stack height does not exceed the limit mark of the paper tray.
- If multiple sheet feeding occurs, fan sheets thoroughly or load sheets one by one from the bypass tray.

- Flatten out curled sheets before loading them.
- Depending on the paper sizes and types, the copy/print speed may be slower than usual.
- When loading thick paper of 127.5–360.0 g/m² (47.0 lb. Cover–198.0 lb. Index), see page 208 "Thick paper".
- When loading envelopes, see page 209 "Envelopes".
- When copying or printing onto letterhead paper, the paper placing orientation is different depending on which function you are using. For details, see page 186 "Loading Orientation-fixed Paper or Two-sided Paper".
- If you load paper of the same size and same type in two or more trays, the machine automatically feeds from one of the trays in which [Yes] is selected for [Apply Auto Paper Select] when the first tray in use runs out of paper. This function is called Auto Tray Switching. This saves interrupting a copy run to replenish paper when making a large number of copies. You can specify the paper type of the paper trays under [Paper Tray] tab. For details, see "Tray Paper Settings", Paper Settings. For details about the Auto Tray Switching function, see "General Features", Copy/ Document Server.
- When loading label paper:
 - We recommend that you use specified label paper.
 - It is recommended to place one sheet at a time.
 - It is recommended to load the paper in  orientation. When you load paper in  orientation, label paper may curl after it is printed.
 - Select [Label Paper] for [Paper Type] in [Tray Paper Settings].
- When loading transparencies:
 - It is recommended to place one sheet at a time.
 - When copying onto transparencies, see "Copying onto Transparencies", Copy/ Document Server.
 - Fan transparencies thoroughly whenever you use them. This prevents transparencies from sticking together, and from feeding incorrectly.
 - Remove copied or printed sheets one by one.
- When loading translucent paper:
 - It is recommended to place one sheet at a time.
 - When loading translucent paper, always use long grain paper, and set the paper direction according to the grain.
 - Translucent paper easily absorbs humidity and becomes curled. Remove curl in the translucent paper before loading.
 - Remove copied or printed sheets one by one.
- When loading coated paper:



- If you want to use glossy paper, select [Coated: Glossy] for [Paper Type]. If you want to use matted paper (including silk, dull, and satin paper), select [Coated: Matte] for [Paper Type]. If you want to use high-gloss paper, select [Coated: High Gloss] for [Paper Type]. For details about the settings for using coated paper with custom paper, see "Registering a Custom Paper", Paper Settings.
- You must specify an appropriate paper thickness under [Paper Weight].
- The thickness of available coated paper for each tray is as follows. You cannot load coated paper into the other paper trays.
 - Bypass tray: 73.3–360.0 g/m² (19.6 lb. Bond–198.0 lb. Index)
 - Wide LCT: 73.3–360.0 g/m² (19.6 lb. Bond–198.0 lb. Index)
- When loading coated paper or glossy paper, always fan the paper before using it.
- If a paper jam occurs or if the machine makes a strange noise when feeding stacks of coated paper, feed the coated paper from the bypass tray one sheet at a time.

Thick paper

This section gives you various details about and recommendations concerning thick paper.

When loading thick paper of 127.5–360.0 g/m² (47.0 lb. Cover–198.0 lb. Index), follow the recommendations below to prevent misfeeds and loss of image quality.

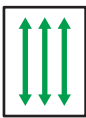
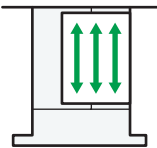
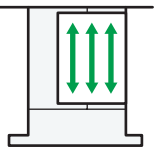
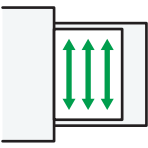
- When loading paper in the paper trays, be sure to load at least 20 sheets. Also, be sure to position the side fences flush against the paper stack.
- When printing on thick smooth paper, be sure to fan the paper thoroughly before loading it. Even if you fan the paper, it may start to stick together again gradually, and paper jams and misfeeds may result. If paper continues to become jammed or feed in together even after they are fanned, load them one by one from the bypass tray.
- When loading thick paper, set the paper direction according to its grain, as shown in the following diagram:

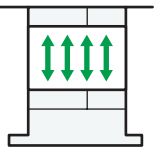
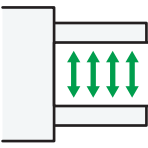
Direction of paper grain	Tray 1 or LCT	Trays 2–3	Bypass tray or wide LCT
			
	Not recommended		

Note

- Select the appropriate paper thickness under Paper Weight as the paper thickness for the tray in [Tray Paper Settings].
- Even if thick paper is loaded as described above, normal operations and print quality might still not be possible, depending on the paper type.
- Prints might have prominent vertical creases.
- Prints might be noticeably curled. Flatten out prints if they are creased or curled.

Envelopes

This section gives you various details about and recommendations concerning envelopes.





Important

- Do not use window envelopes.
- Fan the envelopes before loading them. Otherwise, the envelopes may stick together because of the glue on them. If fanning does not prevent them sticking together, load them one by one. Note that some types of envelopes cannot be used with this machine.
- Misfeeds might occur depending on the length and shape of the flaps.
- When loading envelopes in the  orientation, load them with flaps fully open. Otherwise, they might not feed into the machine.
- Before loading envelopes, press down on them to remove any air from inside, flatten out all four edges. If they are bent or curled, flatten their leading edges (the edge going into the machine) by running a pencil or ruler across them.

In copier mode

The way to load envelopes varies depending on the orientation of the envelopes. When copying onto envelopes, load them according to the applicable orientation shown below:

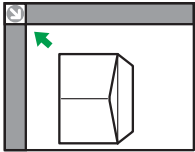
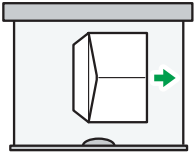
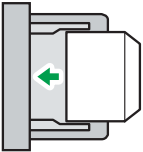
How to load envelopes

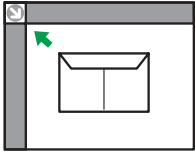
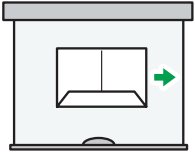
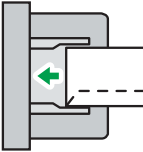



Orientation of envelopes	Exposure glass	Trays 2-3	Bypass tray or wide LCT
<p>Side-opening envelopes </p> 	 <ul style="list-style-type: none"> • Flaps: open • Bottom side of envelopes: toward the left of the machine • Side to be scanned: face down 	 <ul style="list-style-type: none"> • Flaps: open • Bottom side of envelopes: toward the right of the machine • Side to be printed: face down 	 <ul style="list-style-type: none"> • Flaps: open • Bottom side of envelopes: toward the left of the machine • Side to be printed: face up
<p>Side-opening envelopes </p> 	 <ul style="list-style-type: none"> • Flaps: closed • Bottom side of envelopes: toward the front of the machine • Side to be scanned: face down 	 <ul style="list-style-type: none"> • Flaps: closed • Bottom side of envelopes: toward the back of the machine • Side to be printed: face down 	 <ul style="list-style-type: none"> • Flaps: closed • Bottom side of envelopes: toward the back of the machine • Side to be printed: face up

When loading envelopes, specify the envelope size and thickness. For details, see "Copying onto Envelopes", Copy/ Document Server.

In printer mode

The way to load envelopes varies depending on the orientation of the envelopes. When printing onto envelopes, load them according to the applicable orientation shown below:

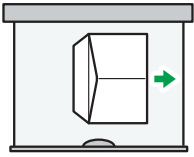
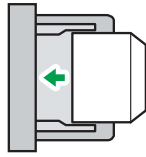
How to load envelopes

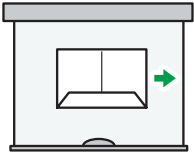
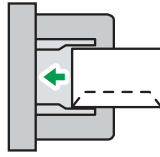
Types of envelopes	Trays 2–3	Bypass tray or wide LCT
Side-opening envelopes  	 <ul style="list-style-type: none"> • Flaps: open • Bottom side of envelopes: toward the right of the machine • Side to be printed: face down 	 <ul style="list-style-type: none"> • Flaps: open • Bottom side of envelopes: toward the left of the machine • Side to be printed: face up
Side-opening envelopes  	 <ul style="list-style-type: none"> • Flaps: closed • Bottom side of envelopes: toward the back of the machine • Side to be printed: face down 	 <ul style="list-style-type: none"> • Flaps: closed • Bottom side of envelopes: toward the back of the machine • Side to be printed: face up

When loading envelopes, select "Envelope" as the paper types using both [Tray Paper Settings] and printer driver and specify the thickness of envelopes. For details, see page 125 "Printing on Envelopes".

Rotate the print image by 180 degrees using the printer driver when printing on the following paper:

- Envelopes that are loaded with their short edges against the machine body
- Envelopes that are loaded with their long edges against the machine body in the bypass tray and wide LCT

Recommended envelopes

For information about recommended envelopes, contact your local dealer.

For details about the sizes of envelopes you can load, see page 189 "Recommended Paper Sizes and Types".

Note

- It is recommended to place one sheet at a time.

- Load only one size and type of envelope at a time.
- The Duplex function cannot be used with envelopes.
- To get better output quality, it is recommended that you set the margins of the four sides, to at least the following values:
 - Leading edge: 4 mm (0.16 inches)
 - Trailing edge: 4 mm (0.16 inches)
 - Right/Left edge: 2 mm (0.08 inches)
- Output quality on envelopes may be uneven if parts of an envelope have differing thicknesses. Print one or two envelopes to check print quality.
- Flatten out prints if they are creased or curled.
- Check the envelopes are not damp.
- High temperature and high humidity conditions can reduce print quality and cause envelopes to become creased.
- Depending on the environment, copying or printing on envelopes may wrinkle them even if they are recommended.
- Certain types of envelopes might come out creased, dirtied, or misprinted. If you are printing a solid color on an envelope, lines may appear where the overlapped edges of the envelope make it thicker.

Registering a Custom Paper with the Media Identification Unit

When you scan paper with the Media Identification Unit, the Media Identification Unit searches custom paper in the master library. When custom paper with configurations that are similar to those of the scanned paper is found, it is displayed.

Part Names and Functions of the Media Identification Unit

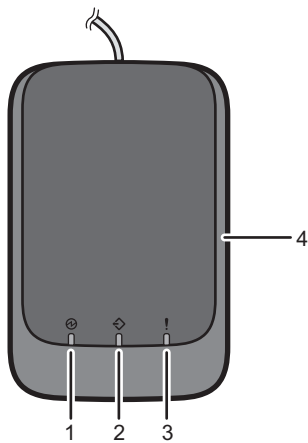

DFZ012

1. Power lamp

Lights up when a USB cable is connected and the Media Identification Unit is ready to start scanning paper.

2. Scanning lamp

Lights up when paper is inserted into the scanning area.

After the paper is removed, it flashes while paper is being scanned.

3. Error lamp

Lights up when an error occurs.

4. Paper scanning area

Insert the paper you want to scan here.

Connect the Media Identification Unit

1. Connect the USB cable to the media slot on the control panel or to the USB host interface on the back of the machine.
 - When using the standard operation panel

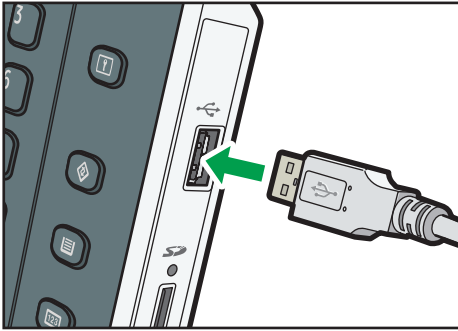

DRC806

- USB host interface

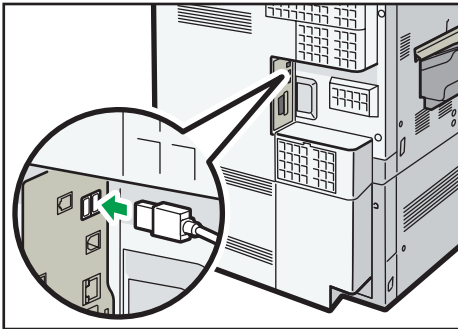

DRC807

8

How to Register Paper Scanned by the Media Identification Unit as Custom Paper

Registering a paper from the master library with the Media Identification Unit

1. Display the [Tray Paper Settings] screen.
 - When using the standard operation panel
 1. Press the [Paper Setting] key.

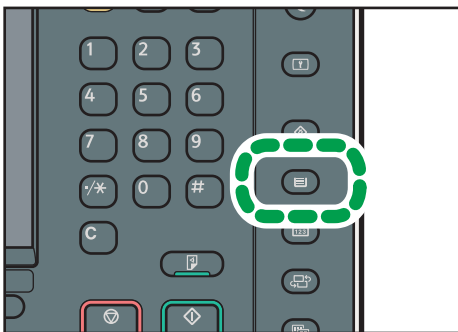

DRC135

- When using the Smart Operation Panel
 1. Press [Home] (🏠) at the bottom of the screen in the center.
 2. Press the [User Tools] icon (⚙️) on the [Home] screen.
 3. Press [Tray Paper Settings].
- 2. Press [Edit Custom Paper].**
- 3. Press [Import from Master Library].**
- 4. Press [Paper Type Auto Identification].**

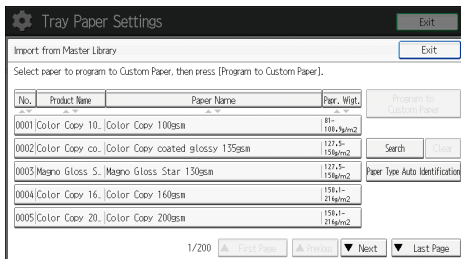

- 5. Insert paper into the Media Identification Unit, and then remove it.**
 Hold the edges of the paper with both hands when inserting the paper.
 Keep the paper flat as you pull it out.

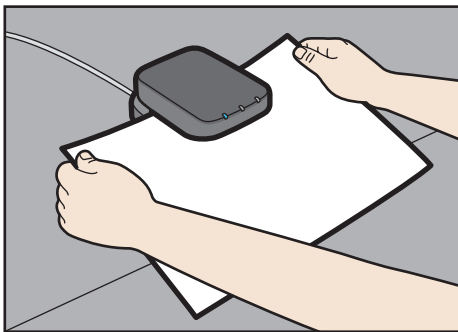

DFZ009

The list of custom paper whose configurations are similar to those of the scanned paper appears.

- 6. Select the custom paper you want to use, and then press [OK].**
- 7. Press [Yes].**
- 8. Press [Exit] twice.**
- 9. Close the [Tray Paper Settings] screen.**
 - When using the standard operation panel
 1. Press the [Paper Setting] key.
 - When using the Smart Operation Panel
 1. Press [User Tools] (⚙️) on the top right of the screen.

↓ Note

- The list displayed in Step 5 includes custom paper with configurations whose match rates are 80% or higher.
- You can check and change the settings of the registered custom paper such as the paper size setting on the [Edit Custom Paper] screen. For details about modifying the custom paper, see "Modifying a Custom Paper", Paper Settings.

Registering a new custom paper with the Media Identification Unit

1. Display the [Tray Paper Settings] screen.

- When using the standard operation panel
 1. Press the [Paper Setting] key.

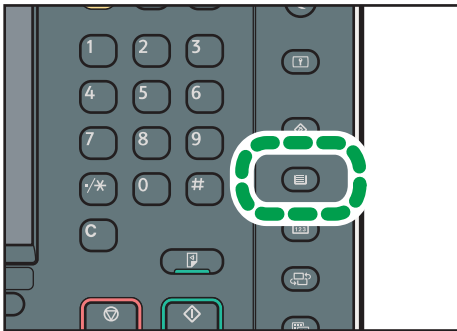

DRC135

- When using the Smart Operation Panel
 1. Press [Home] (🏠) at the bottom of the screen in the center.
 2. Press the [User Tools] icon (⚙️) on the [Home] screen.
 3. Press [Tray Paper Settings].

2. Press [Edit Custom Paper].

3. Press [New Program].

4. Press [Scan Value to Program with Media Identification Unit].

5. Insert paper into the Media Identification Unit, and then remove it.

Hold the edges of the paper with both hands when inserting the paper.

Keep the paper flat as you pull it out.

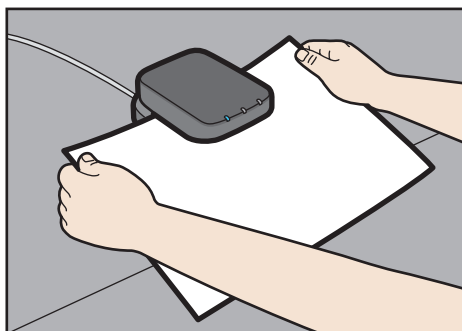

DFZ009

6. Change the settings for custom paper (such as paper's name, size, and type), as necessary.

If you change the [Paper Weight], [Paper Type], [Coated Paper Type], [Paper Color], [Prepunched or Not], or [Textured or Not] and press [OK], a message appears to notify you that the [Advanced Settings] will be initialized. To apply the changes for those settings, select [Change]. To cancel the changes, select [Do not Change].

7. Press [OK].

8. Press [Exit].

9. Close the [Tray Paper Settings] screen.

- When using the standard operation panel
 1. Press the [Paper Setting] key.
- When using the Smart Operation Panel
 1. Press [User Tools] (⚙️) on the top right of the screen.

↓ Note

- When you register and scan custom paper using the Media Identification Unit, following items are automatically specified:
 - Paper weight
 - Coated paper other than matte paper
- For details about custom paper settings, see "Custom Paper Settings", Paper Settings.
- For details about [Advanced Settings], contact your machine administrator.

Modifying the registered custom paper settings using the Media Identification Unit

1. Display the [Tray Paper Settings] screen.

- When using the standard operation panel
 1. Press the [Paper Setting] key.

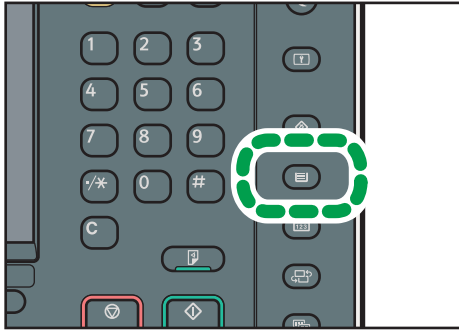

DRC135

- When using the Smart Operation Panel
 1. Press [Home] (🏠) at the bottom of the screen in the center.
 2. Press the [User Tools] icon (⚙️) on the [Home] screen.
 3. Press [Tray Paper Settings].

2. Press [Edit Custom Paper].

3. Select the custom paper whose settings you want to modify.

Press [▲Previous] or [▼Next] to scroll through the list to find the paper that you want to modify.

4. Press [Scan Value to Program with Media Identification Unit].

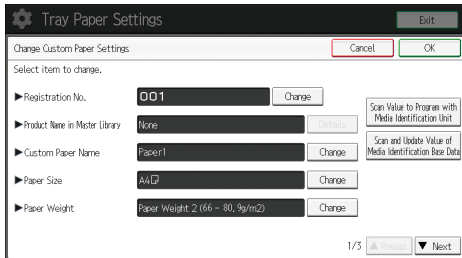

5. Insert paper into the Media Identification Unit, and then remove it.

Hold the edges of the paper with both hands when inserting the paper.

Keep the paper flat as you pull it out.

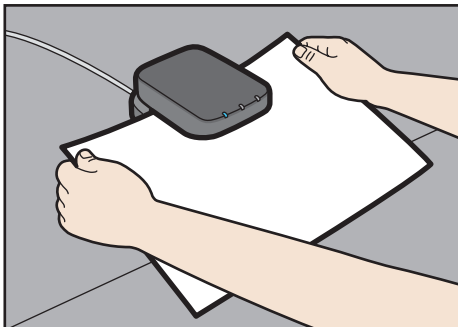

DFZ009

6. Change the settings.

If you change the [Paper Weight], [Paper Type], [Coated Paper Type], [Paper Color], [Prepunched or Not], or [Textured or Not] and press [OK], a message appears to notify you that the [Advanced Settings] will be initialized. To apply the changes for those settings, select [Change]. To cancel the changes, select [Do not Change].

7. Press [OK].**8. Press [Overwrite].**

Press [Save] to register the paper settings as another custom paper.

9. Press [Yes].**10. Press [Exit].****11. Close the [Tray Paper Settings] screen.**

- When using the standard operation panel
 1. Press the [Paper Setting] key.
- When using the Smart Operation Panel
 1. Press [User Tools] () on the top right of the screen.

Note

- For details about custom paper settings, see "Custom Paper Settings", Paper Settings.
- You cannot modify a custom paper that is assigned to a paper tray. To modify it, cancel the assignment.
- For details about [Advanced Settings], contact your machine administrator.
- Sheets of custom paper are assigned with a sequential number from 0001. You can change the number on the [Change Custom Paper Settings] screen.
- Press [Scan and Update Value of Media Identification Base Data] to register the information scanned by the Media Identification Unit. Also press this button to increase identification accuracy to search for custom paper or register information from custom paper that was registered without using the master library.

Specifying a custom paper for paper trays with the Media Identification Unit

1. Display the [Tray Paper Settings] screen.

- When using the standard operation panel
 1. Press the [Paper Setting] key.

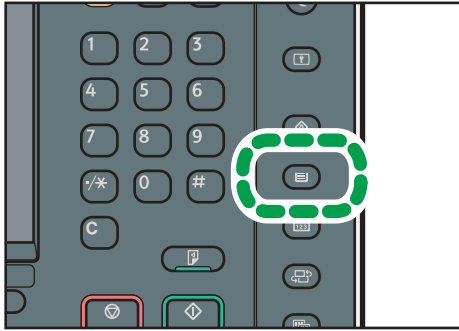

DRC135

- When using the Smart Operation Panel
 1. Press [Home] (🏠) at the bottom of the screen in the center.
 2. Press the [User Tools] icon (⚙️) on the [Home] screen.
 3. Press [Tray Paper Settings].

2. Select the number of the tray whose paper settings you want to specify.
3. Press [Paper Type Auto Identification].

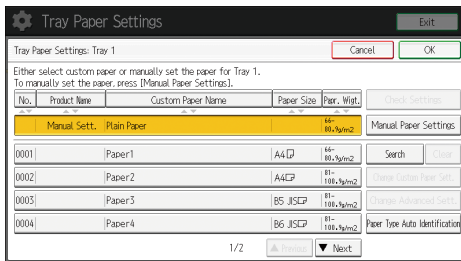

4. Insert paper into the Media Identification Unit, and then remove it.

Hold the edges of the paper with both hands when inserting the paper.

Keep the paper flat as you pull it out.

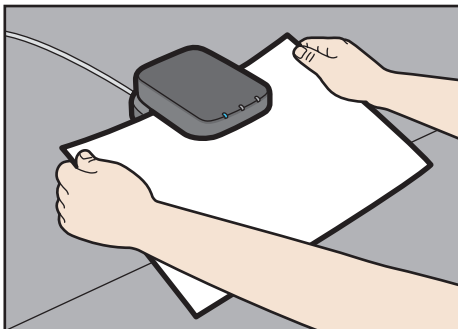

DFZ009

The list of custom paper whose configurations are similar to those of the scanned paper appears.

5. Select the custom paper you want to use, and then press [OK].

The custom papers that can be used in the selected tray appear.

Press [▲Previous] or [▼Next] to scroll through the list to find a paper that you want to select.

After selecting a custom paper, you can check its type and color by pressing Check Settings.

6. Close the [Tray Paper Settings] screen.

- When using the standard operation panel
 1. Press the [Paper Setting] key.
- When using the Smart Operation Panel
 1. Press [User Tools] () on the top right of the screen.

Note

- If you want to change the custom paper settings, press [Change Custom Paper Sett.] in Step 3.

Adding Toner

This section explains precautions when adding toner, how to send scanned documents when the toner has run out, and how to dispose of used toner.

WARNING

- Do not incinerate toner (new or used) or toner containers. Doing so risks burns. Toner will ignite on contact with naked flame.

- Do not store toner (new or used) or toner containers anywhere near naked flames. Doing so risks fire and burns. Toner will ignite on contact with naked flame.

- Do not use a vacuum cleaner to remove spilled toner (including used toner). Absorbed toner may cause a fire or explosion due to electrical contact flickering inside the vacuum cleaner. However, it is possible to use a vacuum cleaner that is explosion-proof and dust ignition-proof. If toner is spilled on the floor, remove the spilled toner slowly using a wet cloth, so that the toner is not scattered.

CAUTION

- Do not crush or squeeze toner containers. Doing so can cause toner spillage, possibly resulting in dirtying of skin, clothing, and floor, and accidental ingestion.

- Store toner (new or used), toner containers, and components that have been in contact with toner out of reach of children.

- If toner or used toner is inhaled, gargle with plenty of water and move into a fresh air environment. Consult a doctor if necessary.

- If toner or used toner gets into your eyes, flush immediately with large amounts of water. Consult a doctor if necessary.

- If toner or used toner is swallowed, dilute by drinking a large amount of water. Consult a doctor if necessary.

- When removing jammed paper or replacing toner, avoid getting toner (new or used) on your clothing. If toner comes into contact with your clothing, wash the stained area with cold water. Hot water will set the toner into the fabric and make removing the stain impossible.

- When removing jammed paper or replacing toner, avoid getting toner (new or used) on your skin. If toner comes into contact with your skin, wash the affected area thoroughly with soap and water.

⚠ CAUTION

- When replacing a toner or waste toner container or consumables with toner, make sure that the toner does not splatter. Put the waste consumables in a bag after they are removed. For consumables with a lid, make sure that the lid is shut.



★ Important

- Always replace the toner cartridge when a notification appears on the machine.
- Fault may occur if you use toner other than the recommended type.
- When adding toner, do not turn off the main power. If you do, settings will be lost.
- Store toner where it will not be exposed to direct sunlight, temperatures above 35°C (95°F), or high humidity.
- Place the toner cartridge on a flat surface with its opening facing up.
- Do not shake the toner cartridge with its mouth down after removing it. Residual toner may scatter.
- Do not repeatedly install and remove toner cartridges. This will result in toner leakage.

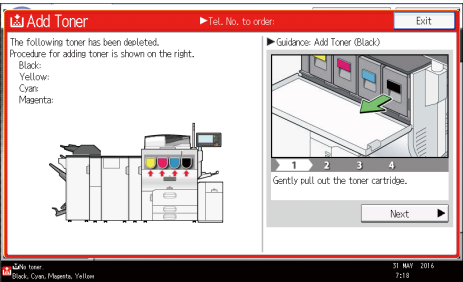
Follow the instruction on the screen regarding how to replace a toner cartridge.



↓ Note

- If "Toner Cartridge is almost empty." appears, the toner has almost run out. Have a replacement toner cartridge at hand.
- If  appears when there is a lot of toner, follow the toner replacement instructions that appear on the screen. Pull out the cartridge, and then reinstall it.
- When you use the standard operation panel, you can check the name of the required toner and the replacement procedure using the [Add Toner] screen.
- When you use the Smart Operation Panel, you can check the name of the required toner and the replacement procedure using the [Add Toner] screen. To display the [Add Toner] screen, press [Check Status], and then press [Check] in the [Mach. Status] area in the [Mach./Applic. Stat] tab.
- For details about how to check contact number where you can order supplies, see "Inquiry", Maintenance and Specifications.

Sending scanned documents when toner has run out

When the machine has run out of toner, the indicator on the display lights. Note that even if there is no toner left, you can still send scanned documents.

1. Display the initial scanner screen.

- When using the standard operation panel
 1. Press the [Home] key on the bottom left of the control panel.

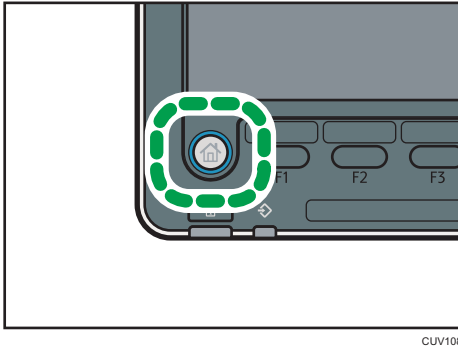

2. Press the [Scanner] icon on the [Home] screen.

If the [Scanner] icon does not appear, press the  icon at the upper right corner of the screen to switch to the menu screen.

- When using the Smart Operation Panel
 1. Press [Home] () at the bottom of the screen in the center.
 2. Press the [Scanner] icon on the [Home] screen.

2. Press [Exit], and then perform transmission operation.

The error message disappears.

Note

- Any reports are not printed.

Disposing of used toner

This section describes what to do with used toner.

Toner cannot be re-used.

Pack used toner containers in the container's box or a bag to prevent the toner from leaking out of the container when you dispose of it.

 **Region A** (mainly Europe)

If you want to discard your used toner container, please contact your local sales office. If you discard it by yourself, treat it as general plastic waste material.

 **Region B** (mainly North America)

Please see our local company website for information on the recycling of supply products, or you can recycle items according to the requirements of your local municipalities or private recyclers.

Menu Items and Functions

All items in Adjustment Settings for Operators appear regardless of which of the machine's optional components are installed. If you change the settings of options that are not installed, the changes will have no effect.

Machine: Image Quality

For details about the following items, see "Machine: Image Quality", Paper Settings.

No.	Item	Description
0209	Photoconductor Special Mode	Increase the amount of lubricant applied to the photoconductor.
0210	Smooth Fusing Belt	Remove vertical and horizontal lines from printouts.
0211	Fusing Ability by Paper Feed Speed	Increase fusing performance.
0214	Fusing Belt Smoothing Setting: Uneven Gloss	Specify whether or not to automatically execute [For Uneven Gloss (Short Time)] for smooth fusing belt.

Machine: Paper Feed/ Output

For details about the following items, see "Machine: Paper Feed/ Output", Paper Settings.

No.	Item	Description
0106	Criteria for Paper Weight	The machine may fail to correctly detect the weight of the paper loaded in the paper tray. If this happens, adjust the machine so the printing conditions are suitable by inputting a numerical value (um) for the thickness of the paper.

Machine: Maintenance

For details about the following items, see "Machine: Maintenance", Paper Settings.

No.	Item	Description
0309	Execute Developer Refreshing	The machine uses degraded toner in the development unit and adds new toner from the toner bottle.
0702	Temperature / Humidity outside the Machine	Display the external temperature and humidity.

No.	Item	Description
0703	Back Up / Restore Custom Paper Data	Back up and restore custom paper profiles.

Finishing: Finisher

For details about the following items, see "Finishing: Finisher", Paper Settings.

No.	Item	Description
0401	Adjust Punch Position With Feed Direction	Adjust the horizontal position of the punch holes when using Finisher SR4120 or Booklet Finisher SR4130.
0402	Adjust Punch Position Across Feed Direction	Adjust the vertical position of the punch holes when using Finisher SR4120 or Booklet Finisher SR4130.
0403	Adjust Staple Position	Adjust the vertical position of the staples when using Finisher SR4120 or Booklet Finisher SR4130.
0404	Adjust Staple Position for Booklet	Adjust the horizontal position of the booklet staples when using Booklet Finisher SR4130.
0405	Adjust Folding Position for Booklet	Adjust the horizontal position of the folding when using Booklet Finisher SR4130.
0406	Adjust Folding Speed for Booklet	Adjust the folding speed for booklets when using the Booklet Finisher SR4130.
0801	Adjust Staple Position Across Feed Direction 1	Adjust the vertical position of the staple (applied at an edge) when using Finisher SR5070 or Booklet Finisher SR5080.
0802	Adjust Staple Position Across Feed Direction 2	Adjust the vertical position of the staples (dual) when using Finisher SR5070 or Booklet Finisher SR5080.
0803	Adjust Staple Position With Feed Direction	Adjust the horizontal position of the staples when using Finisher SR5070 or Booklet Finisher SR5080.
0807	Adjust Punch Position Across Feed Direction	Adjust the vertical position of the punch holes when using Finisher SR5070 or Booklet Finisher SR5080.
0808	Adjust Punch Position With Feed Direction	Adjust the horizontal position of the punch holes when using Finisher SR5070 or Booklet Finisher SR5080.
0818	Adjust Staple Position for Booklet	Adjust the horizontal position of the booklet staples when using Booklet Finisher SR5080.

No.	Item	Description
0819	Adjust Folding Position for Booklet	Adjust the horizontal position of the folding when using Booklet Finisher SR5080.
0821	Set Number of Folds for Booklet	Specify the number of booklet folds to be performed when using Booklet Finisher SR5080.

Finishing: Fold

For details about the following items, see "Finishing: Fold", Paper Settings.

When using custom paper, settings for [Z-fold Position 1] or [Z-fold Position 2] in the [Advanced Settings] for custom paper are prioritized.







No.	Item	Description
0608	Z-fold Position 1	Adjust the width of the bottom end segment of Z-folded sheets when using the multi-folding unit.
0609	Z-fold Position 2	Adjust the overall fold size of Z-fold sheets when using the multi-folding unit.



9. Troubleshooting

This chapter describes basic troubleshooting procedures.

When a Status Icon Is Displayed

This section describes the status icons displayed when the machine requires the user to remove misfed paper, to add paper, or to perform other procedures.

Status Icon	Status
 : Paper Misfeed icon	Appears when a paper misfeed occurs. For details about removing jammed paper, see "Removing Jammed Paper", Troubleshooting.
 : Original Misfeed icon	Appears when an original misfeed occurs. For details about removing jammed paper, see "Removing Jammed Paper", Troubleshooting.
 : Load Paper icon	Appears when paper runs out. For details about loading paper, see "Loading Paper", Paper Specifications and Adding Paper.
 : Add Toner icon	Appears when toner runs out. For details about adding toner, see "Adding Toner", Maintenance and Specifications.
 : Add Staple icon	Appears when staples run out. For details about adding staples, see "Adding Staples", Maintenance and Specifications.
 : Waste Toner Full icon	Appears when the waste toner bottle is full. For details about replacing the waste toner bottle, see "Replacing the Waste Toner Bottle", Maintenance and Specifications.
 : Hole Punch Receptacle Full icon	Appears when the hole punch receptacle is full. For details about removing punch waste, see "Removing Punch Waste", Troubleshooting.

Status Icon	Status
 : Waste Staple Full icon	Appears when the waste staple receptacle is full. For details about removing staple waste, see "Removing Staple Waste", Troubleshooting.
 : Service Call icon	Appears when the machine is malfunctioning or requires maintenance.
 : Open Cover icon	Appears when one or more covers of the machine are open.

When the Indicator Lamp for the [Check Status] Key Is Lit or Flashing

If the indicator lamp for the [Check Status] key lights up or flashes, press the [Check Status] key to display the [Check Status] screen. Check the status of each function in the [Check Status] screen.

[Check Status] screen when using the standard operation panel

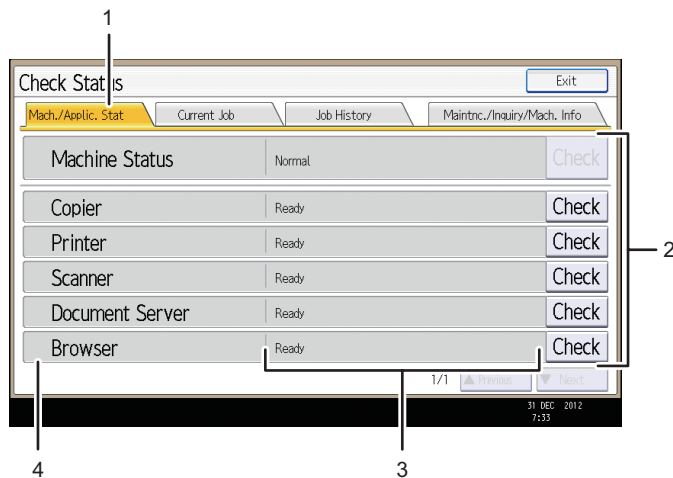

CUR013

1. [Mach./Applic. Stat] tab

Indicates the status of the machine and each function.

2. [Check]

If an error occurs in the machine or a function, press [Check] to view details.

Pressing [Check] displays an error message or the corresponding function screen. Check the error message displayed on the function screen and take the appropriate action. For details about how to resolve the problems described in error messages, see "When Messages Appear", Troubleshooting.

3. Messages

Displays a message that indicates the status of the machine and each function.

4. Status icons

The status icons that can be displayed are described below:

: The function is performing a job.

: The machine cannot be used because an error has occurred in the machine.

: The function cannot be used because an error has occurred in the function or machine. This icon may also appear if the toner is running low.

[Check Status] screen when using the smart operation panel

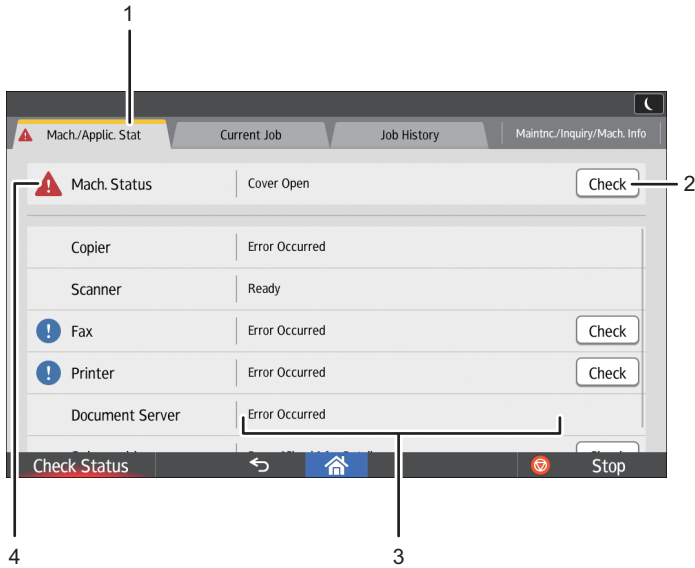

DRC641

1. [Mach./Applic. Stat] tab

Indicates the status of the machine and each function.

2. [Check]

If an error occurs in the machine or a function, press [Check] to view details.

Pressing [Check] displays an error message or the corresponding function screen. Check the error message displayed on the function screen and take the appropriate action. For details about how to resolve the problems described in error messages, see "When Messages Appear", Troubleshooting.

3. Messages

Displays a message that indicates the status of the machine and each function.

4. Status icons

The status icons that can be displayed are described below:

: The function is performing a job.

: The machine cannot be used because an error has occurred in the machine.

: The function cannot be used because an error has occurred in the function or machine. This icon may also appear if the toner is running low.

The following table explains problems that cause the indicator lamp for the [Check Status] key to light or flash.

Problem	Cause	Solution
Documents and reports do not print out.	The paper output tray is full.	Remove the prints from the tray.

Problem	Cause	Solution
Documents and reports do not print out.	There is no paper left.	Load paper. For details about loading paper, see "Loading Paper", Paper Specifications and Adding Paper.
An error has occurred.	A function which has the status "Error Occurred" in the [Check Status] screen is defective.	Press [Check] in the function which the error has occurred. Then read the displayed message, and take the appropriate action. For details about error messages and their solutions, see "When Messages Appear", Troubleshooting. You can use other functions normally.
The machine is unable to connect to the network.	A network error has occurred.	<ul style="list-style-type: none"> • Check that the machine is correctly connected to the network and that the machine is correctly set. For details about how to connect the network, see "Connecting to the Interface", Connecting the Machine/ System Settings. • For details about connecting to the network, contact your administrator. • If the indicator lamp is still lit even after you try to solve the problem as described here, contact your service representative.

When the Machine Makes a Beeping Sound

The following table describes the meaning of the various beep patterns that the machine issues to alert users about left originals and other machine conditions.

Beep pattern	Meaning	Cause
Single short beep	Panel/screen input accepted.	A screen key was pressed.
Short, then long beep	Panel/screen input rejected.	An invalid key was pressed on the screen, or the entered password was incorrect.
Single long beep	Job completed successfully.	A Copier/Document Server Features job has finished.
2 long beeps	Machine has warmed up.	When the power is turned on or the machine exits Sleep mode, the machine has fully warmed up and is ready for use.
5 long beeps	Soft alert	An auto reset was performed through the simple screen of the Copier/Document Server function or the Scanner function.
5 long beeps repeated four times.	Soft alert	An original has been left on the exposure glass or paper tray is empty.
5 short beeps repeated five times.	Strong alert	The machine requires user attention because paper has jammed, the toner needs replenishing, or other problems have occurred.

↓ Note

- Users cannot mute the machine's beep alerts. When the machine beeps to alert users of a paper jam or toner request, if the machine's covers are opened and closed repeatedly within a short space of time, the beep alert might continue, even after normal status has resumed.
- You can enable or disable beep alerts. For details about Sound, see "DEVICE", Connecting the Machine/ System Settings.

When You Have Problems Operating the Machine

Problem	Cause	Solution
When the machine is turned on, the only icon that appears on the home screen is the copier function icon.	Functions other than the copier function are not yet ready.	Wait a little longer.
The machine has just been turned on and the User Tools screen is displayed, but the User Tools menu has items missing.	Functions other than the copier function are not yet ready. Time required varies by function. Functions appear in the User Tools menu when they become ready for use.	Wait a little longer.
The indicator lamp remains lit and the machine does not enter Sleep mode even though the [Energy Saver] key was pressed.	In some cases, the machine does not enter Sleep mode when the [Energy Saver] key is pressed.	Before you press the [Energy Saver] key, check that Sleep mode can be enabled. For details about enabling Sleep mode, see "Saving Energy", Getting Started.
The display is turned off.	The machine is in Low Power mode.	<p>When using the standard operation panel</p> <p>Touch the display panel or press one of the keys on the control panel to cancel Low Power mode.</p> <p>When using the Smart Operation Panel</p> <p>Touch the display panel.</p>
The display is turned off.	The machine is in Sleep mode.	<p>When using the standard operation panel</p> <p>Press the [Energy Saver] key or the [Check Status] key to exit Sleep mode.</p> <p>When using the Smart Operation Panel</p> <p>Touch the display panel.</p>

Problem	Cause	Solution
<p>When using the standard operation panel</p> <p>Nothing happens when the [Check Status] key or the [Energy Saver] key is pressed.</p> <p>When using the Smart Operation Panel</p> <p>Nothing happens when the display panel is touched.</p>	The power is turned off.	Make sure the main power indicator is off, and then turn on the power.
The power turns off automatically.	The Weekly Timer setting is set to [Main Power Off].	Change the Weekly Timer setting. For details about the Weekly Timer setting, see "Timer Settings", Connecting the Machine/ System Settings.
The user code entry screen is displayed.	Users are restricted by User Code Authentication.	For details about how to log in when User Code Authentication is enabled, see "When the Authentication Screen is Displayed", Getting Started.
The Authentication screen appears.	User Authentication is set.	See "When the Authentication Screen is Displayed", Getting Started.
An error message is still displayed, even if misfed paper is removed.	Paper is still jammed in the tray.	Remove the jammed paper by following the procedures displayed on the control panel. For details about removing jammed paper, see "Removing Jammed Paper", Troubleshooting.
An error message is still displayed, even if the indicated cover is closed.	One or more of the covers that are not indicated are still open.	Close all the covers of the machine.
Images are printed on the reverse side of the paper.	You may have loaded the paper incorrectly.	Load the paper correctly. For details about loading paper, see "Loading Paper", Paper Specifications and Adding Paper.

Problem	Cause	Solution
Misfeeds occur frequently.	Using curled paper often causes misfeeds, soiled paper edges, or slipped positions while performing staple or stack printing.	<ul style="list-style-type: none"> • Flatten the paper with your hands to straighten out the curl. • Load the paper up side down so that the curled edges face downward. For details about recommended paper, see "Recommended Paper", Paper Specifications and Adding Paper. • Place the cut paper on a flat surface to prevent it from curling, and do not lean it against the wall. For details about the proper way to store paper, see "Paper Storage", Paper Specifications and Adding Paper.
Misfeeds occur frequently.	The tray's side or end fences may not be set properly.	<ul style="list-style-type: none"> • Remove the misfed paper. For details about removing jammed paper, see "Removing Jammed Paper", Troubleshooting. • Check that the side or end fences are set properly. Also, check that the side fences are locked. For details about setting the side and end fences, see "Changing the Paper Size", Paper Specifications and Adding Paper.

Problem	Cause	Solution
Misfeeds occur frequently.	Paper of undetectable size has been loaded.	<ul style="list-style-type: none"> Remove misfed paper. For details about removing jammed paper, see "Removing Jammed Paper", Troubleshooting. If you load a paper size that is not selected automatically, you need to specify the paper size with the control panel. For details about specifying paper size with the control panel, see "Changing to a Size That Is Not Automatically Detected", Paper Specifications and Adding Paper.
Misfeeds occur frequently.	There is a foreign object on the finisher tray.	<ul style="list-style-type: none"> Remove the misfed paper. For details about removing jammed paper, see "Removing Jammed Paper", Troubleshooting. Do not place anything on the finisher tray.
Misfeeds occur frequently.	The staple cartridge is not set correctly.	Set the staple cartridge properly. For details about how to add staples, see "Adding Staples", Maintenance and Specifications.
Misfeeds occur when printing to envelopes.	The envelopes are curled.	<p>Make sure you fully flatten curled envelopes before you load them. Do not stack envelopes over the specified limit for the paper tray.</p> <p>If misfeeds still occur after the envelopes have been flattened, load envelopes on the tray one at a time and print them individually.</p> <p>For details about how to load envelopes, see page 209 "Envelopes".</p>

Problem	Cause	Solution
When printing to envelopes, the envelopes may be fed in together, or the envelopes may not be fed.	The envelopes are curled.	<p>Make sure you fully flatten curled envelopes before you load them. Do not stack envelopes over the specified limit for the paper tray.</p> <p>If misfeeds still occur after the envelopes have been flattened, load envelopes on the tray one at a time and print them individually.</p> <p>For details about how to load envelopes, see page 209 "Envelopes".</p>
Cannot print in duplex mode.	You have selected a paper tray that is not set for duplex printing.	Change the setting for "Apply Duplex" in "Tray Paper Settings" to enable duplex printing for the paper tray. For details about setting "Apply Duplex", see "Tray Paper Settings", Paper Settings.
Cannot print in duplex mode.	You have selected a paper type that cannot be used for duplex printing.	In "Tray Paper Settings", select a paper type that can be used for duplex printing. For details about setting "Paper Type", see "Tray Paper Settings", Paper Settings.
The machine does not turn off in 4 minutes after the main power is turned off.	The machine cannot perform the shutdown procedure.	Repeat the shutdown procedure. If the machine does not turn off, contact your service representative.
An error has occurred when the Address Book is changed from the display panel or Web Image Monitor.	The Address Book cannot be changed while you delete the multiple stored documents.	Wait a while, and then retry the operation.
The Address Book cannot be changed from the display panel.	The Address Book cannot be changed while it is being backed up from Web Image Monitor or other tools running on the computer.	<ul style="list-style-type: none"> • Wait until the Address Book backup is complete, and then try to change the Address Book again. • If an SC997 error occurs, press [Exit].

Problem	Cause	Solution
Cannot use Web Image Monitor to print documents stored in Document Server.	When print volume limits are specified, users cannot print beyond their print volume limit. Print jobs selected by users who have reached their print volume limits will be canceled.	<ul style="list-style-type: none"> • For details about specifying print volume limits, see "Managing Print Volume per User", Security Guide. • To view the status of a print job, see [Print Job History]. In Web Image Monitor, click [Job] on the [Status/Information] menu. And then click [Print Job History] in "Document Server".
The function does not run or cannot be used.	If you cannot carry out your job, it may be that the machine is being used by another function.	<p>Wait until the current job is completed before trying again.</p> <p>For details about Function Compatibility, see page 241 "When Multiple Functions Cannot Be Executed Simultaneously".</p>
The function does not run or cannot be used.	The function cannot be performed while the Address Book is being backed up from Web Image Monitor or other tools running on the computer.	Wait a while. When the Address Book backup is complete, the function will be performed.
Paper is bent.	Paper may be bent when it is ejected from the finisher upper tray.	Change the output tray to the finisher shift tray.
The print image is not properly positioned on the paper.	The machine has not detected the paper type and/or width correctly.	Contact the machine administrator or your service representative.
The print image is not properly positioned on the paper.	The print position is not aligned properly.	Contact the machine administrator or your service representative.

Fold

Problem	Cause	Solution
Wrinkling occurs when gate fold, letter fold-in, or letter fold-out is applied.	Wrinkling can occur if gate fold, letter fold-in, or letter fold-out is applied to B4 JIS ☐, A3☐, 8 1/2" × 14"☐, 11" × 17"☐, 12" × 18"☐, 8 1/2" × 13 2/5"☐, 8 1/2" × 13 2/5"☐, 8K☐, or larger sizes of paper.	When applying gate fold, letter fold-in, or letter fold-out to paper larger than A4, we recommend you enable image reduction and use paper no larger than A4☐.
When you print Z-folded paper, the machine indicates that the output tray is full even though the amount of output paper on the tray is less than the stack capacity.	The Z-fold support tray is not set.	Set the Z-fold support tray for finisher or multi-folding unit. For details about how to add the Z-fold support tray, see "Finishing", Copy/ Document Server.
The multi-folding unit outputs sheets with creased edges when gate fold is applied.	The paper is curled.	Remove the paper, and then reload it upside down. Alternatively, remove the paper, and then reload it in the opposite direction.
The position of the fold is incorrect when letter fold-in is applied to a B5 JIS sheet.	Multi-sheet fold has been specified when only one sheet is being printed.	In [Finishing] on the initial copier screen, under [Folding Unit], select [Letter Fold-in]. Press [Change], and then set "Multi-sheet Fold" to [Off]. For details about how to specify the multi-sheet fold function, see "Finishing", Copy/Document Server.

Note

- There are times when images might not turn out as you want because of paper type, paper size, or paper capacity problems, use the recommended paper. For details about recommended paper, see "Recommended Paper Sizes and Types", Paper Specifications and Adding Paper.

When Multiple Functions Cannot Be Executed Simultaneously

If you cannot carry out your job, it may be that the machine is being used by another function.

Wait until the current job is completed before trying again. In certain cases, you can carry out another job using a different function while the current job is being performed.

For details about Function Compatibility, see "Function Compatibility", Troubleshooting.

Messages Displayed When You Use the Copy/Document Server Function

★ Important

- If you cannot make copies as you want because of the paper type, paper size or paper capacity problems, use recommended paper. For details about recommended paper, see "Recommended Paper Sizes and Types", Paper Specifications and Adding Paper.

Message	Cause	Solution
"Cannot delete the folder because it contains files with passwords. Delete the files with passwords, or please contact the file administrator."	The folder cannot be deleted because it contains a locked original.	Unlock the locked original to delete it. For details about locked files, see "Managing Stored Files", Security Guide.
"Cannot detect original size."	The original placed on the exposure glass is a non-standard size.	<ul style="list-style-type: none"> • Place the original on the exposure glass again. Face the original down. • If the machine cannot detect the size of the original, specify the size manually - do not use Auto Paper Select mode or the Auto Reduce/Enlarge function. For details about specifying the settings, see "Sizes Detectable with Auto Paper Select", Paper Specifications and Adding Paper.
"Cannot detect original size."	Original is not placed, or the original placed on the exposure glass is a non-standard size.	<ul style="list-style-type: none"> • Place the original correctly. • Specify the paper size. • When placing an original directly on the exposure glass, the lifting/lowering action of the ADF triggers the automatic original size detection process. Lift the ADF by 30 degrees or more.

Message	Cause	Solution
"Cannot display preview of this page."	The image data may have been corrupted.	Press [Exit] to display the preview screen without a thumbnail. If the selected document contains several pages, press [Switch] on the "Display Page" area to change the page, and then a preview of the next page will appear.
"Cannot punch this paper size."	The Punch function cannot be used with paper size selected.	For details about paper, see "Specifications for Punch Unit (Finisher SR4120, Booklet Finisher SR4130)" or "Specifications for Punch Unit (Finisher SR5070, Booklet Finisher SR5080)", Maintenance and Specifications.
"Cannot staple paper of this size."	The Staple function cannot be used with paper size selected.	Select a proper paper size. For details about paper, see "Specifications for Finisher SR4120", "Specifications for Booklet Finisher SR4130", "Specifications for Finisher SR5070", or "Specifications for Booklet Finisher SR5080", Maintenance and Specifications.
"Check paper size."	An irregular paper size is set.	If you press the [Start] key, the copy will start using the selected paper.
"Duplex is not available with this paper size."	A paper size not available in Duplex mode has been selected.	Select a proper paper size. For details about paper, see "Specifications for the Main Unit", Maintenance and Specifications.
"Exceeded the maximum number of sheets that can be used. Copying will be stopped."	The number of pages the user is permitted to copy has been exceeded.	For details about how to check the number of copies available per user, see "Managing Print Volume per User", Security Guide.
"Exceeded the maximum number of multi-sheet fold. Printing will be cancelled."	A print job was canceled because more than the maximum number of multi-sheet folds was specified.	Specify fewer sheets for the multi-sheet fold function. For details about the maximum number of multi-sheet fold, see "Fold", Copy/Document Server.

Message	Cause	Solution
"File being stored exceeded max. number of pages per file. Copying will be stopped."	The scanned originals have too many pages to store as one document.	Press [Exit], and then store again with an appropriate number of pages.
"Magazine or Booklet mode is not available due to mixed image mode."	You selected the "Magazine" or "Booklet" function for originals scanned using different functions, such as copy and printer.	Make sure originals for the "Magazine" or "Booklet" function are scanned using the same function.
"Maximum number of sets is n." ("n" is replaced by a variable.)	The number of copies exceeds the maximum copy quantity.	You can change the maximum copy quantity from [Max. Copy Quantity] in [General Features] under [Copier / Document Server Features]. For details about Max. Copy Quantity, see "General Features", Copy/ Document Server.
"Memory is full. nn originals have been scanned. Press [Print] to copy scanned originals. Do not remove remaining originals." ("n" is replaced by a variable.)	The number of scanned originals exceed the number of pages that can be stored in memory.	Press [Print] to copy scanned originals and cancel the scanning data. Press [Clear Memory] to cancel the scanning data and not copy.
"Press [Continue] to scan and copy remaining originals."	The machine checked if the remaining originals should be copied, after the scanned originals were printed.	Remove all copies, and then press [Continue] to continue copying. Press [Stop] to stop copying.
"Rotate Sort is not available with this paper size."	A size of paper for which Rotate Sort is not available is selected.	Select a proper paper size. For details about paper, see "Sort", Copy/ Document Server.

Message	Cause	Solution
"Stapling capacity exceeded."	The number of sheets per set is over the staple capacity.	Check the stapler capacity. For details about the stapler capacity, see "Specifications for Finisher SR4120", "Specifications for Booklet Finisher SR4130", "Specifications for Finisher SR5070", or "Specifications for Booklet Finisher SR5080", Maintenance and Specifications.
"The selected folder is locked. Please contact the file administrator."	An attempt was made to edit or use a locked folder.	For details about locked folders, see "Managing Folders", Security Guide.

↓ Note

- If you set [Memory Full Auto Scan Restart] in [Input / Output] of User Tools to [On], even if the memory becomes full, the memory overflow message will not be displayed. The machine will make copies of the scanned originals first, and then automatically proceed to scan and to copy the remaining originals. In this case, the resulting sorted pages will not be sequential. For details about Memory Full Auto Scan Restart, see "Input / Output", Copy/ Document Server.

When Using the Connect Copy Function

Message	Causes	Solutions
"Cannot connect to the sub-machine. Check the status of the sub-machine."	The  icon is lit. The hard disk of the sub-machine is malfunctioning.	Press [Exit] on the main machine and follow the instructions on the display.
"Cannot print from the sub-machine. Check the status of the sub-machine."	A paper or staple jam has occurred on the sub-machine, or toner or other supplies need to be replaced.	Follow the instructions displayed. For details about adding toner, see "Adding Toner", Maintenance and Specifications. For details about jammed paper or jammed staples, see "Removing Jammed Paper", or "Removing Jammed Staples", Troubleshooting. If the sub-machine's display indicates that a cover is open, follow the instructions displayed.

Message	Causes	Solutions
"Cannot print from the sub-machine. Check the status of the sub-machine."	The sub-machine's User Tools menu is open.	Press the [User Tools] key to close the User Tools menu.
"Cannot print from the sub-machine. Sub-machine will be disconnected."	The sub-machine has stopped due to power failure or communication error.	Continue copying using the main machine.
"Fold is available only when Sort mode is selected in Connect Copy."	Sort has not been selected with fold.	Select the Sort function.
"No stamp data in the sub-machine."	Stamp data on the sub-machine has been deleted.	Reprogram the stamp on the sub-machine.
"Sub-machine does not have the same paper setting(s)."	Paper type or tray settings on the two machines do not match.	Make the same settings on both machines.
"Sub-machine is in Interrupt mode."	The sub-machine is in Interrupt mode.	Press the [Interrupt] key on the sub-machine to cancel Interrupt mode.
"Sub-machine paper settings must be the same to use this tray."	Paper tray settings on the two machines do not match.	Make the same settings on both machines.
"The Cover Sheet setting(s) of the sub-machine is different from the main machine."	Cover Sheet settings on the two machines do not match.	Make the same settings on both machines.
"The Designation Sheet n setting(s) of sub-machine is different from main machine." (<i>"n"</i> in the message represents a changeable number.)	Designation Sheet settings on the two machines do not match.	Make the same settings on both machines.
"The Slip Sheet setting(s) of the sub-machine is different from the main machine."	Slip Sheet settings on the two machines do not match.	Make the same settings on both machines.

Messages Displayed When You Use the Printer Function

This section describes the principal messages that appear on the display panel, error logs or reports. If other messages appear, follow their instructions.

Messages Displayed on the Control Panel When You Use the Printer Function

★ Important

- Before turning off the power, see "Turning On/Off the Power", Getting Started.

Message	Cause	Solution
"Hardware Problem: Ethernet"	An error has occurred in the Ethernet interface.	Turn off the power, and then back on again. If the message appears again, contact your service representative.
"Hardware Problem: HDD"	An error has occurred in the hard disk.	Turn off the power, and then back on again. If the message appears again, contact your service representative.
"Hardware Problem: USB"	An error has occurred in the USB interface.	Turn off the power, and then back on again. If the message appears again, contact your service representative.
"Hardware Problem: Wireless Card" (A "wireless LAN board" is referred to as a "wireless card".)	<ul style="list-style-type: none"> • The wireless LAN board has malfunctioned. • The wireless LAN board you are using is not compatible with this machine. 	Turn off the power, and then confirm the wireless LAN board is inserted correctly. And then, turn on the power again. If the message appears again, contact your service representative.

Message	Cause	Solution
"Load following paper in n. To force print, select another tray and press [Continue]." ("n" is replaced by a variable.)	The printer driver settings are incorrect or the tray does not contain paper of the size selected in the printer driver.	Check that the printer driver settings are correct, and then load paper of the size selected in the printer driver into the input tray. For details about how to change the paper size, see "Changing the Paper Size", Paper Specifications and Adding Paper.
"Paper in staple tray. Open cover and remove paper."	If printing is stopped before it is finished, paper may remain in the finisher.	Remove the paper remaining in the finisher.
"Paper size and type are mismatched. Select another tray from the following and press [Continue]. To cancel job, press [Job Reset]. Paper size and type can also be changed in User Tools."	The printer driver settings are incorrect or the tray does not contain paper of the size or type selected in the printer driver.	<ul style="list-style-type: none"> • Check that the printer driver settings are correct, and then load paper of the size selected in the printer driver into the input tray. For details about how to change the paper size, see "Changing the Paper Size", Paper Specifications and Adding Paper. • Select the tray manually to continue printing, or cancel a print job. For details about how to select the tray manually, or cancel a print job, see "If an Error Occurs with the Specified Paper Size and Type", Print.
"Paper type of n is mismatched. Select another tray from the following and press [Continue]. Paper type can also be changed in User Tools." (A tray name is placed at n.)	The type of the paper in the tray does not match the paper type specified in the printer driver.	Select a tray containing paper that is the same type as the specified paper type.

Message	Cause	Solution
"Parallel I/F board has a problem."	An error has occurred in the IEEE 1284 interface board.	Turn off the power, and then back on again. If the message appears again, contact your service representative.
"Printer font error."	An error has occurred in the font settings.	Contact your service representative.
"Cannot print because both the main and designation (chapter) sheets are set to the same paper tray. Press [Job Reset] to cancel the job. To print the job again specify different trays."	The tray selected for other pages is the same as the one for slip sheets.	Reset the job. Be sure the tray you select for slip sheets is not providing paper for other pages.

When using direct print from a memory storage device

Message	Cause	Solution
"Exceeded the limit value for total data size of the selected files. Cannot select more files."	<ul style="list-style-type: none"> The size of the selected file exceeds 1 GB. The total size of the selected files exceeds 1 GB. 	<p>Files or groups of files larger than 1 GB cannot be printed.</p> <ul style="list-style-type: none"> When the total size of the multiple files that are selected exceeds 1 GB, select files separately. When the size of the selected file exceeds 1 GB, print from a memory storage device using a function other than the Direct printing function. <p>You cannot select files of different formats at the same time.</p>

Message	Cause	Solution
"Unable to access the specified memory storage device."	<ul style="list-style-type: none"> An error occurred when the machine accessed the memory storage device or a file stored on the memory storage device. An error occurred when the user used the Direct printing function to print from a memory storage device. 	Save the file to a different memory storage device, and then print again.

Messages Printed on the Error Logs or Reports When You Use the Printer Function

This section describes likely causes of and possible solutions for the error messages that are printed on the error logs or reports.

When print jobs are canceled

Message	Cause	Solution
"91: Error"	Printing was canceled by the auto job cancel function due to a command error.	Check that the data is valid.
"A function which cannot be used with Fold mode was set. The job has been cancelled."	A print job was canceled because a function(s) not available with Fold was selected.	Cancel the function(s) not available with Fold. For details about the functions not available with Fold, see "Fold", Print.
"A job via the network that was not printed exists because an error occurred. It was stored as a job not printed."	Jobs with errors were stored because an error occurred with a print job via the network while the error job storing function was enabled.	Contact your administrator to check whether the machine is connected correctly to the network. For details about how to check and print jobs stored when print configuration errors occur, see "Printing of Documents Stored When Print Configuration Errors Occur", Print.

Message	Cause	Solution
"Error occurred while processing an Unauthorized Copy Prevention job. Job cancelled."	You tried to store a file in the Document Server when the [Unauthorized Copy Prevention] was specified.	On the printer driver, select a job type other than [Document Server] in "Job Type:" or deselect [Unauthorized Copy Prevention].
"Error occurred while processing an Unauthorized Copy Prevention job. Job cancelled."	The [Enter User Text:] field on the [Unauthorized Copy Prevention for Pattern Details] screen is blank.	On the printer driver's [Detailed Settings] tab, click [Effects] in "Menu:". Select [Unauthorized Copy Prevention], and then click [Details...] to display [Unauthorized Copy Prevention for Pattern Details]. Enter text in [Enter User Text:].
"Error occurred while processing an Unauthorized Copy Prevention job. Job cancelled."	The resolution is set to a value less than 600 dpi when [Unauthorized Copy Prevention] is specified.	On the printer driver, set the resolution to 600 dpi or higher, or cancel [Unauthorized Copy Prevention].
"Error occurred while processing an Unauthorized Copy Prevention job. Job cancelled."	In [Administrator Tools] under [System Settings], priority was specified to be given to Unauthorized Copy Prevention Printing set on this machine.	Cancel Unauthorized Copy Prevention Printing for the printer driver. For details about how to cancel the settings, see the printer driver Help.
"Collate Cancelled"	Collate was canceled.	Turn off the power, and then back on again. If the message appears again, contact your service representative.
"You reach the usage limit. This job has been cancelled."	The number of pages the user is permitted to print has been exceeded.	For details about print volume use limitation, see "Managing Print Volume per User", Security Guide.
"Exceeded the maximum number of multi-sheet fold. The job has been cancelled."	The maximum number of multi-sheet fold was exceeded.	Specify fewer sheets for the multi-sheet fold function. For details about the maximum number of multi-sheet fold, see "Fold", Print.
"Fold is not available with the settings. The job has been cancelled."	Fold function is not available with the current settings.	Check the paper settings. For details about the limitations of the Fold function, see "Fold", Print.
"Receiving data failed."	Data reception was aborted.	Resend the data.

Message	Cause	Solution
"Sending data failed."	The machine received a command to stop transmission from the printer driver.	Check if the computer is working correctly.
"The selected paper size is not supported. This job has been cancelled."	Job reset is automatically performed if the specified paper size is incorrect.	Specify the correct paper size, and then print the file again.
"The selected paper type is not supported. This job has been cancelled."	Job reset is automatically performed if the specified paper type is incorrect.	Specify the correct paper type, and then print the file again.
"Staple error occurred. The job has been cancelled."	The maximum number of sheets that can be stapled together has been exceeded when [Cancel Printing] is selected in [When Exceed Max. No. of Sheets for Booklet] under Printer Features.	Check the number of sheets that are to be stapled together, and try printing again. For details about the number of sheets that can be stapled together, see "Specifications for Finisher SR4120", "Specifications for Booklet Finisher SR4130", "Specifications for Finisher SR5070", or "Specifications for Booklet Finisher SR5080" in Maintenance and Specifications.
"Error occurred while printing job with Background Numbering. Job has been cancelled."	Unprintable paper size was selected, or slip sheet printing was specified when Background Numbering printing was performed.	Check the setting of Background Numbering printing in the printer driver. For details about configuring the printer driver settings, see the printer driver Help. Also note that Background Numbering printing cannot be applied to slip sheets.
"Communication error with central management server has occurred. Job was cancelled."	The job was canceled because a Central Management communication error occurred.	Check the status of the Central Management machine.

Message	Cause	Solution
"All remaining print vol. allocated to other cent. managed client. Job was cancelled."	The job was canceled because the usage count information could not be obtained from the Central Management machines.	All job slots are occupied by other devices. Check the status of the client machine.
"Error occurred while processing a Compulsory Security Stamp job. Job was cancelled."	The job was canceled because an error occurred while applying Compulsory Security Stamp.	When feeding paper from bypass tray, specify the correct paper size (other than [Auto Detect]).

When there is a problem with the print settings

Message	Cause	Solution
"Booklet/Half Fold Error"	The job was canceled because you specified invalid settings for saddle stitching or half fold.	Check the settings for saddle stitching or half fold.
"Classification Code is incorrect."	The classification code has not been entered, or the classification code has been entered incorrectly.	Enter the correct classification code.
"Classification Code is incorrect."	The classification code is not supported with the printer driver.	Select [Optional] for classification code. For details about how to specify classification code settings, see "Configuring Classification Codes", Print.

Message	Cause	Solution
"Duplex Cancelled"	Duplex printing was canceled.	<ul style="list-style-type: none"> • Select the proper paper size for the duplex function. For details about paper, see "Specifications for the Main Unit", Maintenance and Specifications. • Change the setting for "Apply Duplex" in "Tray Paper Settings" to enable duplex printing for the paper tray. For details about setting "Apply Duplex", see "Tray Paper Settings", Paper Settings.
"Exceeded Max. Pages (Collate)"	The number of pages exceeds the maximum number of sheets that you can use Collate with.	Reduce the number of pages to print.
"Exceeded the maximum number of multi-sheet fold (Half Fold)."	The maximum number of multi-sheet folds (Half Fold) was exceeded.	For details about the maximum number of multi-sheet folds (Half Fold), see "Fold", Print.
"Output Tray Changed"	The output tray was changed because the paper size of the specified output tray is limited.	Specify the proper output tray.
"Print Overrun"	Images were discarded while printing.	Select a lower resolution on the printer driver. For details about how to change the resolution setting, see the printer driver Help.
"Punch Cancelled"	Punch printing was canceled.	Check the paper orientation, print orientation, and then punch position. Certain settings can produce print results that might not be as expected.

Message	Cause	Solution
"Staple Cancelled"	Stapling printing was canceled.	Check the paper orientation, paper quantity, print orientation, and staple position. Certain settings can produce print results that might not be as expected.

When documents cannot be stored in the Document Server

Message	Cause	Solution
"Cannot store data of this size."	The paper size exceeded the capacity of the Document Server.	Reduce the paper size of the file that you want to send to a size that the Document Server can store. Custom size files can be sent but not stored afterward.
"Document Server is not available to use. Cannot store."	You cannot use the Document Server function.	For details about using Document Server function, contact your administrator. For details about how to set permissions, see "Limiting Available Functions", Security Guide.
"Exceeded max capacity of document server. Cannot store."	The hard disk became full after a file was stored.	Delete some of the files stored in the Document Server or reduce the size that you want to send.
"Exceeded max number of files of document server. Cannot store."	The maximum file capacity of the Document Server was exceeded.	Delete some of the files stored in the Document Server.
"Exceeded max. number of files. (Auto)"	While you were using the error job store function to store Normal Print jobs as Hold Print files, the maximum file capacity for file storage or Hold Print file management (automatic) was exceeded.	Delete Hold Print files (automatic) or unneeded files stored on the machine.

Message	Cause	Solution
"Exceeded max number of pages of document server. Cannot store."	The maximum page capacity of the Document Server was exceeded.	Delete some of the files stored in the Document Server or reduce the number of pages that you want to send.
"Exceeded max. number of pages. (Auto)"	While you were using the error job store function to store Normal Print jobs as Hold Print files, the maximum page capacity was exceeded.	Delete unneeded files stored on the machine. Reduce the number of pages to print.
"Job cancelled because capture file could not be stored: Exceeded max. memory."	The hard disk became full after a file was stored.	Delete the files stored in the Document Server or reduce the file size to be sent.
"Job cancelled because capture file could not be stored: Exceeded max. files."	The maximum file capacity of the Document Server was exceeded.	Delete the files stored in the Document Server.
"Job cancelled because capture file could not be stored: Exceeded max pages per file."	The maximum page capacity of the Document Server was exceeded.	Delete some of the files stored in the Document Server or reduce the number of pages that you want to send.
"The specified folder in Document Server is locked. Cannot store."	The specified folder is locked.	Unlock the folder or specify another folder number that can be used. For details about locked folders, see "Managing Folders", Security Guide.

When there is not enough free hard disk space

Message	Cause	Solution
"HDD Full"	When you were printing with the PostScript 3 printer driver, the hard disk capacity for fonts and forms was exceeded.	Delete unneeded forms or fonts registered on the machine.

Message	Cause	Solution
"HDD Full"	The hard disk became full while you were printing a Sample Print, Locked Print, Hold Print, or Stored Print file.	Delete unneeded files stored on the machine. Alternatively, reduce the data size of the Sample Print, Locked Print, Hold Print, or Stored Print file.
"HDD is full. (Auto)"	The hard disk became full while you were using the error job store function to store Normal Print jobs as Hold Print files.	Delete unneeded files stored on the machine. Alternatively, reduce the data size of the Temporary Print file and/or the Stored Print file.

When there is not enough memory

Message	Cause	Solution
"84: Error"	There is no work area available for image processing.	Decrease the number of files sent to the machine.
"92: Error"	Printing was canceled because [Job Reset] or the [Stop] key was selected on the machine's control panel.	Perform the print operation again if necessary.

When there is a problem with a parameter

Message	Cause	Solution
"86: Error"	Parameters of the control code are invalid.	Check the print settings.

When the user lacks privileges to perform an operation

Message	Cause	Solution
"No response from the server. Authentication has failed."	A timeout occurred while connection to the server was being established for LDAP authentication or Windows Authentication.	Check the status of the server.
"You do not have a privilege to print this PDF file."	You have no privileges to print the PDF document you tried to print.	Contact the owner of the document.
"You do not have a privilege to use this function. This job has been cancelled."	The entered login user name or login password is not correct.	Check that the user name and password are correct.
"You do not have a privilege to use this function. This job has been cancelled."	The logged in user is not allowed to use the selected function.	For details about how to set permissions, see "Configuring User Authentication", Security Guide.
"You do not have a privilege to use this function. This operation has been cancelled."	The logged in user does not have the privileges to register programs or change the paper tray settings.	For details about how to set permissions, see "Configuring User Authentication", Security Guide.

When a user cannot be registered

Message	Cause	Solution
"Auto-registration of user information has failed."	Automatic registration of information for LDAP Authentication or Windows Authentication failed because the Address Book is full.	For details about automatic registration of user information, see "Auto Registration to the Address Book", Security Guide.

Message	Cause	Solution
"Information for user authentication is already registered for another user."	The user name for LDAP was already registered in a different server with a different ID, and a duplication of the user name occurred due to a switching of domains (servers), etc..	For details about user authentication, see "Configuring User Authentication", Security Guide.

When other errors occur

Message	Cause	Solution
"85: Error"	The specified graphics library is unavailable.	Check that the data is valid.
"98: Error"	The machine could not access the hard disk correctly.	Turn off the power, and then back on again. If the message appears frequently, contact your service representative.
"99: Error"	This data cannot be printed. The specified data is either corrupt or it cannot be printed from a memory storage device using the Direct printing function.	Check that the data is valid. For details about the kinds of data that can be printed from a memory storage device using the Direct printing function, see "Direct Printing from a Memory Storage Device", Print.
"Command Error"	An RPCS command error occurred.	Check using the following procedure: <ul style="list-style-type: none"> • Check if the communication between the computer and the machine is working correctly. • Check if the correct printer driver is being used. • Check if the machine's memory size is set correctly in the printer driver. • Check that the printer driver is the most up-to-date version available.

Message	Cause	Solution
"Compressed Data Error"	The printer detected corrupt compressed data.	<ul style="list-style-type: none"> • Check the connection between the computer and the printer. • Check that the program you used to compress the data is functioning correctly.
"Data Storage Error"	You tried to print a Sample Print, Locked Print, Hold Print, or Stored Print file, or to store a file in the Document Server when the hard disk was malfunctioning.	Contact your service representative.
"Error has occurred."	A syntax error, etc., occurred.	Check that the PDF file is valid.
"Exceeded Max. Stored Files"	While printing a Sample Print, Locked Print, Hold Print, or Stored Print file, the maximum file capacity was exceeded.	Delete unneeded files stored on the machine.
"Exceeded Max. Stored Pages"	While printing a Sample Print, Locked Print, Hold Print, or Stored Print file, the maximum page capacity was exceeded.	Delete unneeded files stored on the machine. Reduce the number of pages to print.
"Failed to obtain file system."	PDF direct printing could not be performed because the file system could not be obtained.	Turn off the power, and then back on again. If the message appears again, contact your service representative.
"File system is full."	PDF file does not print out because the capacity of the file system is full.	Delete all unnecessary files from the hard disk, or decrease the file size sent to the machine.
"Folding Unit Error"	There is a problem with the Multi-Folding Unit.	Contact your service representative.

Message	Cause	Solution
"I/O buffer overflow"	An input buffer overflow occurred.	<ul style="list-style-type: none"> In [Printer Features], under [Host Interface], select [I/O Buffer], and then set the maximum buffer size to a larger value. Reduce the number of files being sent to the machine.
"Insufficient Memory"	A memory allocation error occurred.	<p>PCL 6</p> <p>On the printer driver's [Detailed Settings] tab, click [Print Quality:Advanced] in "Menu:", and then select [Raster] in the "Vector/Raster:" list. In some cases, it will take a long time to complete a print job.</p>
"Memory Retrieval Error"	A memory allocation error occurred.	Turn off the power and then back on again. If the message appears again, replace the RAM. For details about replacing the RAM, contact your service representative.
"Paper Type Error"	The specified paper type name is not set in the machine.	Re-obtain the latest paper type information set in the machine.

If printing does not start, contact your service representative.

Note

- The contents of errors may be printed on the Configuration Page. Check the Configuration Page in conjunction with the error log. For details about how to print the Configuration Page, see "List / Test Print", Print.

Messages Displayed When You Use the Scanner Function

Messages Displayed on the Control Panel When You Use the Scanner Function

This section describes likely causes of and possible solutions for the error messages that appear on the control panel. If a message not described here appears, act according to the message.

Message	Cause	Solution
"Cannot find the specified path. Please check the settings."	The destination computer name or folder name is invalid.	Check whether the computer name and the folder name for the destination are correct.
"Cannot find the specified path. Please check the settings."	An antivirus program or a firewall is preventing the machine from connecting to your computer.	<ul style="list-style-type: none"> • Antivirus programs and firewalls can prevent client computers from establishing connection with this machine. • If you are using antivirus software, add the program to the exclusion list in the application settings. For details about how to add programs to the exclusion list, see the antivirus software Help. • To prevent a firewall from blocking the connection, register the machine's IP address in the firewall's IP address exclusion settings. For details about the procedure for excluding an IP address, see your operating system's Help.
"Entered user code is not correct. Please re-enter."	You have entered an incorrect user code.	Check the authentication settings, and then enter a correct user code.

Message	Cause	Solution
"Exceeded max. number of alphanumeric characters for the path."	The maximum number of specifiable alphanumeric characters in a path has been exceeded.	Check the maximum number of characters which can be entered, and then enter it again. For details about the maximum enterable number of characters, see "Values of Various Set Items for Transmission/Storage Function", Scan.
"Exceeded max. number of alphanumeric characters."	The maximum enterable number of alphanumeric characters has been exceeded.	Check the maximum number of characters which can be entered, and then enter it again. For details about the maximum enterable number of characters, see "Values of Various Set Items for Transmission/Storage Function", Scan.
"Exceeded the maximum number of OCR jobs that can be on standby for storing, please wait. Try again after storing of the current job has completed."	The maximum allowable number of jobs on standby was exceeded because large quantities of documents were stored by the OCR function.	Up to 100 jobs can be placed on standby by the OCR function. Scan the next document after the current jobs have finished being stored.
"File types have been automatically set for some files because multiple files were selected."	If there are selected stored documents which cannot be converted to a specified file format, those documents are automatically converted to a convertible format before they are transmitted.	For details about the file formats used to transmit stored documents, see "Sending a Stored File", Scan.
"Programmed. Cannot program the destination(s) that is not programmed in the address book."	The destinations that were selected while registered to the program contain a folder destination for which one of the following destinations is set: manually entered destination, WSD destination, or DSM destination	WSD destinations and DSM destinations cannot be registered to the program because they cannot be registered in the address book. For manually entered destinations, register the destinations in the address book, and then try to register them to the program again.

Message	Cause	Solution
"Scanner journal is full. Please check Scanner Features."	"Print & Delete Scanner Journal" in [Scanner Features] is set to [Do not Print: Disable Send], and Scanner Journal is full.	Print or delete Scanner Journal. For details about Scanner Features, see "General Settings", Scan.
"The entered file name contains invalid character(s). Enter the file name again using any of the following 1 byte characters. "0 to 9", "A to Z", "a to z", ". - _""	The file name contains a character that cannot be used.	<ul style="list-style-type: none"> Check the file name set at the time of scanning. For details about characters that can be used in file names, see "Specifying the File Name", Scan. Check the file name specified at the time of scanning. The file name specified in the Sending Scan Files to Folders function cannot contain the following characters: $\backslash / : * ? " < >$ The file name cannot start or end with a period ".".
"The program is recalled. Cannot recall the destination(s) for which access privileges are required."	The currently logged-in user does not have permission to view the destination that was registered in the program.	For details about how to set permissions, see "Limiting Available Functions", Security Guide.
"The program is recalled. Cannot recall the destination(s) that is deleted from the address book."	The destination stored in the program could not be recalled because it was deleted from the address book.	Enter the destination directly to send data separately.
"The program is recalled. Cannot recall the folder destination(s) with protection code(s)."	The folder destinations for which the protection code was set were registered in the program.	A destination for which the protection code is set cannot be recalled by the program. Cancel the protection code setting or send scanned files to the destination separately.

When documents cannot be scanned properly

Message	Cause	Solution
"All the pages are detected as blank. No file was created."	No PDF file was created because all the pages of the scanned original were detected as blank when [On] is specified for [Delete Blank Page] in [OCR Settings].	Check whether the original is set upside down. Change [OCR Scanned PDF: Blank Page Sensitivity] in [Scanner Features] to "Sensitivity Level 1".
"Check original's orientation."	Originals may sometimes not be scanned depending on a combination of items such as the specified scaling factor and document size.	Change the orientation of the original, and then scan the original again.
"Exceeded max. data capacity." "Check scanning resolution, then press Start key again."	The scanned data exceeded maximum data capacity.	Specify the scan size and resolution again. Note that it may not be possible to scan very large originals at a high resolution. For details about the settings for the scanner function, see "Relationship between Resolution and Scan Size", Scan.
"Exceeded max. data capacity." "Check the scanning resolution, then reset n original(s)." ("n" in the message represents a variable.)	The scanned original exceeded maximum data capacity.	Specify the scan size and resolution again. Note that it may not be possible to scan very large originals at a high resolution. For details about the settings for the scanner function, see "Relationship between Resolution and Scan Size", Scan.
"Exceeded max. data capacity." "Check the resolution and the ratio and then press the Start key again."	The data being scanned is too large for the scale ratio specified in [Specify Size].	Reduce the resolution or [Specify Size] value, and then scan the original again.

Message	Cause	Solution
"Exceeded max. number of files which can be used in Document Server at the same time."	The maximum number of files that can be stored in the Document Server has been exceeded.	Check the files stored by the other functions, and then delete unneeded files. For details about how to delete files, see "Deleting Stored Documents", Copy/ Document Server.
"Not all of the image will be scanned." "Check the ratio and then press the Start key again."	If the scaling factor specified in "Specify Reproduction Ratio" is too large, part of the image may be lost.	Reduce the scaling factor in "Specify Reproduction Ratio", and then try to scan the original again. If displaying the entire image is not necessary, press the [Start] key to start scanning with the current scaling factor.
"Not all of the image will be scanned." "Check the ratio and then press the Start key again."	Using "Specify Reproduction Ratio" to scale down a large document may cause part of the image to be lost.	Specify a large size in [Specify Size], and then scan the original again. If displaying the entire image is not necessary, press the [Start] key to start scanning with the current scaling factor.
"The size of the scanned data is too small." "Check the resolution and the ratio and then press the Start key again."	The data being scanned is too small for the scale ratio specified in [Specify Size].	Specify a higher resolution or a large size in [Specify Size], and then scan the original again.

When documents cannot be scanned because the memory is full

Message	Cause	Solution
"Memory is full. Cannot scan. The scanned data will be deleted."	Because of insufficient hard disk space, the first page could not be scanned.	Try one of the following measures: <ul style="list-style-type: none"> • Wait for a while, and then retry the scan operation. • Reduce the scan area or scanning resolution. For details about changing scan area and scanning resolution, see "Scan Settings" of Various Scan Settings, Scan. • Delete unneeded stored files. For details about how to delete stored files, see "Deleting a Stored File", Scan.
"Memory is full. Do you want to store scanned file?"	Because there is not enough free hard disk space in the machine for storing in the Document Server, only some of the pages could be scanned.	Specify whether or not to use the data.
"Memory is full. Scanning has been cancelled. Press [Send] to send the scanned data, or press [Cancel] to delete."	Because there is not enough free hard disk space in the machine for sending by e-mail while data is being stored in the Document Server, only some of the pages could be scanned.	Specify whether or not to use the data.

When data transmission fails

Message	Cause	Solution
"Authentication with the destination has failed. Check settings. To check the current status, press [Scanned Files Status]."	The entered user name or password was invalid.	<ul style="list-style-type: none"> • Check that the user name and password are correct. • Check that the ID and password for the destination folder are correct. • A password of 128 or more characters may not be recognized.
"Exceeded max. email size. Sending email has been cancelled. Check [Max. Email Size] in Scanner Features."	The file size per page has reached the maximum e-mail size specified in [Scanner Features].	<p>Change the scanner features settings as follows:</p> <ul style="list-style-type: none"> • Increase the e-mail size limit in [Max. Email Size]. • Change the [Divide & Send Email] setting to [Yes (per Page)] or [Yes (per Max. Size)]. For details about these settings, see "Send Settings", Scan.
"Sending the data has failed. The data will be resent later."	A network error has occurred and a file was not sent correctly.	Wait until sending is retried automatically after the preset interval. If sending fails again, contact your administrator.
"Transmission has failed. Insufficient memory in the destination hard disk. To check the current status, press [Scanned Files Status]."	Transmission has failed. There was not enough free space on the hard disk of the SMTP server, FTP server, or client computer at the destination.	Allocate sufficient space.
"Transmission has failed. To check the current status, press [Scanned Files Status]."	While a file was being sent, a network error occurred and the file could not be sent correctly.	If the same message appears again after scanning again, the cause could be a mixed network, or network settings were changed during WSD scanner transmission. For details about network error, contact your administrator.

When data cannot be sent because a currently used file is selected

Message	Cause	Solution
"Selected file is currently in use. File name cannot be changed."	You cannot change the name of a file whose status is "Waiting...".	Cancel transmission ("Waiting..." status cleared), and then change the file name.
"Selected file is currently in use. Password cannot be changed."	You cannot change the password of a file whose status is "Waiting...".	Cancel transmission ("Waiting..." status cleared), and then change the password.
"Selected file is currently in use. User name cannot be changed."	You cannot change the sender's name whose status is "Waiting...".	Cancel transmission ("Waiting..." status cleared), and then change the user name.
"Some of selected files are currently in use. They could not be deleted."	You cannot delete a file which is waiting to be transmitted ("Waiting..." status displayed).	Cancel transmission ("Waiting..." status cleared), and then delete the file.

When data cannot be sent because there are too many documents or pages

Message	Cause	Solution
"Exceeded max. number of pages per file. Do you want to store the scanned pages as 1 file?"	The file being stored has exceeded the maximum number of pages for one file.	Specify whether to store the data or not. Scan the pages that were not scanned, and then store them as a new file. For details about storing files, see "Storing and Saving the Scanned Documents", Scan.
"Exceeded max. number of stored files. Cannot send the scanned data as capturing files is unavailable."	Too many files are waiting to be sent.	Try again after they have been sent.
"Exceeded max. page capacity per file. Press [Send] to send the scanned data, or press [Cancel] to delete."	The number of scanned pages exceeded the maximum page capacity.	Specify whether to send the data that has already been scanned.

Message	Cause	Solution
"Exceeded maximum number of file to store. Delete all unnecessary files."	Too many files are waiting to be sent.	Try again after they have been sent.

When the WSD scanner function cannot be used

Message	Cause	Solution
"Cannot communicate with PC. Contact the administrator."	WSD (Device) protocol or WSD (Scanner) protocol is disabled.	For details about how to enable or disable the WSD protocol, see "Enabling and Disabling Protocols", Security Guide.
"Cannot start scanning because communication was failed."	Scan Profile is not set on the client computer.	Set Scan Profile. For details about how to do this, see "Creating a New Scan Profile", Scan.
"Cannot start scanning because communication was failed."	The [Take no action] setting has been selected on the client computer, forcing the client computer to remain inactive when it receives scan data.	Open scanner properties, click the [Events] tab, and then select [Start this program] as the computer's response when it receives scan data. For details, see your operating system's Help.
"Cannot start scanning. Check the setting(s) on the PC."	The Scan Profile might be incorrectly configured.	Check the Scan Profile configuration.

Message	Cause	Solution
"Could not send the data because the PC timed out before it was sent."	<p>A time out occurred when WSD Scanner was used. Time outs occur when too much time passes between scanning an original and sending its data. The followings are likely causes of time outs:</p> <ul style="list-style-type: none"> • Too many originals per set. • Misfed originals. • Transmission of other jobs. 	<ul style="list-style-type: none"> • Reduce the number of originals, and then scan again. • Remove any misfed original, and then scan again. • Use Scanner Journal to check there are no jobs awaiting transmission, and then scan again.

When documents cannot be stored on a memory storage device

Message	Cause	Solution
"Cannot write on the memory storage device because remaining free space is insufficient."	The memory storage device is full and scan data cannot be saved. Even if the memory storage device appears to have sufficient free space, data might not be saved if the maximum number of files that can be saved is exceeded.	<ul style="list-style-type: none"> • Replace the memory storage device. • If the document is scanned as single-page or divided into multiple pages, data already written to the memory storage device is saved as is. Replace the memory storage device, and then press [Retry] to save the remaining data, or press [Cancel] to redo the scan.
"Cannot write on the memory storage device because the device is write-protected."	The memory storage device is write-protected.	Unlock the write-protection on the memory storage device.

Message	Cause	Solution
"Cannot write on the memory storage device. Check the memory storage device and machine settings."	The memory storage device is faulty, or the file name contains a character that cannot be used.	<ul style="list-style-type: none"> • Check to see if the memory storage device is defective. • Check the memory storage device. It might be unformatted, or its format might be incompatible with this machine. • Check the file name set at the time of scanning. For details about the characters that can be used in file names, see "Specifying the File Name", Scan.
"Exceeded max. page capacity per file. Press [Write] to write the scanned data to the memory storage device, or press [Cancel] to delete."	The scan could not be completed because the maximum number of pages that can be scanned by this machine was exceeded during the scanned data was written to the memory storage device.	Reduce the number of documents to be written to the memory storage device, and then try again.
"Memory is full. Press [Write] to write the current scanned data to the memory storage device, or press [Cancel] to delete."	The scan could not be completed because there was insufficient hard disk memory when the scanned data was saved to the memory storage device.	Specify whether or not to save the scanned document to the memory storage device.

Messages Displayed on the Client Computer

This section describes likely causes of and possible solutions for the main error messages displayed on the client computer when you use the TWAIN driver. If a message not described here appears, follow the instruction.

Message	Cause	Solution
"Any of Login User Name, Login Password or Driver Encryption Key is incorrect."	The entered login user name, password, or driver encryption key was invalid.	Check your login user name, login password, or driver encryption key, and then enter them correctly. For details about login user name, login password, and driver encryption key, see "Encrypting Transmitted Passwords", Security Guide.
"Authentication succeeded. However, the access privileges for scanner function has been denied."	The logged in user name does not have permissions for scanner function.	For details about how to set permissions, see "Limiting Available Functions", Security Guide.
"Cannot add any more scanning mode."	The maximum number of registrable scan modes has been exceeded.	The maximum number of modes that can be stored is 100. Delete unneeded modes.
"Cannot detect the paper size of the original. Specify the scanning size."	The set original was misaligned.	<ul style="list-style-type: none"> Place the original correctly. Specify the scan size. When placing an original directly on the exposure glass, the lifting/lowering action of the ADF triggers the automatic original size detection process. Lift the ADF by 30 degrees or more.
"Cannot specify any more scanning area."	The maximum number of registrable scan modes has been exceeded.	The maximum number of scanning areas that can be stored is 100. Delete unneeded scanning areas.
"Clear Misfeed(s) in ADF."	A paper misfeed has occurred inside the ADF.	<ul style="list-style-type: none"> Remove the jammed originals, and then insert them again. For details about jammed paper, see "Removing Jammed Paper", Troubleshooting. When a misfeed occurs, replace the jammed originals. Check whether the originals are suitable to be scanned by the machine.

Message	Cause	Solution
"Error has occurred in the scanner driver."	An error has occurred in the driver.	<ul style="list-style-type: none"> • Check whether the network cable is connected correctly to the client computer. • Check whether the Ethernet board of the client computer is recognized correctly by Windows. • Check whether the client computer can use the TCP/IP protocol.
"Error has occurred in the scanner."	The application-specified scan conditions have exceeded the setting range of the machine.	Check whether the scanning settings made with the application exceed the setting range of the machine.
"Fatal error has occurred in the scanner."	An unrecoverable machine error has occurred.	An unrecoverable machine error has occurred. Contact your service representative.
"Insufficient memory. Close all other applications, then restart scanning."	Memory is insufficient.	<ul style="list-style-type: none"> • Close all the unnecessary applications running on the client computer. • Uninstall the TWAIN driver, and then reinstall it after restarting the computer.

Message	Cause	Solution
<p>"Insufficient memory. Reduce the scanning area."</p>	<p>Scanner memory is insufficient.</p>	<ul style="list-style-type: none"> • Reset the scan size. • Lower the resolution. • Set with no compression. For details about the settings, see TWAIN driver Help. <p>The problem may be due to the following:</p> <ul style="list-style-type: none"> • Scanning cannot be performed if large values are set for brightness when halftone or high resolution is used. For details about the relationship between scan settings, see "Relationship between Resolution and Scan Size", Scan. • If a misfeed occurs, you might not scan an original. Remove the misfeed, and then scan the original again.
<p>"Invalid Winsock version. Please use version 1.1 or higher."</p>	<p>You are using an invalid version of Winsock.</p>	<p>Install the operating system of the computer or copy Winsock from the operating system CD-ROM.</p>
<p>"No response from the scanner."</p>	<p>The machine or client computer is not connected to the network correctly.</p>	<ul style="list-style-type: none"> • Check whether the machine or client computer is connected to the network correctly. • Disable the client computer's own firewall. For details about firewall, see Windows Help.
<p>"No response from the scanner."</p>	<p>The network is crowded.</p>	<p>Wait for a while, and then connect to the network again.</p>

Message	Cause	Solution
"Scanner is in use for other function. Please wait."	A function of the machine other than the Scanner function is being used such as the Copier function.	<ul style="list-style-type: none"> • Wait for a while, and then connect to the network again. • Cancel the job that is being processed. Press the [Stop] key. Follow the instructions in the message that appears and exit the function that is running.
"Scanner is not available on the specified device."	The TWAIN scanner function cannot be used on this machine.	Contact your service representative.
"Scanner is not ready. Check the scanner and the options."	The ADF cover is open.	Check whether the ADF cover is closed.
"The name is already in use. Check the registered names."	You tried to register a name that is already in use.	Use another name.

When there is a problem connecting to the scanner

Message	Cause	Solution
"Cannot connect to the scanner. Check the network Access Mask settings in User Tools."	An access mask is set.	For details about an access mask, contact your administrator.
"Cannot find "XXX" scanner used for the previous scan. "YYY" will be used instead." (("XXX" and "YYY" indicate scanner names.)	The main power of the previously used scanner is not set to "On".	Check whether the main power of the scanner used for the previous scan is turned on.

Message	Cause	Solution
"Cannot find "XXX" scanner used for the previous scan. "YYY" will be used instead." ("XXX" and "YYY" indicate scanner names.)	The machine is not connected to the network correctly.	<ul style="list-style-type: none"> • Check that the previously used scanner is connected to the network correctly. • Cancel the personal firewall of the client computer. For details about firewall, see Windows Help. • Use an application such as telnet to make sure SNMPv1 or SNMPv2 is set as the machine's protocol. For details about how to check this, see "Remote Maintenance Using telnet", Connecting the Machine/ System Settings. • Select the scanner used for the previous scan.
"Communication error has occurred on the network."	A communication error has occurred on the network.	Check whether the client computer can use the TCP/IP protocol.
"Scanner is not available. Check the scanner connection status."	The machine's power is off.	Turn on the power.
"Scanner is not available. Check the scanner connection status."	The machine is not connected to the network correctly.	<ul style="list-style-type: none"> • Check whether the machine is connected to the network correctly. • Cancel the personal firewall function of the client computer. For details about firewall, see Windows Help. • Use an application such as telnet to make sure SNMPv1 or SNMPv2 is set as the machine's protocol. For details about how to check this, see "Remote Maintenance Using telnet", Connecting the Machine/ System Settings.

Message	Cause	Solution
"Scanner is not available. Check the scanner connection status."	Network communication is not available because the machine's IP address could not be obtained from the host name. If only "IPv6" is set to [Active], the IPv6 address might not be obtained.	<ul style="list-style-type: none">• Check whether the machine's host name is specified in the Network Connection Tool. For the WIA driver, check the [Network Connection] tab in the properties.• Use Web Image Monitor to set "LLMNR" of "IPv6" to [Active].

When Other Messages Appear

Message	Cause	Solution
"Firmware update will start. Press [OK]. It will start automatically after 30 seconds have elapsed."	Automatic firmware update is enabled and it is the time for an automatic update.	<ul style="list-style-type: none"> • If you want to start the firmware update, press [OK], or configure the setting so that the automatic firmware update starts automatically in 30 seconds. • If you do not want to start the firmware update, press [Cancel] before 30 seconds elapse. • Do not turn off the power switch during the firmware update.
"Cannot connect with the wireless card. Turn the main power switch off, then check the card." (A "wireless LAN board" is referred to as a "wireless card".)	<ul style="list-style-type: none"> • The wireless LAN board was not inserted when the machine was turned on. • The wireless LAN board was pulled out after the machine was turned on. • The settings are not updated although the unit is detected. 	Turn off the power, and then check the wireless LAN board is inserted correctly. After this, turn on the power again. If the message appears again, contact your service representative.
"Failed to read the PDF file."	There is a possibility that the PDF version is not supported by the browser's PDF viewer or an unsupported encryption level is specified.	With this machine's browser PDF files other than those whose versions and encryption levels are specified below cannot be viewed. <ul style="list-style-type: none"> • PDF version: 1.3-1.7 • PDF encryption level: 128Bit AES or 256Bit AES
"Clean the scanning glass. (Located next to the exposure glass.)"	The scanning glass or guide plate of the ADF is dirty.	Clean the scanning glass or guide plate. See "Maintaining Your Machine", Maintenance and Specifications.

Message	Cause	Solution
"Following output tray is full. Remove paper."	The output tray is full.	Remove paper from the output tray to resume printing. Press [Continue] on the display panel to resume printing. When using the multi-folding unit, the number of sheets per copy paper stack differs depending on the paper type and fold type.
"Internal cooling fan is active."	Large print runs will cause the machine's interior to heat up, triggering the cooling fan.	The fan will emit noise, but this is normal and the machine will be operable while the fan is running. The amount of paper that can be printed and the total operation time until the fan starts running depends on the temperature of the location at which the machine is installed.
"Self checking..."	The machine is performing image adjustment operations.	The machine may perform periodic maintenance during operations. The frequency and duration of maintenance depends on the humidity, temperature, and printing factors such as number of prints, paper size, and paper type. Wait for the machine to resume operation.

When There Is a Problem Scanning or Storing Originals

Message	Cause	Solution
"Cannot detect original size. Select scan size."	The machine failed to detect the size of the original.	<ul style="list-style-type: none"> Place the original correctly. Specify the scan size, and then place the originals again. When placing an original directly on the exposure glass, the lifting/lowering action of the ADF triggers the automatic original size detection process. Lift the ADF by 30 degrees or more.

Message	Cause	Solution
"Captured file exceeded max. number of pages per file. Cannot send the scanned data."	The maximum number of pages per file has been exceeded.	Reduce the number of pages in the transmitted file, and then resend the file. For details about the maximum number of pages per file, see "Storage Function", Scan.
"Original is being scanned by another function. Please wait."	Another function of the machine is being used.	Cancel the job in progress. Press [Exit], and then press the [Stop] key. Follow the instructions in the message that appears and exit the function that is running.

When the Home Screen Cannot Be Edited (When Using the Standard Operation Panel)

Message	Cause	Solution
"The image data size is not valid. See the manual for required data."	The image data size is not valid.	For details about file size for shortcut image, see "Displaying an Image on the [Home] Screen (When Using the Standard Operation Panel)", Convenient Functions.
"The format of the image data is not valid. See the manual for required data."	The file format of the shortcut image to be added is not supported.	The file format of shortcut images to be added must be PNG. Specify the image again.

When the Address Book Is Updated

Message	Cause	Solution
"Updating the destination list has failed. Try again?"	A network error has occurred.	<ul style="list-style-type: none"> • Check whether the server is connected. • Antivirus programs and firewalls can prevent client computers from establishing connection with this machine. • If you are using antivirus software, add the program to the exclusion list in the application settings. For details about how to add programs to the exclusion list, see the antivirus software Help. • To prevent a firewall from blocking the connection, register the machine's IP address in the firewall's IP address exclusion settings. For details about the procedure for excluding an IP address, see your operating system's Help.
"Updating the destination list... Please wait. Specified destination(s) or sender's name has been cleared."	The destination list is being updated from the network using Web Image Monitor.	Wait until the message disappears. Do not turn off the power while this message is displayed. Depending on the number of destinations to be updated, there may be some delay before operation is resumed. Operation is not possible while this message is displayed.
"Updating the destination list... Please wait. Specified destination(s) or sender's name has been cleared."	A specified destination or sender's name was cleared when the destination list in the delivery server was updated.	Specify the destination or sender's name again.

When Data Cannot Be Sent Due to a Problem with the Destination

Message	Cause	Solution
"Some invalid destination(s) contained. Do you want to select only valid destination(s)?"	The specified group contains either an e-mail destination and/or folder destination that is not supported by the specified transmission method.	In the message that appears at each transmission, press [Select].
"SMTP authentication email address and administrator email address mismatch."	The SMTP authentication e-mail address and the administrator's e-mail address do not match.	For details about how to set SMTP authentication, see "File Transfer", Connecting the Machine/ System Settings.

When the Machine Cannot Be Operated Due to a Problem with the User Certificate

Message	Cause	Solution
"The destination cannot be selected because its encryption certificate is not currently valid."	The user certificate (destination certificate) has expired.	A new user certificate must be installed. For details about the user certificate (destination certificate), see "Configuring S/MIME", Security Guide.
"The group destination cannot be selected because it contains a destination with a encryption certificate that is not currently valid."	The user certificate (destination certificate) has expired.	A new user certificate must be installed. For details about the user certificate (destination certificate), see "Configuring S/MIME", Security Guide.
"Transmission cannot be performed because the encryption certificate is not currently valid."	The user certificate (destination certificate) has expired.	A new user certificate must be installed. For details about the user certificate (destination certificate), see "Configuring S/MIME", Security Guide.

Message	Cause	Solution
"XXX cannot be YYY because the device certificate used for the S/MIME signature is not currently valid." (XXX and YYY indicate the user action.)	The device certificate (S/MIME) has expired.	A new device certificate (S/MIME) must be installed. For details about how to install a device certificate (S/MIME), see "Protecting Communication Paths via a Device Certificate", Security Guide.
"XXX cannot be YYY because there is a problem with the device certificate used for the S/MIME signature. Check the device certificate." (XXX and YYY indicate the user action.)	There is no device certificate (S/MIME), or the certificate is invalid.	For details about the device certificate (S/MIME), see "Protecting Communication Paths via a Device Certificate", Security Guide.
"XXX cannot be YYY because the Digital Signature's device certificate is not currently valid." (XXX and YYY indicate the user action.)	The device certificate (PDF with digital signature or PDF/A with digital signature) has expired.	A new device certificate (PDF with digital signature or PDF/A with digital signature) must be installed. For details about how to install a device certificate (PDF with digital signature or PDF/A with digital signature), see "Configuring PDFs with Electronic Signatures", Security Guide.
"XXX cannot be YYY because there is a problem with the Digital Signature's device certificate. Check the device certificate." (XXX and YYY indicate the user action.)	There is no device certificate (PDF with digital signature or PDF/A with digital signature), or the certificate is invalid.	A new device certificate (PDF with digital signature or PDF/A with digital signature) must be installed. For details about how to install a device certificate (PDF with digital signature or PDF/A with digital signature), see "Configuring PDFs with Electronic Signatures", Security Guide.

↓ Note

- If an e-mail cannot be sent and a message appears which states that there is a problem with the device certificate or user certificate, a new certificate must be installed. For details about how to install a new certificate, see "Configuring S/MIME" or "Protecting Communication Paths via a Device Certificate", Security Guide.

When Problems Occur While Logging In

Message	Cause	Solution
"Authentication has failed."	The entered login user name or login password is not correct.	For details about the correct login user name and login password, see "Basic Authentication", Security Guide.
"Authentication has failed."	The machine cannot perform authentication.	For details about authentication, see "Configuring User Authentication", Security Guide.

When the User Lacks Privileges to Perform an Operation

Message	Cause	Solution
"You do not have the privileges to use this function."	The logged in user name does not have permissions for the selected function.	For details about how to set permissions, see "Limiting Available Functions", Security Guide.
"The selected file(s) contained file(s) without access privileges. Only file(s) with access privileges will be deleted."	You have tried to delete files without the permission to do so.	To check your access permission for stored documents, or to delete a document you do not have permission to delete, see "Managing Stored Files", Security Guide.

When the LDAP Server Cannot Be Used

Message	Cause	Solution
"Connection with LDAP server has failed. Check the server status."	A network error has occurred and connection has failed.	<p>Try the operation again. If the message is still displayed, the network may be busy.</p> <p>Check the settings for LDAP server in [System Settings]. For details about settings for LDAP server, see "Programming the LDAP Server", Connecting the Machine/ System Settings.</p>

Message	Cause	Solution
"Exceeded time limit for LDAP server search. Check the server status."	A network error has occurred and connection has failed.	<ul style="list-style-type: none">• Try the operation again. If the message is still displayed, the network may be busy.• Check that the correct settings for LDAP server are listed in [Administrator Tools] of [System Settings]. For details about LDAP server, see "Programming the LDAP Server", Connecting the Machine/ System Settings.
"LDAP server authentication has failed. Check the settings."	A network error has occurred and connection has failed.	Configure settings correctly for the user name and the password for LDAP server authentication.

10. Information for This Machine

This chapter describes environmental precautions and regulations.

Information on Environmental Regulations

ENERGY STAR Program

ENERGY STAR® Program Requirements for Imaging Equipment



This company is a participant in the ENERGY STAR® Program.
This machine is compliant with the regulations specified by the ENERGY STAR® Program.

The ENERGY STAR® Program Requirements for Imaging Equipment encourage energy conservation by promoting energy efficient computers and other office equipment.

The program backs the development and dissemination of products that feature energy saving functions.

It is an open program in which manufacturers participate voluntarily.

Targeted products are computers, monitors, printers, facsimiles, copiers, scanners, and multi-function devices. Energy Star standards and logos are internationally uniform.

↓ Note

- For details about the "default delay time", see page 289 "Energy Saving Functions".

Energy Saving Functions

To reduce its power consumption, this machine has the following functions:

Low Power mode

- If this machine remains idle for a specified period, it automatically reduces its electrical consumption.

- The default period the machine waits before entering Low Power mode is 15 minutes. This default time can be changed.

Sleep mode

- If this machine remains idle for a specified period or when the [Energy Saver] key is pressed, it enters Sleep mode to further reduce its electrical consumption.

-  **Region A** (mainly Europe)

The default delay time the machine waits before entering Sleep mode is 45 minutes. This default time can be changed.

-  **Region B** (mainly North America)

The default delay time the machine waits before entering Sleep mode is 60 minutes. This default time can be changed.

- The machine can print jobs from computers while in Sleep mode.

Specification

-  **Region A** (mainly Europe)

	Type 1	Type 2
Reduced electrical consumption in Low Power mode ^{*1}	154 W	152 W
Time of switch into Low Power mode	15 minutes	15 minutes
Time of switch out from Low Power mode ^{*1*2}	31.7 seconds	32.8 seconds
Reduced electrical consumption in Sleep mode ^{*1}	0.75 W	0.75 W
Time of switch into Sleep mode	45 minutes	45 minutes
Time of switch out from Sleep mode ^{*1}	119 seconds	119 seconds
Duplex Function ^{*3}	Standard	Standard

*1 The time it takes to switch out from energy saving functions and electrical consumption may differ depending on the conditions and environment of the machine.

*2 Image adjustment may take around 100 seconds.

*3 Achieves ENERGY STAR energy savings; product fully qualifies when packaged with (or used with) a duplex tray and the duplex function is enabled as an option.

-  **Region B** (mainly North America)

	Type 1	Type 2
Reduced electrical consumption in Low Power mode ^{*1}	154 W	154 W
Time of switch into Low Power mode	15 minutes	15 minutes
Time of switch out from Low Power mode ^{*1*2}	31.7 seconds	32.8 seconds
Reduced electrical consumption in Sleep mode ^{*1}	0.76 W	0.75 W
Time of switch into Sleep mode	60 minutes	60 minutes
Time of switch out from Sleep mode ^{*1}	119 seconds	119 seconds
Duplex Function ^{*3}	Standard	Standard

*1 The time it takes to switch out from energy saving functions and electrical consumption may differ depending on the conditions and environment of the machine.

*2 Image adjustment may take around 100 seconds.

*3 Achieves ENERGY STAR energy savings; product fully qualifies when packaged with (or used with) a duplex tray and the duplex function is enabled as an option.

↓ Note

- Specifications can vary depending on which options are installed on the machine.
- For details about how to change the default interval, see "Timer Settings", Connecting the Machine/ System Settings.
- The machine enters sleep mode directly in the following situations:
 - Low Power Mode Timer and Sleep Mode Timer are set to the same time
 - Sleep Mode Timer is set to a shorter time than Low Power Mode Timer
- Depending on which embedded software application is installed on it, the machine might take longer than indicated to enter Sleep mode.

User Information on Electrical and Electronic Equipment Region **A** (mainly Europe)

Users in the countries where this symbol shown in this section has been specified in national law on collection and treatment of E-waste

Our Products contain high quality components and are designed to facilitate recycling.

Our products or product packaging are marked with the symbol below.



The symbol indicates that the product must not be treated as municipal waste. It must be disposed of separately via the appropriate return and collection systems available. By following these instructions you ensure that this product is treated correctly and help to reduce potential impacts on the environment and human health, which could otherwise result from inappropriate handling. Recycling of products helps to conserve natural resources and protect the environment.

For more detailed information on collection and recycling systems for this product, please contact the shop where you purchased it, your local dealer or sales/service representatives.

All Other Users

If you wish to discard this product, please contact your local authorities, the shop where you bought this product, your local dealer or sales/service representatives.

10

For Turkey only

AEEE Yönetmeliğine Uygundur.

Bu sistem sarf malzemeleri ve yedek parçaları da dahil olmak üzere AEEE Yönetmeliğine Uygundur.

Üretici:

Ricoh Company, Ltd.

3-6, Nakamagome 1-chome,

Ohta-ku, Tokyo 143-8555 Japan

+81-3-3777-8111(English only/Sadece İngilizce)

Note for the Battery and/or Accumulator Symbol (For EU countries only)

 Region **A** (mainly Europe)



In accordance with the Battery Directive 2006/66/EC Article 20 Information for end-users Annex II, the above symbol is printed on batteries and accumulators.

This symbol means that in the European Union, used batteries and accumulators should be disposed of separately from your household waste.

In the EU, there are separate collection systems for not only used electrical and electronic products but also batteries and accumulators.

Please dispose of them correctly at your local community waste collection/recycling centre.

Contact your sales or service representative to change the battery.

Environmental Advice for Users Region **A** (mainly Europe)

Users in the EU, Switzerland and Norway

Consumables yield

Please refer to either the User's Manual for this information or the packaging of the consumable.

Recycled paper

The machine can use recycled paper which is produced in accordance with European standard EN 12281:2002 or DIN 19309. For products using EP printing technology, the machine can print on 64 g/m² paper, which contains less raw materials and represents a significant resource reduction.

Duplex printing (if applicable)

Duplex printing enables both sides of a sheet of paper to be used. This saves paper and reduces the size of printed documents so that fewer sheets are used. We recommend that this feature is enabled whenever you print.

Toner and ink cartridge return program

Toner and ink cartridge for recycling will be accepted free of charge from users in accordance with local regulations.

For details about the return program, please refer to the Web page below or consult your service person.

<https://www.rioh-return.com/>

Energy efficiency

The amount of electricity a machine consumes depends as much on its specifications as it does on the way you use it. The machine is designed to allow you to reduce electricity costs by switching to Ready mode after it prints the last page. If required, it can immediately print again from this mode. If no additional prints are required and a specified period of time passes, the device switches to an energy saving mode.

In these modes, the machine consumes less power (watts). If the machine is to print again, it needs a little longer to return from an energy saving mode than from Ready mode.

For maximum energy savings, we recommend that the default setting for power management is used.

Products that comply with the Energy Star requirement are always energy efficient.

Notes to users in the state of California (Notes to Users in USA) Region B (mainly North America)

Perchlorate Material - special handling may apply. See: www.dtsc.ca.gov/hazardouswaste/perchlorate

INDEX

2 Sided Print..... 11

A

A3/11 × 17 tray unit..... 31, 167
Adding toner..... 222
Address Book..... 13, 137, 139, 140, 145, 147
ADF..... 10, 25
ADF's extender..... 27
Anti-humidity heater switch..... 27
Attention light..... 26, 28
Authentication screen..... 87
Auto Document Feeder..... 10
Auto Reduce / Enlarge..... 16, 95, 96

B

Banner sheet guide tray..... 30
Basic procedure..... 121, 157
Basic procedure (Copier Classic)..... 93
Basic procedure (Copy)..... 93
Basic Procedure (Scanner Classic).. 133, 143, 149
Basic procedure (Scanner)..... 133, 143
Beeping pattern..... 234
Booklet Finisher SR4130..... 32, 33, 35, 39
Booklet Finisher SR5080..... 31, 34, 37, 39
Buffer pass unit..... 31
Bypass tray..... 27, 109, 110, 112, 172, 192

C

Changing the display language..... 45, 46
Check Status..... 231
Check Status key..... 43
Checking a stored file..... 150
Classic Application..... 64
Clear key..... 43
Color adjustment..... 16
Color copy..... 16
Combine..... 11, 16, 103
Combine 1 Side..... 104
Combine 2 Sides..... 106
Combine printing..... 123
Computer..... 273
Control panel..... 25, 41, 44

Copier..... 243
Copy..... 65, 93
Copy connector..... 31
Copy orientation..... 100, 101
Copy tray..... 30
Counter key..... 42
Creating a shared folder..... 135
Custom size paper..... 109, 110

D

Data In indicator..... 43, 44
Data security for copying..... 23
Decurler unit..... 31
Destination..... 284
Display panel..... 41, 44
Distributed scan management..... 21
Document Server..... 12, 17, 118, 127, 128, 157,
159, 243, 256
Drawer..... 26
DSM..... 21
Duplex..... 11, 16, 98, 100

E

E-mail address..... 145, 147, 148
E-mail destination..... 145, 147, 148
Embedding text information..... 20
Energy Saver key..... 42
Enter key..... 42
Envelope..... 16, 111, 112, 125, 126, 209
Error log..... 251
Error report..... 251
Exposure glass..... 25
Extender..... 27
Extension unit..... 31, 197
External options..... 30

F

File type..... 152, 153
Finisher SR4120..... 32, 33, 35, 39
Finisher SR5070..... 31, 34, 37, 39
Finishing..... 16
Folder destination..... 137, 139, 140, 141
Frequently-used settings..... 13
Front cover..... 26

Function Compatibility.....	241
Function keys.....	43

H

Hold Print.....	17
Home key.....	43
Home screen.....	15, 47, 48
How to Read the Manuals.....	7

I

Icon.....	47
Image adjustment.....	16
Indicator lamp.....	231
Information screen.....	11
Interposer.....	31, 183, 203
Interrupt key.....	42

L

Label paper.....	189
LAN-Fax.....	11
Language key.....	42
Large Capacity Tray.....	10
LCT.....	10, 31, 178, 197
LDAP server.....	286
Loading paper.....	163, 165, 167, 168, 172, 178, 179, 183, 184
Locked Print.....	17
Logging in the machine.....	87, 88, 286
Logging out the machine.....	89
Login/Logout key.....	42
Lower front cover.....	26

M

Mailbox.....	32
Main power indicator.....	42, 44
Main power switch.....	26, 85
Managing documents.....	128
Memory.....	258, 268
Memory Storage Device.....	130
Message.....	235, 243, 248, 250, 251, 254, 256, 257, 258, 259, 260, 263, 266, 268, 269, 270, 271, 272, 273, 277, 280, 281, 282, 283, 284, 286
Model-Specific information.....	9
Multi bypass banner sheet tray.....	30

Multi-folding unit.....	31, 35, 37
-------------------------	------------

N

Names of Major Features.....	10
Number keys.....	43

O

OCR unit.....	20
One-Sided combine.....	104
Options.....	30
Orientation-fixed paper.....	186
Original orientation.....	100, 101

P

Paper capacity.....	189
Paper guides.....	27
Paper Setting key.....	42
Paper size.....	189
Paper thickness.....	206
Paper tray.....	26, 112, 189
Paper type.....	189
Paper weight.....	189
Paperless Fax.....	11
PCL.....	119
PCL 6.....	121, 123, 126
Placing originals.....	90
Preventing information leakage.....	21
Printer.....	121, 248, 250, 251, 254, 256, 257, 258, 259, 260
Printer driver properties.....	120
Privilege.....	286
Problem.....	235, 281
Program.....	13
Program key.....	42

Q

Quick Application.....	64
Quick Install.....	119
Quick Print Release.....	129

R

Recommended paper.....	189
Reducing my Costs.....	11
Region A.....	9
Region B.....	9

Registering destinations.....	13
Reset key.....	41
Running out of toner.....	224

S

Sample Copy key.....	43
Sample Print.....	17
Scan Settings.....	154
Scan to E-mail.....	143
Scan to Folder.....	19, 133
Scanner.....	67, 133, 143, 149, 263, 266, 268, 269, 270, 271, 272, 273, 277
Sending scan files.....	12, 19
Shared folder.....	135
Shortcut icon.....	47
Simple Screen key.....	42
Smart Operation Panel.....	30
SMB folder.....	137, 139, 140
Sort.....	16, 114, 115
Standard Application.....	64
Standard printing.....	121
Start key.....	42
Status icon.....	229
Status indicator.....	44
Stop key.....	43
Stored documents.....	17, 159
Stored Print.....	17
Storing data.....	118, 157
Storing documents.....	127
Storing scan files.....	12, 149
Symbols.....	7

T

Thick paper.....	208
Toner.....	222, 224
Translucent paper.....	189
Tray.....	26
Tray 1.....	165, 189
Tray 2.....	168, 190
Tray 3.....	168, 190
Turning off the power.....	85
Turning on the power.....	85
Twin interposer.....	31, 184, 204
Two-Sided combine.....	106

Two-sided paper.....	186
Two-sided printing.....	122

U

Unauthorized copy prevention.....	23
Upper right cover.....	27
Used toner.....	224
User certificate.....	284
User Code Authentication.....	87
User Tools key.....	42
Using scanned files on the computer.....	12

V

Vents.....	27
------------	----

W

Web Image Monitor.....	22, 161
Wide LCT.....	31, 198
WSD scanner.....	19

MEMO

MEMO

MEMO

