

Quick Reference Copy Guide

➔ Please put this guide above your machine ➔

*The shape of the machine, screen displays, procedures, and titles in references vary depending on the machine you are using. Also, not all functions are available on all machines.

Tips

Paper Size

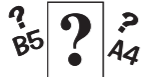

Paper Size

You can check the paper size using the scale on the exposure glass.

Auto Image Density

Dark texture originals will be copied so that background will not be reproduced.

Auto Paper Select

Selects a suitable size of paper automatically.

How to make Copies... (Placing Originals, Paper Specifications and Adding Paper, Basic Copying)

1 Press [Home] at the bottom of the screen in the center. Flick the screen to the left, and then press the [Copier] icon on Home screen 4.

2 Press [Reset].

3 Place the originals.

- Exposure Glass (Face down)

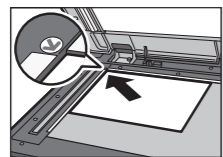

- Auto Document Feeder (Face up)

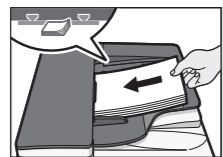

4 Make desired settings.

5 Enter the number of copies.

6 Press [Start].

How to select a color mode... (Color Copying)

1 Select a color mode.

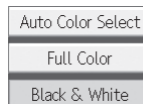

How to Reduce/Enlarge... (Basic Copying)

Auto Reduce/Enlarge

1 Press [Auto Reduce / Enlarge].

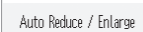

2 Select the paper size.

3 Place the originals, and then press [Start].

Preset Reduce/Enlarge

1 Press [Reduce / Enlarge].

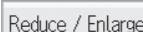

2 Select a ratio, and then press [OK].

3 Place the originals, and then press [Start]. (Paper size is selected automatically.)

1. Display panel

2. [Reset]
Press to clear the current settings.

3. [Energy Saver]

4. Main power indicator

5. [#] (Enter)

6. [Stop]

Press to stop a job in progress, such as copying, scanning, faxing, or printing.

7. [Start]

Press to start copying, printing, scanning, or sending.

8. [C] (Clear)

Press to delete a number entered.

9. Number keys

10. [Menu]

11. [Simplified Scrn.]

12. [Home]

Press to display the [Home] screen.

13. [Return]

14. [Recall/Program/Change Program]

Press to register frequently used settings, or to recall registered settings.

15. [Check Status]

16. Status indicator

17. Media slots

18. Media access lamp

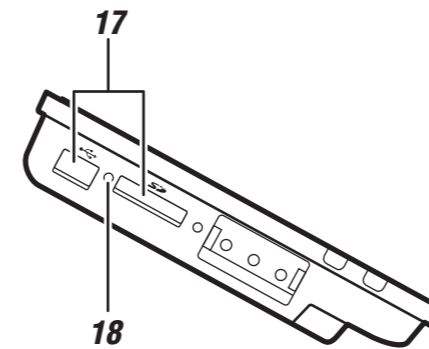
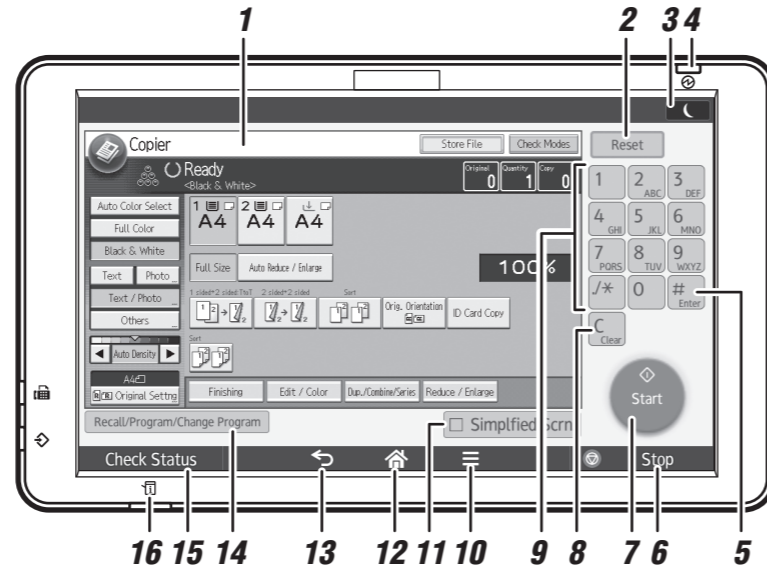

How to save paper... (Basic Copying)

1 See if original is 1-sided or 2-sided (duplex).

2 Press [Dup./Combine/Series].

3 Select the original and copy types and/or the orientation.

4 Place the originals, and then press [Start].



Duplex

1-Sided → 2-Sided

Copies two 1-sided pages on one 2-sided page.



2-Sided → 2-Sided

Copies one 2-sided page on one 2-sided page.

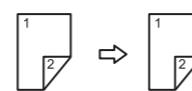

Combine

1-sided Combine

Copies multiple 1-sided or 2-sided originals on one side of copy paper.

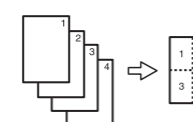

2-sided Combine

Copies multiple 1-sided originals on two sides of copy paper.

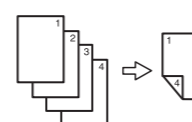

Copies multiple 2-sided originals on two sides of copy paper.

! For more functions on Combine, see "Basic Copying", Copy/ Document Server.

How to finish your document... (Basic Copying)

Staple

1 Press [Finishing].

2 Press [Finisher] when the key is displayed.

3 Select one of the stapling positions (Copies will be sorted automatically).

4 Press [OK].

5 Enter the number of copies.

6 Place the originals, and then press [Start].

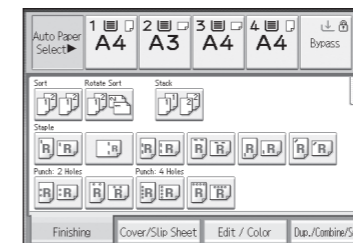

Punch

1 Press [Finishing].

2 Press [Finisher] when the key is displayed.

3 Select one of the punch hole positions (Copies will be hole punched).

4 Press [OK].

5 Enter the number of copies.

6 Place the originals, and then press [Start].

! Staple and Punch can be done at the same time.

! Availability of finishing depends on your configuration.

Document Server (Basic Copying)

Why use it...

- To store often used documents centrally and print on demand.
- To reduce network load.

How to use in copy mode...

1 Press [Store File].

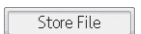

2 Enter a user name, file name, or password if necessary.



3 Specify a folder in which to store the document if necessary.

4 Press [OK].

5 Place the originals.

6 Make the scanning settings for the original.

7 Press [Start].

The machine stores scanned originals in memory and makes one set of copies.

To find your document, press [Home] at the bottom of the screen in the center, and press the [Document Server] icon on the screen.

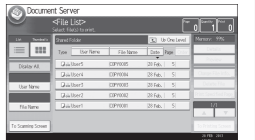

! For more functions on Document

! Server, see "Document Server", Copy/ Document Server.

Simple Screen

When you press [Simplified Scrn.], the screen changes to the simple screen. Letters and keys are displayed at a larger size, making operations easier.

Only the main functions can be used.

Advanced features (Basic Copying, Advanced Copying)

Reduce/Enlarge

• Zoom: You can specify the reproduction ratio in increments of 1%.

• Magnification: You can specify the horizontal and vertical reproduction ratios, individually.

Series Copies

• Separately copies the front and back of a 2-sided original onto two sheets.

Booklet/Magazine

• Copies two or more originals in page order.

Edit/Stamp

• Image Repeat/Double Copies: The original image is copied repeatedly.

• Centering: Moves image to the center.

• Erase: Erases the center and/or all four sides of the original image.

• Stamps: Copies with the date, page numbers, etc.

Cover/Slip Sheet

• Covers: Create cover sheets.

• Designate: Copies certain pages of the original onto designation sheets.