8016/8020/8020d
DSm616/DSm620/DSm620d
LD116/LD120/LD120d
Aficio™ 2016/2020/2020D

Operating Instructions
Copy Reference



-
- 1** Placing Originals
 - 2** Copying
 - 3** Troubleshooting
 - 4** User Tools (Copier Features)
 - 5** Remarks
 - 6** Specifications

Introduction

This manual contains detailed instructions and notes on the operation and use of this machine. For your safety and benefit, read this manual carefully before using the machine. Keep this manual in a handy place for quick reference.

Important

Contents of this manual are subject to change without prior notice. In no event will the company be liable for direct, indirect, special, incidental, or consequential damages as a result of handling or operating the machine.



Notes

Some illustrations in this manual might be slightly different from the machine.

Certain options might not be available in some countries. For details, please contact your local dealer.



Laser Safety:

CDRH Regulations

This equipment complies with requirements of 21 CFR subchapter J for class 1 laser products. This equipment contains a 5 milliwatt, 760-800 nanometer wavelength, GaAlAs laser diode. This equipment does not emit hazardous light, since the beam is totally enclosed during all customer modes of operation and maintenance.

Caution:

Use of controls or adjustment or performance of procedures other than those specified in this manual might result in hazardous radiation exposure.

Notes:

The model names of the machines do not appear in the following pages. Check the type of your machine before reading this manual. (For details, see P.7 "Machine Types".)

- Type 1: 8016/DSm616/LD116/Aficio 2016
- Type 2: 8020/DSm620/LD120/Aficio 2020
- Type 3: 8020d/DSm620d/LD120d/Aficio 2020D

Certain types might not be available in some countries. For details, please contact your local dealer.

Two kinds of size notation are employed in this manual. With this machine refer to the inch version.

For good copy quality, the supplier recommends that you use genuine toner from the supplier.

The supplier shall not be responsible for any damage or expense that might result from the use of parts other than genuine parts from the supplier with your office products.

Power Source

120V, 60Hz, 12A or more

Please be sure to connect the power cord to a power source as above. For details about power source, see P.59 "Power Connection".

Manuals for This Machine

The following manuals describe the operational procedures of this machine. For particular functions, see the relevant parts of the manual.

Note

- Manuals provided are specific to machine type.
- Adobe Acrobat Reader is necessary to view the manuals as a PDF file.
- Two CD-ROMs are provided:
 - CD-ROM 1 "Operating Instructions for Printer/Scanner"
 - CD-ROM 2 "Scanner Driver & Document Management Utilities"

General Settings Guide

Provides an overview of the machine and describes System Settings (paper trays, Key Operator Tools, etc.), and troubleshooting. Refer to this manual for Address Book procedures such as registering fax numbers, e-mail addresses, and user codes.

Network Guide (PDF file - CD-ROM1)

Describes procedures for configuring the machine and computers in a network environment.

Copy Reference (this manual)

Describes operations, functions, and troubleshooting for the machine's copier function.

Facsimile Reference <Basic Features>

Describes operations, functions, and troubleshooting for the machine's facsimile function.

Facsimile Reference <Advanced Features>

Describes advanced functions and settings for key operators.

Printer Reference 1

Describes system settings and operations for the machine's printer function.

Printer Reference 2 (PDF file - CD-ROM1)

Describes operations, functions, and troubleshooting for the machine's printer function.

Scanner Reference (PDF file - CD-ROM1)

Describes operations, functions, and troubleshooting for the machine's scanner function.

❖ **Manuals for DeskTopBinder Lite**

DeskTopBinder Lite is a utility included on the CD-ROM labeled "Scanner Driver & Document Management Utilities".

- DeskTopBinder Lite Setup Guide (PDF file - CD-ROM2)
Describes installation of, and the operating environment for DeskTopBinder Lite in detail. This guide can be displayed from the **[Setup]** dialog box when DeskTopBinder Lite is installed.
- DeskTopBinder Lite Introduction Guide (PDF file - CD-ROM2)
Describes operations of DeskTopBinder Lite and provides an overview of its functions. This guide is added to the **[Start]** menu when DeskTopBinder Lite is installed.
- Auto Document Link Guide (PDF file - CD-ROM2)
Describes operations and functions of Auto Document Link installed with DeskTopBinder Lite. This guide is added to the **[Start]** menu when DeskTopBinder Lite is installed.

❖ **Manuals for ScanRouter V2 Lite**

ScanRouter V2 Lite is a utility included on the CD-ROM labeled "Scanner Driver & Document Management Utilities".

- ScanRouter V2 Lite Setup Guide (PDF file - CD-ROM2)
Describes installation of, settings, and the operating environment for ScanRouter V2 Lite in detail. This guide can be displayed from the **[Setup]** dialog box when ScanRouter V2 Lite is installed.
- ScanRouter V2 Lite Management Guide (PDF file - CD-ROM2)
Describes delivery server management and operations, and provides an overview of ScanRouter V2 Lite functions. This guide is added to the **[Start]** menu when ScanRouter V2 Lite is installed.

❖ **Other manuals**

- PostScript3 Supplement (PDF file - CD-ROM1)
- Unix Supplement (Available from an authorized dealer, or as a PDF file on our Web site.)

TABLE OF CONTENTS

Manuals for This Machine	i
Notice	1
How to Read This Manual	3
Names of Major Options	3
Safety Information	4
Safety During Operation	4
Positions of Labels and Hallmarks for ⚠WARNING and ⚠CAUTION Labels ...	6
Machine Types	7
Control Panel	8
Display	10
Reading the Display and Using Keys	10
Turning On the Power	12
Turning On the Main Power	12
Turning On the Power	12
Turning Off the Power	13
Turning Off the Main Power	13
Saving Energy	14



1. Placing Originals

Originals	15
Sizes and Weights of Recommended Originals	15
Sizes Detectable with Auto Paper Select	16
Missing Image Area	17
Placing Originals	18
Original Orientation	18
Placing Originals on the Exposure Glass	18
Placing Originals in the ADF or ARDF	19

2. Copying

Basic Procedure	21
Copying from the Bypass Tray	22
Copier Functions	26
Adjusting Image Density	26
Selecting Original Type Setting	26
Selecting Copy Paper	26
Preset Reduce/Enlarge	27
Zoom	28
Auto Reduce/Enlarge	29
Sort.....	30
Duplex (Type 3 only)	31
One-Sided Combine.....	33
Two-Sided Combine (Type 3 only).....	35
Series Copies.....	37

3. Troubleshooting

If Your Machine Does Not Operate As You Want	39
When a Message Is Displayed.....	39
If You Cannot Make Clear Copies	40
If You Cannot Make Copies As You Want	41
When Memory Is Full	42
 Loading Paper	43
Loading Paper.....	43
Orientation-Fixed Paper or Two-Sided Paper	44
 Adding Toner	47
Handling Toner.....	47
Toner Storage	47
Used Toner	47
Removing Toner	48
Inserting Toner	49

4. User Tools (Copier Features)

Accessing User Tools (Copier Features)	51
Changing Default Settings	51
Quitting User Tools	52
Settings You Can Change with User Tools	53
APS/ Auto R/E Priority	53
Auto Tray Switching	53
Original Type Setting	53
Duplex Mode Priority.....	54
Orientation.....	54
Max. Number of Sets	54
Original Count Display	54
Reproduction Ratio	54
Preset R/E Priority	55
Duplex Margin	55
Rotate Sort.....	55
Rotate Sort:Auto Continue	55
Letterhead Setting.....	55

5. Remarks

Do's and Don'ts	57
Where to Put Your Machine	58
Machine Environment	58
Moving.....	59
Power Connection.....	59
Access to the Machine	60
Maintaining Your Machine	61
Cleaning the Exposure Glass.....	61
Cleaning the Exposure Glass Cover	61
Cleaning the ADF or ARDF	61

6. Specifications

Combination Chart.....	63
Supplementary Information	64
INDEX.....	67

Notice

Important

Do not copy any item for which copying is prohibited by law.

Copying the following items is generally prohibited by local law:

bank notes, revenue stamps, bonds, stock certificates, bank drafts, checks, passports, and driver's licenses.

Notice To Wireless LAN Interface (option) Users

Notes to users in the United States of America

Notice:

This equipment has been tested and found to comply with the limits for a Class B digital device, pursuant to Part 15 of the FCC Rules. These limits are designed to provide reasonable protection against harmful interference in a residential installation. This equipment generates, uses and can radiate radio frequency energy and, if not installed and used in accordance with the instructions, may cause harmful interference to radio communications. However, there is no guarantee that interference will not occur in a particular installation. If this equipment does cause harmful interference to radio or television reception, which can be determined by turning the equipment off and on, the user is encouraged to try to correct the interference by one more of the following measures:

- Reorient or relocate the receiving antenna.
- Increase the separation between the equipment and receiver.
- Connect the equipment into an outlet on a circuit different from that to which the receiver is connected.
- Consult the dealer or an experienced radio/TV technician for help.

This device complies with part 15 of the FCC Rules.

Operation is subject to the following two conditions:

(1) This device may not cause harmful interference, and (2) this device must accept any interference received, including interference that may cause undesired operation.

Warning

Changes or modifications not expressly approved by the party responsible for compliance could void the user's authority to operate the equipment.

Note to users in Canada

Note:

This Class B digital apparatus complies with Canadian ICES-003.

Operation is subject to the following two conditions:

(1) This device may not cause interference, and (2) this device must accept any interference, including interference that may cause undesired operation of the device.

IEEE 802.11b Interface Unit Type D:

This device complies with RSS-210 of Industry Canada.

The term "IC:" before the certification/registration number only signifies that the Industry Canada technical specifications were met.

To prevent radio interference to the licensed service, this device is intended to be operated indoors and away from windows to provide maximum shielding. Equipment (or its transmit antenna) that is installed outdoors is subject to licensing.

Remarque concernant les utilisateurs au Canada

Avertissement:

Cet appareil numérique de la classe B est conforme à la norme NMB-003 du Canada.

L'utilisation de ce dispositif est autorisée seulement aux conditions suivantes: (1) il ne doit pas produire de brouillage et (2) l'utilisateur du dispositif doit être prêt à accepter tout brouillage radioélectrique reçu, même si ce brouillage est susceptible de compromettre le fonctionnement du dispositif.

IEEE 802.11b Interface Unit Type D:

Ce dispositif est conforme à la norme CNR-210 d'Industrie Canada.

L'expression «IC:» avant le numéro d'homologation/enregistrement signifie seulement que les spécifications techniques d'Industrie Canada ont été respectées.

Pour empêcher que cet appareil cause du brouillage au service faisant l'objet d'une licence, il doit être utilisé à l'intérieur et devrait être placé loin des fenêtres afin de fournir un écran de blindage maximal.

Si le matériel (ou son antenne d'émission) est installé à l'extérieur, il doit faire l'objet d'une licence.

How to Read This Manual

Symbols

The following set of symbols is used in this manual.

WARNING:

This symbol indicates a potentially hazardous situation that might result in death or serious injury when you misuse the machine without following the instructions under this symbol. Be sure to read the instructions, all of which are described in the Safety Information section.

CAUTION:

This symbol indicates a potentially hazardous situation that might result in minor or moderate injury or property damage that does not involve personal injury when you misuse the machine without following the instructions under this symbol. Be sure to read the instructions, all of which are described in the Safety Information section.

* The statements above are notes for your safety.

Important

If this instruction is not followed, paper might be misfed, originals might be damaged, or data might be lost. Be sure to read this.

Preparation

This symbol indicates information or preparations required prior to operating.

Note

This symbol indicates precautions for operation, or actions to take after abnormal operation.

Limitation

This symbol indicates numerical limits, functions that cannot be used together, or conditions in which a particular function cannot be used.

Reference

This symbol indicates a reference.

[]

Keys that appear on the machine's display panel.

【 】

Keys built into the machine's control panel.

Names of Major Options

Major options of this machine are referred to as follows in this manual:

- Auto Document Feeder → ADF
- Auto Document Feeder capable of scanning both sides of a sheet → ARDF

Safety Information

When using this machine, the following safety precautions should always be followed.

Safety During Operation

In this manual, the following important symbols are used:

- | |
|--|
| <p>⚠ WARNING:
<i>Indicates a potentially hazardous situation which, if instructions are not followed, could result in death or serious injury.</i></p> <p>⚠ CAUTION:
<i>Indicates a potentially hazardous situation which, if instructions are not followed, may result in minor or moderate injury or damage to property.</i></p> |
|--|

⚠ WARNING:

- **Disconnect the power plug (by pulling the plug, not the cable) if the power cable or plug becomes frayed or otherwise damaged.**
- **To avoid hazardous electric shock or laser radiation exposure, do not remove any covers or screws other than those specified in this manual.**
- **Turn off the power and disconnect the power plug (by pulling the plug, not the cable) if any of the following occurs:**
 - **You spill something into the machine.**
 - **You suspect that your machine needs service or repair.**
 - **The external housing of your machine has been damaged.**
- **Do not incinerate spilled toner or used toner. Toner dust might ignite when exposed to an open flame.**
- **Disposal can take place at our authorized dealer.**
- **Dispose of the used toner bottle in accordance with the local regulations.**
- **Connect the machine only to the power source described on the inside front cover of this manual. Connect the power cord directly into a wall outlet and do not use an extension cord.**
- **Do not damage, break or make any modifications to the power cord. Do not place heavy objects on it. Do not pull it hard nor bend it more than necessary. These actions could cause an electric shock or fire.**

⚠ CAUTION:

- *Protect the machine from dampness or wet weather, such as rain and snow.*
- *Unplug the power cord from the wall outlet before you move the machine. While moving the machine, you should take care that the power cord will not be damaged under the machine.*
- *When you disconnect the power plug from the wall outlet, always pull the plug (not the cable).*
- *Do not allow paper clips, staples, or other small metallic objects to fall inside the machine.*
- *Keep toner (used or unused) and toner bottle out of the reach of children.*
- *For environmental reasons, do not dispose of the machine or expended supply waste at household waste collection points. Disposal can take place at an authorized dealer.*
- *The inside of the machine could be very hot. Do not touch the parts with a label indicating the “hot surface”. Otherwise, an injury might occur.*
- *Keep the machine away from humidity and dust. Otherwise a fire or an electric shock might occur.*
- *Do not place the machine on an unstable or tilted surface. If it topples over, an injury might occur.*
- *Before moving the machine, be sure to pull all four handles fully out. If not, an injury might occur. After moving the machine, return the four handles to their original positions.*
- *When the optional paper tray unit is installed, do not push the upper part of the main unit horizontally. An injury might occur if the paper tray unit becomes detached from the main unit.*
- *If you use the machine in a confined space, make sure there is a continuous air turnover.*

Positions of Labels and Hallmarks for ⚠️WARNING and ⚠️CAUTION Labels

This machine has labels for ⚠️WARNING and ⚠️CAUTION at the positions shown below. For safety, please follow the instructions and handle the machine as indicated.

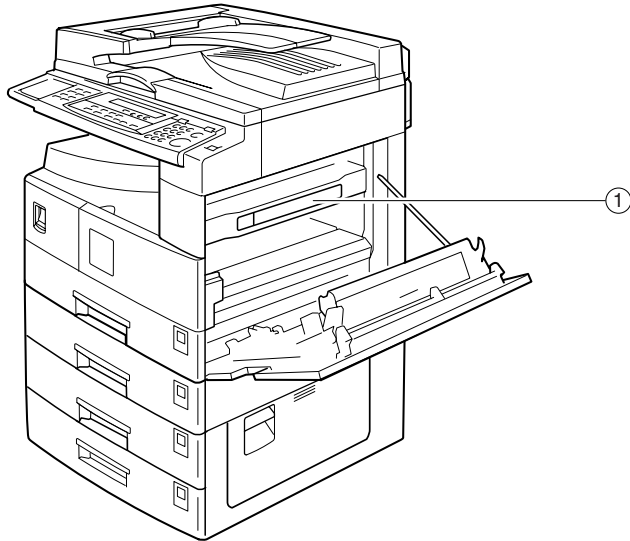







①

 CAUTION 주의 ATTENTION 주의 ACHTUNG ATTENZIONE PRECAUTION	 130°C	 110°C	<ul style="list-style-type: none"> • High temperature. Be careful of hot parts when clearing paper jams. • Température élevée. Attention aux pièces chaudes en supprimant un bourrage papier. • 고온이므로 종이 걸림 제거시 주의해 주십시오. • Vorsicht hohe Temperaturen! Achten Sie auf heiße Gerüstteile, wenn Sie einen Papierstau beheben. • 高温。清障・紙詰り時小心熱燙の恐れ。 	<ul style="list-style-type: none"> • Temperatura elevata. Fare attenzione alle parti calde quando si eliminano gli inceppamenti della carta. • Alta temperatura. Tenga cuidado con las partes calientes cuando elimine los atascamientos de papel.
---	-----------	-----------	--	--

AAI029S

Machine Types

This machine comes in three models which vary by copy speed. To make sure which model you have, see the inside front cover of this manual.

	Type 1	Type 2 ^{*1}	Type 3 ^{*1}
Copy Speed	16 copies/minute (A4  , 8 1/2" x 11" )	20 copies/minute (A4  , 8 1/2" x 11" )	21 copies/minute (A4  , 8 1/2" x 11" )
Duplex unit	—	—	○

○: Can be used with this type.

—: Cannot be used with this type.

^{*1} 18 copies/minute (feeding from Optional Paper Tray Unit)

Control Panel

Note

☐ These illustrations show Type 3.

◆ Copier only

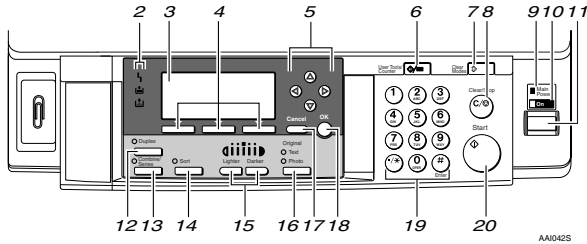

AAI042S

◆ Options fully installed

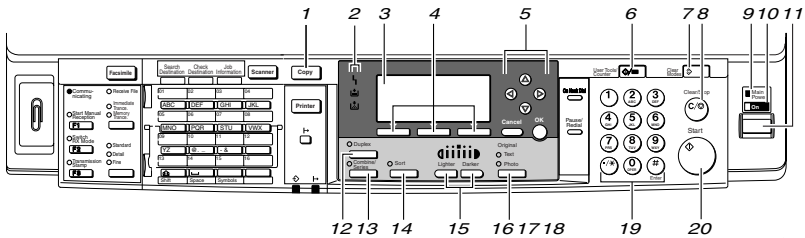

AAI041S

1. [Copy] key

Press to activate the copier function.

2. Indicators

Display errors and machine status.

- : Error indicator
See "Control Panel", *General Settings Guide*.
- : Add Toner indicator
See p.47 " Adding Toner".
- : Load Paper indicator
See p.43 " Loading Paper".

3. Display

Displays operation status and messages.

4. Selection keys

Correspond to items on the display. Press to select the corresponding item.

5. Scroll keys

Press to select an item.

: scroll upward

: scroll downward

: scroll right

: scroll left

Reference

See p.10 "Reading the Display and Using Keys".

6. [User Tools/Counter] key

Press to change default or operation parameters according to requirement.

7. [Clear Modes] key

Press to clear the current settings.

8. [Clear/Stop] key

Clear: clears an entered numeric value.

Stop: stops copying.

9. Main power indicator

Lights when the main power switch is turned on.

Reference

p.12 "Turning On the Power"

10. On indicator

Lights when the operation switch is on.

Reference

p.12 "Turning On the Power"

11. Operation switch

Press to turn the power on. The On indicator lights. To turn the power off, press again.

Note

This key is inactivate during scanning or while setting defaults.

12. **【Duplex】** key (Type 3 only)

Makes two-sided copies.

Reference

See p.31 "Duplex (Type 3 only)".

13. **【Combine/Series】** key

Press to make combine or series copies.

Reference

p.33 "One-Sided Combine"

p.35 "Two-Sided Combine (Type 3 only)"

p.37 "Series Copies"

14. **【Sort】** key

Automatically sorts copies.

15. **【Lighter】** and **【Darker】**

Press to change the image density setting. Select the image density in five increments, Lighter to Darker.

16. **【Original】** key

Press to select the original type registered with **【Original Type 1 (Text)】** or **【Original Type 2 (Photo)】**. When the original type is selected, the corresponding indicator lights.

17. **【Cancel】** key

Press to cancel an operation or return to the previous display.

18. **【OK】** key

Press to set a selected item or entered numeric value.

19. Number keys

Press to enter numeric values.

20. **【Start】** key

Press to start scanning or sending.

Display

This section explains how to read the display and use the Selection key for the initial copy display.

Note

- The copy display is set as the default screen when the machine is turned on.

◆ Initial copy display

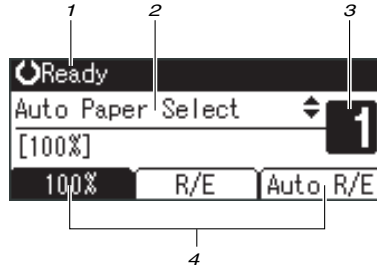

AA10245

1. Operational status or messages

2. Messages and the selected tray appear here. Currently selected items appear in brackets.

3. Number of copies set.

4. Reduce/Enlarge ratio function for non-fixed ratios.

Reading the Display and Using Keys

This section explains how to read the display and use the selection key for the initial copy display.

Note

- The copy display is set as the default screen when the machine is turned on.

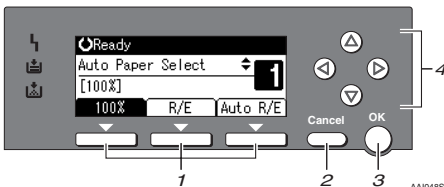

AA10485

1. Selection keys

Correspond to items at the bottom line on the display.

Example: initial copy display

- When the instruction “press [100%]” appears in this manual, press the left selection key.

- When the instruction “press [R/E]” appears in this manual, press the center selection key.
- When the instruction “press [Auto R/E]” appears in this manual, press the right selection key.

2. [Cancel] key

Press to cancel an operation or return to the previous display.

3. [OK] key

Press to set a selected item or entered numeric value.

4. Scroll keys

Press to move the cursor to each direction one by one.

When **[▲]**, **[▼]**, **[▶]**, or **[◀]** key appears in this manual, press the scroll key of the same direction.

Turning On the Power

This machine has two power switches.

❖ Operation switch (right side of the control panel)

Press to activate the machine. When the machine has finished warming up, you can operate the machine.

❖ Main power switch (left side of the machine)

Turning off this switch makes the main power indicator on the right side of the control panel go off. When this is done, machine power is completely off.

When the fax unit (optional) is installed, fax files in memory may be lost if you turn this switch off. Use this switch only when necessary.

Note

- This machine automatically enters Energy Saver mode or turns itself off if you do not use it for a while. See *General Settings Guide*.

Turning On the Main Power

1 Make sure the power cord is firmly plugged into the wall outlet.

2 Turn on the main power switch.

The main power indicator goes on.

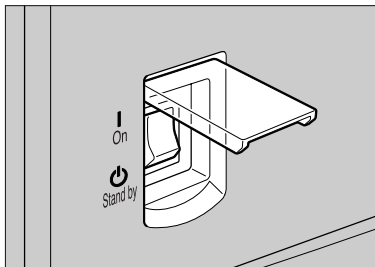

Important

- Do not turn off the main power switch immediately after turning it on. Doing so may result in damage to the memory, leading to malfunctions.

Turning On the Power

1 Press the operation switch.

The **On** indicator goes on.

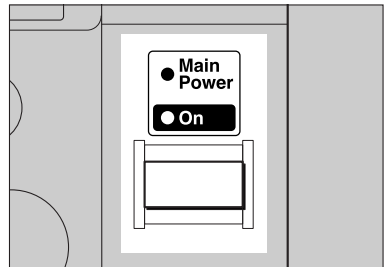

ZENH080N

Note

- If the power does not come on when the operation switch is pressed, check the main power switch is on. If it is off, turn it on.

Turning Off the Power

1 Press the operation switch.

The On indicator goes off.

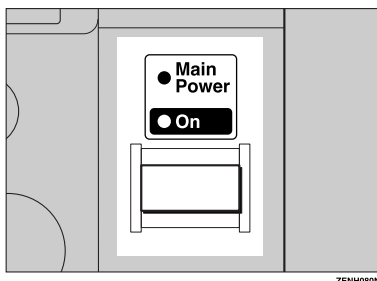

Note

- Even if you press the operation switch, the indicator does not go out, but blinks in the following cases:
 - During communication with external equipment.

Turning Off the Main Power

Important

- Do not turn off the main power switch when the **On** indicator is lit or blinking. Doing so may result in damage to the memory.
- Make sure 100% is shown as available memory on the initial scanner display before turning off the main power switch.
- Be sure to turn off the main power switch before pulling out the power plug. Not doing this may result in damage to the memory.

1 Be sure the On indicator is not lit.

2 Turn off the main power switch.

The main power indicator goes out.

When the fax unit (optional) is installed

When the main power switch is turned off while using the fax function, waiting fax and print jobs may be canceled, and incoming fax documents not received. If you have to turn off this switch for some reason, keep the following points in mind:

Important

- Make sure 100% is shown as available memory on the display before turning off the main power switch or unplugging the power cord. Fax files in memory are deleted an hour after you turn off the main power switch or unplug the power cord. See "Turning Off the Main Power/In Case of a Power Failure", *Facsimile Reference <Advanced Features>*.
- If the **On** indicator does not go out, but blinks in dial-in mode even if you press the operation switch, check the explanations below and turn off the main power switch.
 - the computer is not controlling the machine.
 - the machine is not receiving a fax.

Saving Energy

 **Auto Off/ Low Power**

The machine automatically turns itself off when the job is finished, after a certain period of time has elapsed. This function is called “Auto Off”.

 **Note**

- You can change the Auto Off time. See *General Settings Guide*.
- The Auto Off Timer function will not operate in the following cases:
 - When a warning message appears
 - When the service call message appears
 - When paper is jammed
 - When the cover is open
 - When the “Add Toner” message appears
 - When toner is being replenished
 - When the User Tools screen is displayed
 - When fixed warm-up is in progress
 - When the facsimile, printer, or other functions are active
 - When operations are suspended during printing
 - When the On-hook dialing function is in use
 - When a receiver is being registered in the Address Book or group dial list
 - When the Data In indicator is on or blinking









1. Placing Originals







Originals

Sizes and Weights of Recommended Originals

❖ Metric version

Original location	Original size	Original weight
Exposure glass	Up to A3	--
ADF or ARDF	One-sided originals: A3  – A5  	40–128 g/m ²
	Two-sided originals: * ¹ A3  – A5  	52–105 g/m ² * ¹

❖ Inch version

Original location	Original size	Original weight
Exposure glass	Up to 11" × 17"	--
ADF or ARDF	One-sided originals: 11" × 17"  – 5 ¹ / ₂ " × 8 ¹ / ₂ "  	11–34 lb.
	Two-sided originals * ¹ : 11" × 17"  – 5 ¹ / ₂ " × 8 ¹ / ₂ "  	14–28 lb. * ¹

*¹ The optional ARDF is required.

Note

- About 30 originals can be placed in the ADF.
- About 50 originals can be placed in the ARDF.

Non-compatible originals for the ADF or ARDF

Placing the following types of originals in the ADF or ARDF can cause paper misfeeds or result in damage to the originals. Place these originals on the exposure glass instead.

- Originals other than those specified on p.15 “Sizes and Weights of Recommended Originals”
- Stapled or clipped originals
- Perforated or torn originals
- Curled, folded, or creased originals
- Pasted originals







- Originals with any kind of coating, such as thermal fax paper, art paper, aluminum foil, carbon paper, or conductive paper
- Originals with perforated lines
- Originals with indexes, tags, or other projecting parts
- Sticky originals such as translucent paper
- Thin, highly flexible originals
- Thick originals such as postcards
- Bound originals such as books
- Transparent originals such as OHP transparencies or translucent paper

 **Note**

- The original might become dirty if it is written with a pencil or a similar tool.

Sizes Detectable with Auto Paper Select





❖ Metric version

Size	A3 	B4 JIS *1 	A4 	B5 JIS *1 	B5 JIS *1 	A5 	8 1/2" × 13" 
Original location							
Exposure glass	○	○	○	×	○	×	○
ADF or ARDF	○	○	○	○	○	○	○

○ : Detectable size × : Undetectable size

*1 JIS: Japanese Industrial Standard

❖ Inch version

Size	11" × 17" 	8 1/2" × 14" 	8 1/2" × 13" 	8 1/2" × 11" 	5 1/2" × 8 1/2" 
Original location					
Exposure glass	○	○	○	○	×
ADF or ARDF	○	○	×	○	○

○ : Detectable size × : Undetectable size

❖ Exposure glass

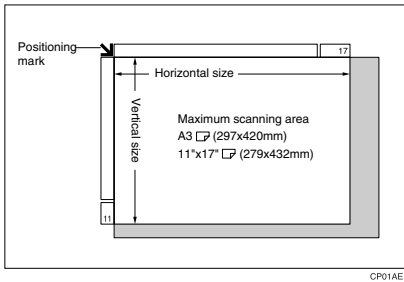

❖ ADF or ARDF

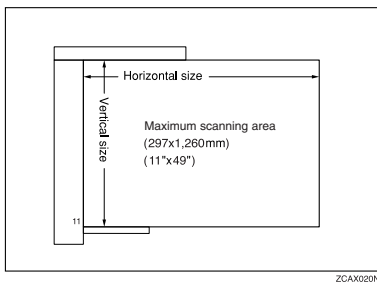

Note

- When you copy custom size originals, make sure you specify the size of the originals. If not, the image may not be copied properly. See p.20 "Placing custom size originals".

Sizes difficult to detect

It is difficult for the machine to detect the sizes of the following originals, so select the paper size manually.

- Originals with indexes, tags, or other projecting parts
- Transparent originals such as OHP transparencies or translucent paper
- Dark originals with lots of text and drawings
- Originals partially consisting of a solid image
- Originals that have solid images around their edges

Missing Image Area

Even if you place originals in the ADF or ARDF, or on the exposure glass correctly, 4 mm (0.2") margins on all four sides might not be copied.

Placing Originals

Note

- ❑ Take care to place originals only after any correction fluid and ink has completely dried. Not taking this precaution could cause marks on the exposure glass that will be copied onto paper.

Reference

For original sizes you can set, see p.15 “Originals”.

Original Orientation

You can set the original orientation in the following ways.

This function is useful for copying torn or large originals.

Note

- ❑ Originals should normally be aligned to the rear left corner. However, some copy functions may produce different results depending on the orientation of the originals. For details, see the explanations of each function.

Originals	ADF or ARDF	Exposure glass
	6611EE	
	6623EE	

Placing Originals on the Exposure Glass

- 1** Lift the exposure glass cover, ADF or ARDF.

Important

- ❑ Do not lift the exposure glass cover, ADF or ARDF forcefully. If you do, the ADF or ARDF cover might open or be damaged.

Note

- ❑ Be sure to lift the exposure glass cover, ADF or ARDF by more than 30°. Otherwise, the size of the original might not be detected correctly.

- 2** Place the original face down on the exposure glass. It should be aligned with the rear left corner.

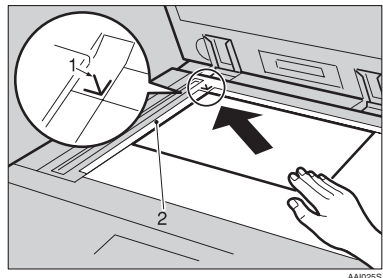

- 1.** Positioning mark

- 2.** Left scale

Note

- ❑ Start with the first page to be copied.

- 3** Lower the exposure glass cover, ADF or ARDF.

Placing Originals in the ADF or ARDF

Settings should be made in the following situations:

- ❖ **When placing custom size originals:**
p.20 “Placing custom size originals”

Note

- Do not stack originals over the limit mark on the side fence of the ADF or ARDF.
- The last page should be on the bottom.
- Do not cover the sensors with your hands, or place objects on them. Doing so could cause the size to be detected incorrectly, or the paper misfeed error message to appear. Also, do not place anything on the cover, as this too could cause a malfunction.

❖ ARDF

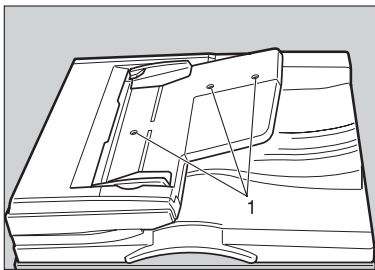

ZAAH280E

❖ ADF

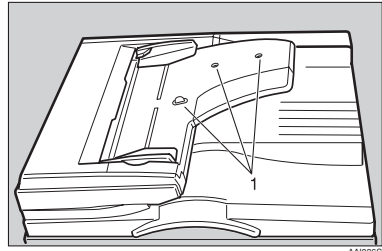

AAI036S

1. Sensor

- 1** Set the document guide to the original size.

- 2** Align the edges of the originals and place them in the ADF or ARDF with the side to be copied facing up.

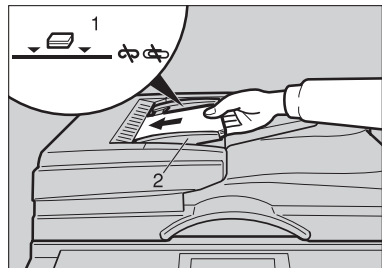

AAI026S

1. Limit mark

2. Document guide

Note

- Straighten curls in the originals before placing them in the ADF or ARDF.
- To prevent multiple sheets feeding in at once, fan the originals before placing them in the ADF, or ARDF.
- Set the original squarely.

Placing custom size originals

When placing custom size originals in the ADF, or ARDF, specify the size of the originals.

Note

- Paper that has a vertical length of 105–297 mm (4.2"–11.6") and a horizontal length of 128–1260 mm (5.1"–49.6") can be placed with this function.

- 1 Select the paper tray or bypass tray using **[▲]** or **[▼]**, and then press the **[#]** key.

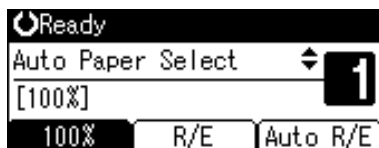

- 2 Enter the horizontal size of the original using the number keys, and then press the **[OK]** key.

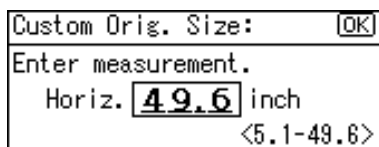

Note

- If you make a mistake, press the **[Clear/Stop]** key, and then enter the value again.

- 3 Enter the vertical size of the original using the number keys, and then press the **[OK]** key.

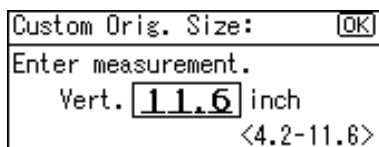

The "Accepted" message appears with your set original size.

When the custom size originals settings are registered, **[<]Ready** appears on the top of copy display.

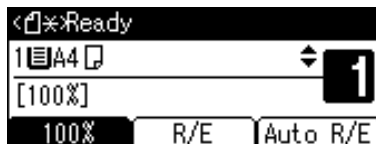

2. Copying

Basic Procedure

- 1 If the machine has user codes set, enter a user code (up to eight digits) using the number keys, and then press the **[OK]** or **[#]** key.

The machine is ready to copy.

Reference

For user codes, see “Key Operator Tools”, *General Settings Guide*.

- 2 Make sure "Ready" appears on the display.

◆ Initial copy display



If any other function is displayed, press the **[Copy]** key.

- 3 Make sure no previous settings remain.

Note

- When there are previous settings remaining, press the **[Clear Modes]** key and enter again.

- 4 Place your originals.

Reference

p.18 “Placing Originals”

- 5 Make the necessary settings.

Reference

See the explanations for each function.

- 6 Enter the number of copies using the number keys.

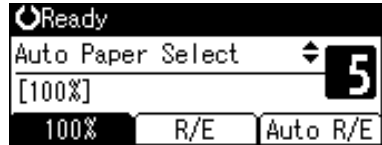

Note

- The maximum copy quantity that can be set is 99.

- 7 Press the **[Start]** key.

Copying starts.

Note

- Copies are delivered face down.

How to operate

- ◆ To switch between pages or select functions:

Press the scroll key.

- ◆ To stop the machine during a multi-copy run:

Press the **[Clear/Stop]** key.

- ◆ To return the machine to the initial condition after copying:

Press the **[Clear Modes]** key.

- ◆ To clear an entered value.

Press the **[Clear/Stop]** key.

Copying from the Bypass Tray

Use the bypass tray to copy onto OHP transparencies, thick paper, envelopes and copy paper that cannot be loaded in the paper trays.

2

Important









- Paper longer than 433 mm may become wrinkled, may not feed in, and may jam.

Note

- If you do not use standard size copy paper, or if you use special paper, you should enter its vertical and horizontal dimensions. See p.20 “Placing custom size originals”. The sizes you can enter are as follows:

Metric version	<ul style="list-style-type: none"> • Vertical: 90–297 mm • Horizontal: 148–600 mm
Inch version	<ul style="list-style-type: none"> • Vertical: 3.55”–11.69” • Horizontal: 5.83”–23.62”

- The machine can automatically detect the following sizes as regular size copy paper:

Metric version	A3  , A4  , A5  , 8" × 13" 
Inch version	11" × 17"  , 8 1/2" × 11"  , 5 1/2" × 8 1/2"  , 8 1/2" × 14" 

- When copying onto OHP transparencies or paper heavier than 105 g/m² (about 28 lb.), you need to specify the paper type. See p.24 “When copying onto special paper”.
- The maximum number of sheets you can load at the same time depends on paper type. The maximum number of sheets should not exceed the upper limit.

1 Open the bypass tray.

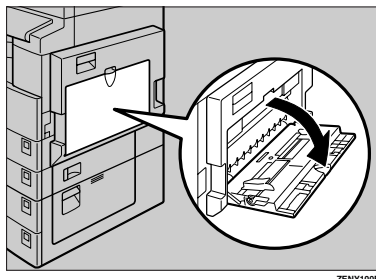

ZENY110E

2 Push up the paper guide release lever.

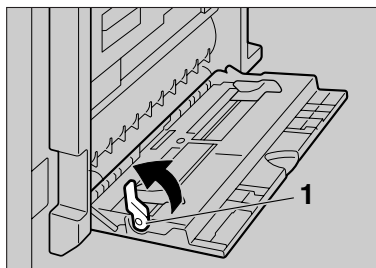

ZENY110E

1. Paper guide release lever

- 3** Insert the paper with the side you want to copy facing down, and then adjust the paper guide with the paper size.

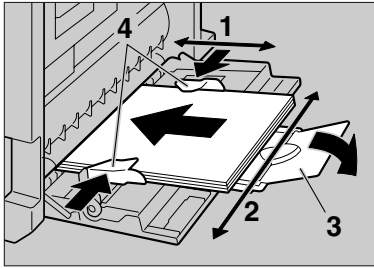

ZENY120E

1. Horizontal size
2. Vertical size
3. Extender
4. Paper guides

Note

- If the guides are not flush against the copy paper, images might be skewed or paper mis-feeds might occur.
- Do not stack paper over the limit mark, otherwise images might be skewed or paper mis-feeds might occur.
- Swing out the extender to support paper sizes larger than A4, 8¹/₂" × 11".
- Fan paper to get air between the sheets and avoid a multi-sheet feed.

- 4** Pull down the paper guide release lever (step 2).

The bypass tray is selected on the display.



Note

- If [Bypass] is not selected on the display, select [Bypass] using [▲] or [▼], and then press the [#] key.

- 5** Select the paper size and type.

When copying onto regular size paper

- 1** Select [Paper Size] using [▲] or [▼], and then press the [OK] key.



- 2** Select [Regular Size] using [▲] or [▼], and then press the [OK] key.

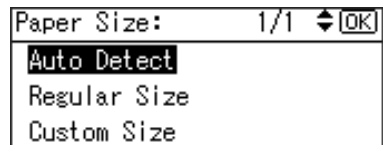

- 3** Select the paper size using the scroll keys, and then press the [OK] key.

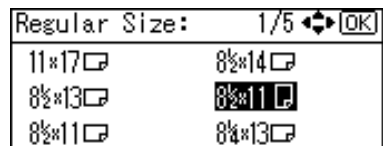

The "Accepted" message appears.

When copying onto custom size paper

Important

- You should specify the size of copy paper to avoid paper mis-feeds.

- 1 Select [Paper Size] using [▲] or [▼], and then press the [OK] key.

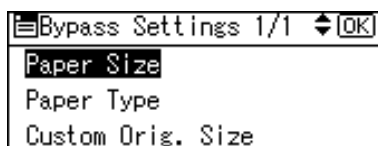

Bypass Settings 1/1 [OK]

Paper Size

Paper Type

Custom Orig. Size

- 2 Select [Custom Size] using [▲] or [▼], and then press the [OK] key.

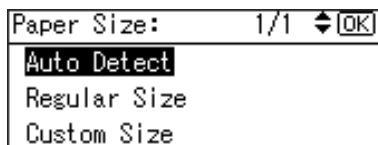

Paper Size: 1/1 [OK]

Auto Detect

Regular Size

Custom Size

- 3 Enter the horizontal size of the original using the number keys, and then press the [OK] key.

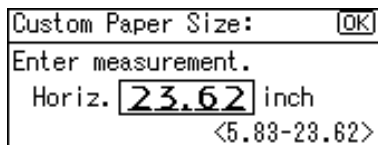

Custom Paper Size: [OK]

Enter measurement.

Horiz. 23.62 inch

<5.83-23.62>

Note

- If you make a mistake, press the [Clear/Stop] key, and then enter the value again.

- 4 Enter the vertical size of the original using the number keys, and then press the [OK] key.

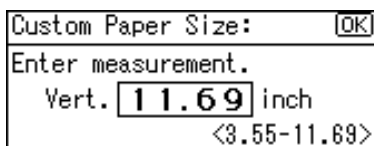

Custom Paper Size: [OK]

Enter measurement.

Vert. 11.69 inch

<3.55-11.69>

The “Accepted” message appears.

When copying onto special paper

- 1 Select [Paper Type] using [▲] or [▼], and then press the [OK] key.



Bypass Settings 1/1 [OK]

Paper Size

Paper Type

Custom Orig. Size

- 2 Select the paper type, and then press the [OK] key.

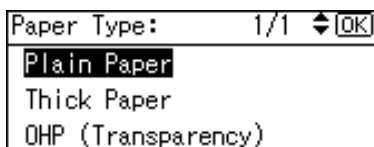

Paper Type: 1/1 [OK]

Plain Paper

Thick Paper

OHP (Transparency)

The “Accepted” message appears.

When copying onto envelopes

- 1 Select [Paper Size] using [▲] or [▼], and then press the [OK] key.



Bypass Settings 1/1 [OK]

Paper Size

Paper Type

Custom Orig. Size

- 2 Select [Regular Size] using [▲] or [▼], and then press the [OK] key.

Paper Size:	1/1	↕ [OK]
Auto Detect		
Regular Size		
Custom Size		

- 3 Select the envelope size from [C6 env] [C5 env] [DL env], and then press the [OK] key.

Regular Size:	1/5	↕ [OK]
11×17	8½×14	
8½×13	8½×11	
8½×11	8½×13	

The “Accepted” message appears.

- 4 Press the [#] key.

Ready	
C6 Env	1
[100%]	
100%	R/E Auto R/E

- 5 Select [Paper Type] using [▲] or [▼], and then press the [OK] key.

Bypass Settings 1/1	↕ [OK]
Paper Size	
Paper Type	
Custom Orig. Size	

- 6 Select [Thick Paper] using [▲] or [▼], and then press the [OK] key.

Paper Type:	1/1	↕ [OK]
Plain Paper		
Thick Paper		
OHP (Transparency)		

The “Accepted” message appears.

- 6 Place your originals, and then press the [Start] key.

 **Note**

- When copying onto OHP transparencies, remove copied sheets one by one.

- 7 When your copy job is finished, press the [Clear Mode] key to clear settings.

Copier Functions

2

Adjusting Image Density

You can adjust copy image density to match your originals.

If you require darker or lighter copies, adjust image density accordingly.

- 1 Press the **[Lighter]** or **[Darker]** key to adjust the density.

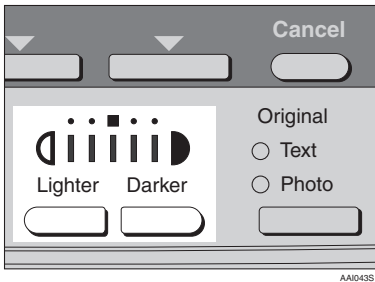

- 1 Press the **[Original]** key and select the original type.

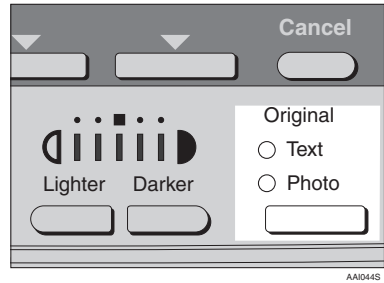

Note

- Press the **[Original]** key to go through the following types:

Upper indicator lit	Text
Lower indicator lit	Photo

Selecting Original Type Setting

Select one of the following two types to match your originals:

- ❖ **Text**
Select this when your originals contain only text (no pictures).
- ❖ **Photo**
This can reproduce delicate tones of photographs and pictures.

Reference
p.53 "Original Type Setting"

Selecting Copy Paper

There are two ways to select copy paper:

- ❖ **Auto Paper Select**
The machine selects a suitable size of copy paper automatically based on original size and reproduction ratio.
- ❖ **Manual Paper Select**
Choose the tray containing the paper you want to copy onto: a paper tray or the bypass tray.

Reference
p.17 "Sizes difficult to detect"

Note

- If you specify all paper trays as containing special paper, you cannot use the Auto Paper Select function.

Auto Paper Select

- 1 Make sure [Auto Paper Select] is selected.

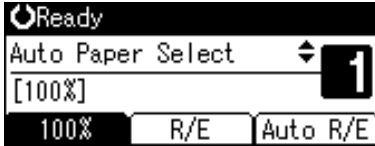

Manual Paper Select

- 1 Select the paper tray or bypass tray using [▲] or [▼].

The selected tray and the paper size appear.



Reference

p.22 "Copying from the Bypass Tray"

Rotated copy

If the orientation in which your original is placed (☐ or ☐) is different from that of the paper you are copying onto, this function rotates the original image by 90° to fit it on the copy paper. This function works when [Auto Paper Select] or [Auto Reduce/Enlarge] is selected. See p.26 "Auto Paper Select".

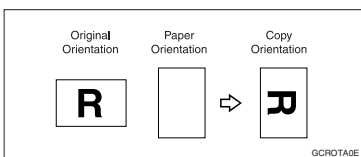

Note

- ☐ You cannot use the Rotated Copy function when enlarging onto 11" × 17", 8 1/2" × 13", 8 1/2" × 14" or A3, B4 JIS size paper. To do this, place your original in the ☐ orientation.

	Original size and orientation	Copy paper size and orientation
You cannot rotate:	8 1/2" × 11" or 5 1/2" × 8 1/2"	 When enlarging to: 8 1/2" × 14" or 11" × 17"
However, you can use:	8 1/2" × 11" or 5 1/2" × 8 1/2"	 When enlarging to: 8 1/2" × 14" or 11" × 17"

Preset Reduce/Enlarge

You can select a preset ratio for copying.

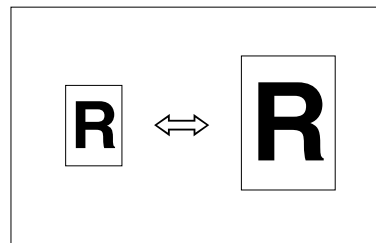

❖ **Base Point**

The base point of Reduce/Enlarge differs depending on how the original is scanned. When the original is placed on the exposure glass, the upper left corner is the base point. When placed in the ADF or ARDF, the bottom left corner is the base point.

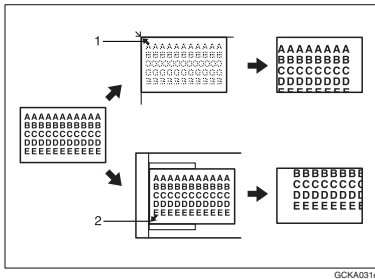

1. Base point when placing on the exposure glass.

2. Base point when placing in the ADF or ARDF.

Reference

- Related default settings
- p.54 "Reproduction Ratio"
- p.55 "Preset R/E Priority"

1 Press [R/E].

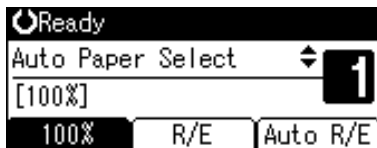

2 Press [Reduce] or [Enlarge].

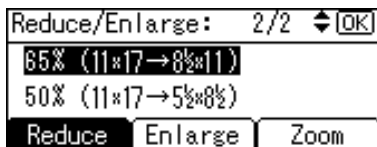

3 Select a ratio using [▲] or [▼], and then press the [OK] key.

The "Accepted" message appears.

4 Place your originals, and then press the [Start] key.

Zoom

You can change the reproduction ratio in increments of 1%.

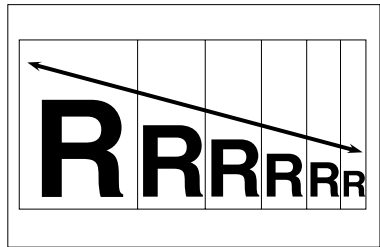

Note

- ☐ You can also select a preset ratio close to the desired ratio using [Reduce] or [Enlarge], and then adjust the ratio using [▲] or [▼].

1 Press [R/E].

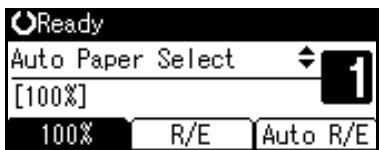

2 Press [Zoom].

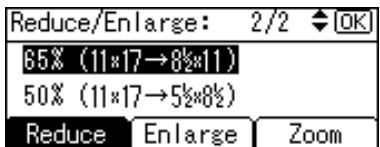

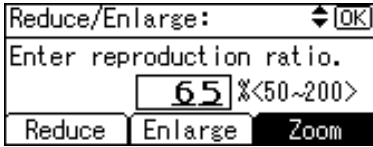
3 Enter the ratio.

To select the ratio using **[▲]** and **[▼]**

1 Adjust the ratio using **[▲]** or **[▼]**.**Note**

- If you have incorrectly entered the ratio, readjust using **[▲]** or **[▼]**.
- To change the ratio in increments of 10%, press and hold down **[▲]** or **[▼]**.

2 Press the **[OK]** key.

The "Accepted" message appears.

To enter the ratio using the number keys

1 Enter the desired ratio using the number keys.**2** Press the **[OK]** key.

The "Accepted" message appears.

4 Place your originals, and then press the **[Start]** key.**Auto Reduce/Enlarge**

You can choose an appropriate reproduction ratio based on the paper and original sizes you select.

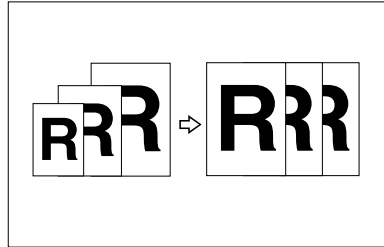
**Note**

- You cannot use the bypass tray with this function.
- When using Auto Reduce/Enlarge, see the following table for original sizes and orientations you can use:

◆ Metric version

Original location	Original size and orientation
Exposure glass	A3☐, B4 JIS☐, A4☐☐, B5 JIS☐☐, 8 ¹ / ₂ " × 13"☐
ADF or ARDF	A3☐, B4 JIS☐, A4☐☐, B5 JIS☐☐, A5☐☐, 8 ¹ / ₂ " × 13"☐

◆ Inch version

Original location	Original size and orientation
Exposure glass	11" × 17"☐, 8 ¹ / ₂ " × 14"☐, 8 ¹ / ₂ " × 11"☐☐, 8 ¹ / ₂ " × 13"☐
ADF or ARDF	11" × 17"☐, 8 ¹ / ₂ " × 14"☐, 8 ¹ / ₂ " × 11"☐☐, 5 ¹ / ₂ " × 8 ¹ / ₂ "☐☐

Reference

p.17 "Sizes difficult to detect"

- 1 Press **[Auto R/E]**.

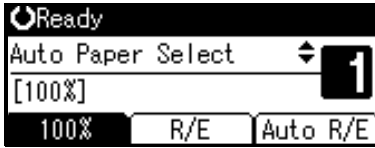

2

- 2 Select the paper tray using **[▲]** or **[▼]**.

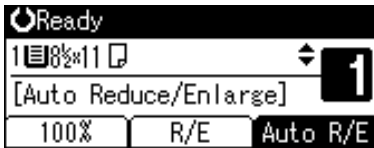

- 3 Place your originals, and then press the **[Start]** key.

Sort

You can scan originals into memory and automatically sort copies.

Reference

- Related default settings
- p.53 "Auto Tray Switching"
- p.55 "Rotate Sort"
- p.55 "Rotate Sort:Auto Continue"

Sort

Copies are assembled as sequentially ordered sets.

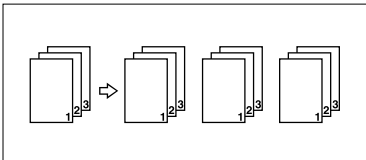

Rotate Sort

Every other copy set is rotated by 90° and delivered to the copy tray.

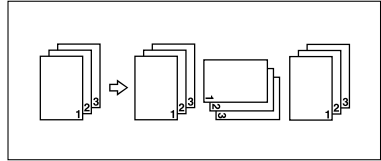

Note

- To use the Rotate Sort function, select **[On]** in **[Rotate Sort]** under **[Copier Features]** (User Tools). See p.55 "Rotate Sort".
- To use the Rotate Sort function, two paper trays loaded with the same size and type paper, but in different orientation (landscape/portrait), are required. See "Paper Type: Tray 1-4" in "Tray Paper Settings", *General Settings Guide*.

- 1 Press the **[Sort]** key.

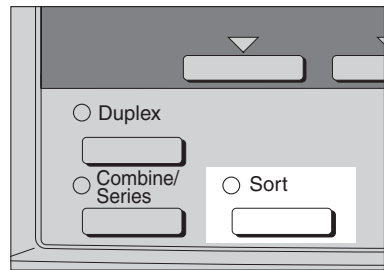

AA0455

Note

- When canceling the Sort function, press the **[Sort]** key, and make sure the **[Sort]** key indicator is off.

- 2** Select [Sort] or [Rotate Sort], and then press the **[OK]** key.

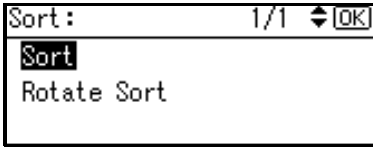

- 3** Enter the number of copy sets using the number keys.

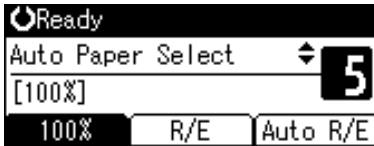

- 4** Place your originals.

Note

- When placing originals on the exposure glass, start from the first page to be copied. When placing originals in the ADF or ARDF, set the first page on top.

- 5** Press the **[Start]** key.

Note

- When placing originals on the exposure glass, press the **[#]** key after all originals are scanned.

Changing the number of sets

You can change the number of copy sets during copying.

Note

- This function can only be used when the Sort function is selected.

- 1** While “Copying...” is displayed, press the **[Clear/Stop]** key.

- 2** Press **[Sets]**.

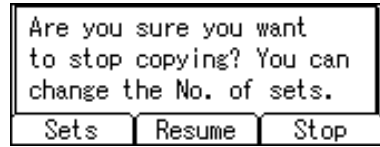

- 3** Enter the number of copy sets with the number keys, and then press **[Resume]**.

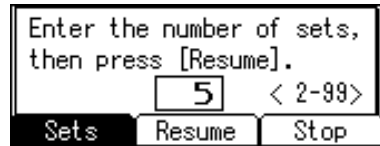

Copying starts again.

Note

- The number of sets you can enter differs depending on when the **[Clear/Stop]** key is pressed.

Duplex (Type 3 only)

There are two types of duplex:

◆ **1 Sided → 2 Sided**

Copies 2 one-sided pages onto 1 two-sided page.

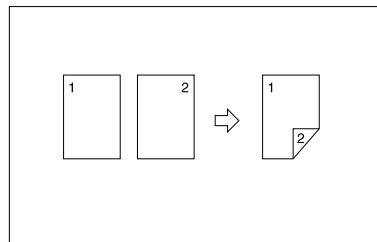

❖ **2 Sided → 2 Sided (Optional ARDF is required)**

Copies 1 two-sided page onto 1 two-sided page.

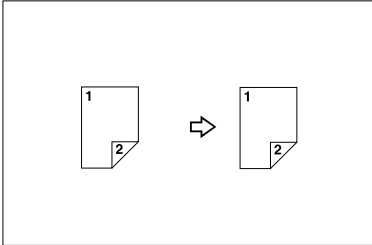

2

Original orientation and completed copies

The resulting copy image will differ according to the orientation in which you place the originals (vertical or horizontal).

Original	How to place your original	Copy
Vertical 	Standard 	Top to Top
	90° turn 	Top to Bottom
Horizontal 	Standard 	Top to Top
	90° turn 	Top to Bottom

GCRY01E

*1 The table shows the orientation of images on the front and back of copies, not the orientation of delivery.

Note

- You cannot use the bypass tray with this function.
- The maximum paper weight that can be used with duplex copying is 64–90 g/m², 20–24 lb.
- You can change the margin. See p.55 “Duplex Margin”.

1 Press the [Duplex] key.

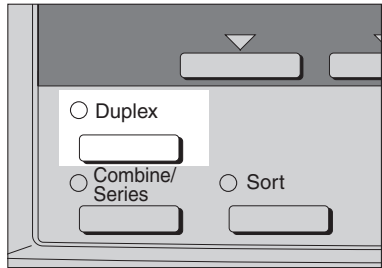

AA0465

2 Select the setting of original and copy type using [▲] or [▼], and then press the [OK] key.

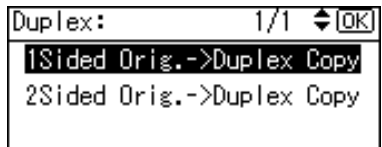

3 Select the orientation using [▲] or [▼], and then press the [OK] key.

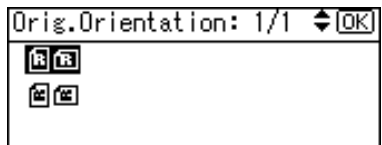

Note

- You can select the orientation of originals and copying paper when **[Always Specify]** is specified for **[Orientation]** under **[Copier Features]** (User Tools). See p.54 "Orientation". If it was not specified for, proceed to step 3.

- 4** When selecting two-sided copying, select the orientation **[Top to Top]** or **[Top to Bottom]** using **[▲]** or **[▼]**, and then press the **[OK]** key.

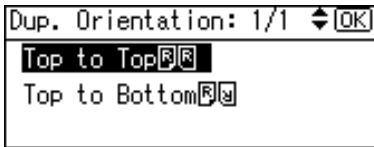
**Note**

- To change the copy orientation, select the original icon whose orientation is that required. See p.32 "Original orientation and completed copies".

The "Accepted" message appears.

- 5** Place your originals.

When placing originals on the exposure glass

- 1** Place the original, and then press the **[Start]** key.

Note

- Start from the first page to be copied.
- 2** Place the next original, and then press the **[Start]** key.

When placing a stack of originals in the ADF or ARDF

- 1** Place your originals, and then press the **[Start]** key.

Note

- Place the first page on top.

One-Sided Combine

You can combine several pages onto one side of a sheet.

◆ 1 Sided 2 Pages → Combine 1 Side

Copies 2 one-sided originals onto one side of a sheet.

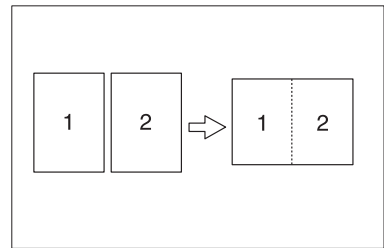

GCSHV77E

◆ 1 Sided 4 Pages → Combine 1 Side

Copies 4 one-sided originals onto one side of a sheet.

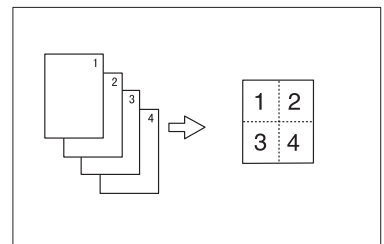

GCSHV8J

❖ **2 Sided 1 Page → Combine 1 Side (Optional ARDF is required)**

Copies 1 two-sided original onto one side of a sheet.

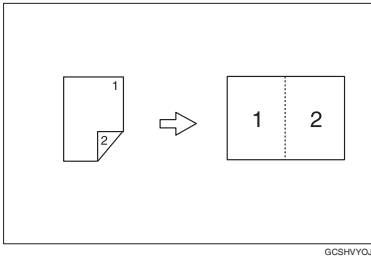

❖ **2 Sided 2 Pages → Combine 1 Side (Optional ARDF is required)**

Copies 2 two-sided originals onto one side of a sheet.

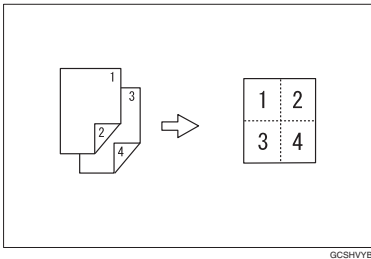

❖ **Orientation of the original and image position of combine**

Open to left originals

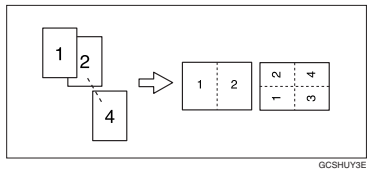

Open to top originals

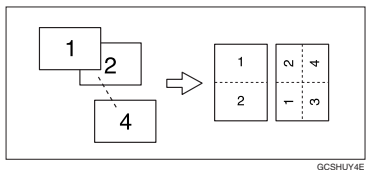

❖ **Placing originals (in the ADF or ARDF)**

- Originals read from left to right

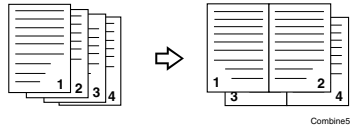

- Originals read from top to bottom

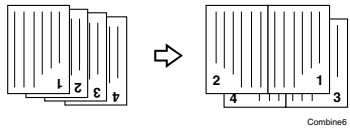

Note

- You cannot use the bypass tray with this function.

1 Press the **[Combine/Series]** key.

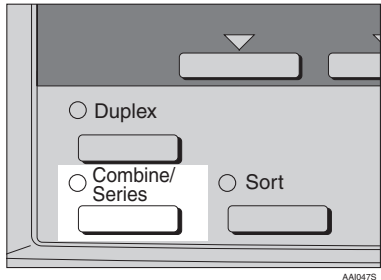

2 Select the combine mode using **[▲]** or **[▼]**, and then press the **[OK]** key.

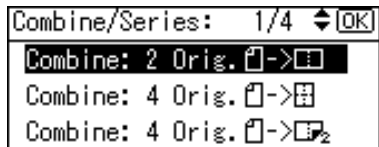

Reference

p.32 "Original orientation and completed copies"

- 3** Select the orientation using **[▲]** or **[▼]**, and then press the **[OK]** key.

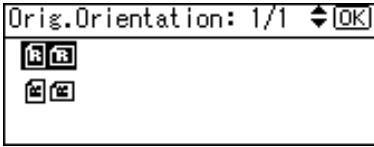

Note

- You can select the orientation of originals and copying paper when **[Always Specify]** is specified for **[Orientation]** under **[Copier Features]** (User Tools). See p.54 "Orientation". If it was not specified for, proceed to step **4**.
- To change the copy orientation, select the icon which orientation of originals is used.

The "Accepted" message appears.

- 4** Place your originals, and then press the **[Start]** key.

Two-Sided Combine (Type 3 only)

You can combine various pages of originals into one sheet with two sides.

- ◆ **1 Sided 4 Pages → Combine 2 Side**
Copies 4 one-sided originals onto one sheet with two pages per side.

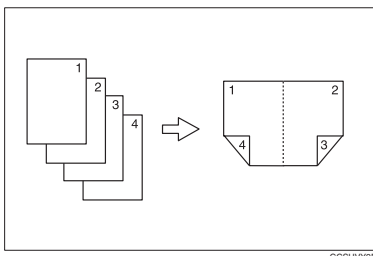

- ◆ **1 Sided 8 Pages → Combine 2 Side**
Copies 8 one-sided originals onto one sheet with four pages per side.

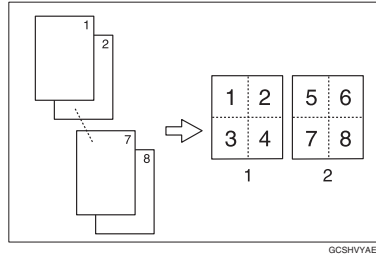

1. Front
2. Back

- ◆ **2 Sided 4 Pages → Combine 2 Side (Optional ARDF is required)**
Copies 2 two-sided originals onto one sheet with two pages per side.

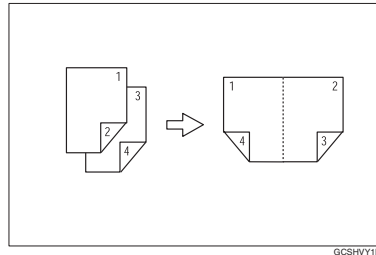

- ◆ **2 Sided 8 Pages → Combine 2 Side (Optional ARDF is required)**
Copies 4 two-sided originals onto one sheet with four pages per side.

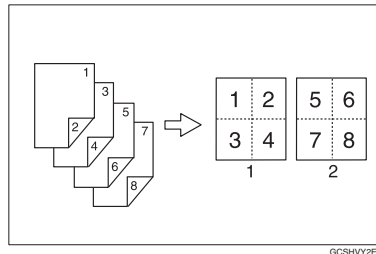

- 1 Press the **[Combine/Series]** key.

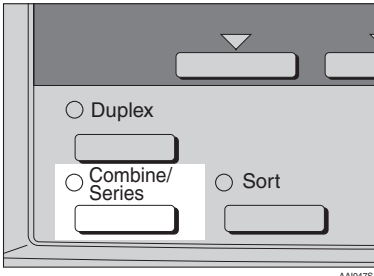

- 2 Select the combine mode using **[▲]** or **[▼]**, and then press the **[OK]** key.

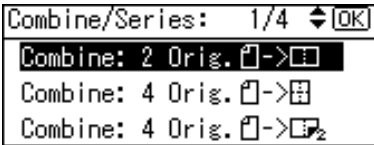

- 3 Select the orientation using **[▲]** or **[▼]**, and then press the **[OK]** key.

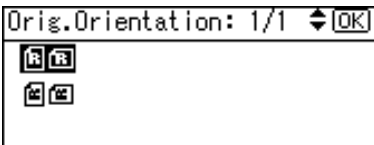

Note

- You can select the orientation of originals and two-sided copying paper when **[Always Specify]** is specified for **[Orientation]** under **[Copier Features]** (User Tools). See p.54 "Orientation". If it was not specified for, proceed to **5**.

- 4 When selecting two-sided copying, select the orientation **[Top to Top]** or **[Top to Bottom]** using **[▲]** or **[▼]**, and then press the **[OK]** key.

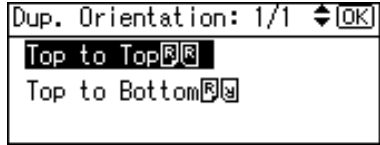

Note

- To change the copy orientation, select the original icon whose orientation is that required. See p.32 "Original orientation and completed copies".

The "Accepted" message appears.

- 5 Select the paper size using **[▲]** or **[▼]**.

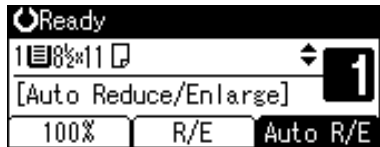

- 6 Place your originals, and then press the **[Start]** key.

Series Copies

You can separately copy the front and back of a two-sided original or two facing pages of a bound original onto two sheets.

❖ 2 Sided→1 Sided (Optional ARDF is required)

Copies each side of a two-sided original onto two separate pages.

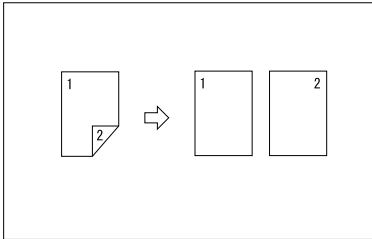

❖ Book→1 Sided

Copies two facing pages of a bound original (book) onto two separate pages.

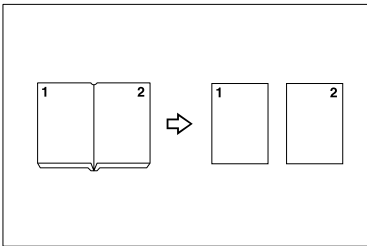

Note

- You cannot use the ADF or ARDF with Book→1 Sided function.
- You cannot use the bypass tray with Book→1 Sided function.
- See the following table for original and copy paper sizes when using a 100% ratio with Book→1 Sided function.

❖ Metric version

Original	Paper for one-sided copy
A3	A4 × 2 sheets
B4 JIS	B5 JIS × 2 sheets
A4	A5 × 2 sheets

❖ Inch version

Original	Paper for one-sided copy
11" × 17"	8 1/2" × 11" × 2 sheets
8 1/2" × 11"	5 1/2" × 8 1/2" × 2 sheets

1 Press the **[Combine/Series]** key

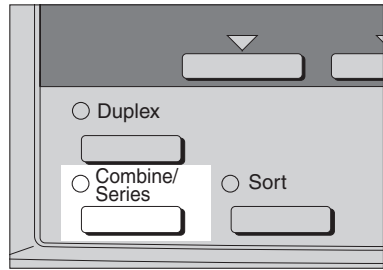

2 Select **[Series: Book Orig.]** or **[Series:2Sided Orig.]** using **[▲]** or **[▼]**, and then press the **[OK]** key.

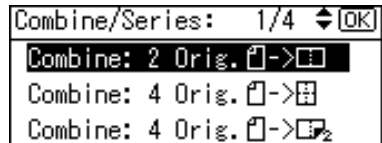

Note

- When selecting **[Series: Book Orig.]**, proceed to step 4.

- 3** When selecting [Series:2Sided Orig.], select the orientation using [▲] or [▼], and then press the [OK] key.

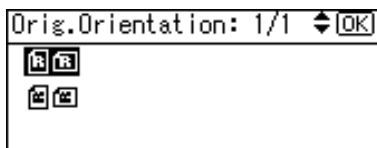

2

Note

- You can select the orientation of originals when [Always Specify] is specified for [Orientation] under [Copier Features] (User Tools). See p.54 "Orientation".

The "Accepted" message appears.

- 4** Select the paper tray using [▲] or [▼].

Note

- When you select [Series: Book Orig.], the following display appears.



- 5** Place your original, and then press the [Start] key.

3. Troubleshooting





If Your Machine Does Not Operate As You Want

When a Message Is Displayed

The following chart contains explanations for common messages. If other messages appear, follow the instructions as they are displayed.

 **Note**

For messages not listed here, see *General Settings Guide*.

Message	Causes	Solutions
Cannot detect original size	Improper original is placed. See p.17 "Sizes difficult to detect".	Select paper manually, not with the Auto Paper Select function, and do not use the Auto Reduce/Enlarge function.
		Input the both horizontal and vertical sizes of the non-standard original.
		Place the original on the exposure glass. See p.18 "Placing Originals on the Exposure Glass" .
	Original is not placed.	Place your originals.
Check original orientation	Original is not placed in the proper orientation.	Change original orientation.
Check paper size	Improper paper size is set.	If you press the [Start] key, copy will start onto the selected paper.
Rotate Sort is unavailable with this paper size	A size of paper for which Rotate Sort is not available is selected.	Select a proper paper size. See p.30 "Sort".
Cannot dup. copy this size	A paper size not available with the Duplex function has been selected.	The following paper sizes are available for the Duplex function: 11"×17"  , 8 1/2"×14"  and 8 1/2"×11"   . Select one of these sizes.
Max. number of sets is *	The number of copies exceeds maximum copy quantity.	You can change the maximum copy quantity. See p.54 "Max. Number of Sets" .

If You Cannot Make Clear Copies

3

Problem	Causes	Solutions
Copies appear dirty.	Image density is too dark.	Adjust the image density. See p.26 "Adjusting Image Density".
	Auto Image Density is not selected.	Adjust the auto image density. See p.26 "Adjusting Image Density".
The reverse side of an original image is copied.	Image density is too dark.	Adjust the image density. See p.26 "Adjusting Image Density".
	Auto Image Density is not selected.	Adjust the auto image density. See p.26 "Adjusting Image Density".
A shadow appears on copies if you use pasted originals.	Image density is too dark.	Adjust the image density. See p.26 "Adjusting Image Density". Change the orientation of the original. Put mending tape over the pasted areas.
The same copy area is dirty whenever making copies.	The exposure glass or ADF or, ARDF is dirty.	Clean them. See p.61 "Maintaining Your Machine".
Copies are too light.	Image density is too light.	Adjust the image density. See p.26 "Adjusting Image Density".
	The paper size is not appropriate.	Use the recommended paper. Note <input type="checkbox"/> A light copy may result when you use damp or rough grain paper.
	Toner bottle is almost empty.	Add toner. See p.47 "Adding Toner".
Parts of the paper are not copied.	The original is not placed correctly.	Place originals correctly. See p.18 "Placing Originals".
	An improper paper size is selected.	Select the proper paper size.
Copies are blank.	The original is not placed correctly.	When using the exposure glass, place originals face down. When using the ADF or ARDF, place them face up. See p.18 "Placing Originals".
A moiré pattern is produced on copies. 	Your original has a dot pattern image or many lines.	Place the original on the exposure glass at a slight angle.

If You Cannot Make Copies As You Want

This section explains causes and remedies when copy results are not as expected.

❖ Basic

Problem	Causes	Solutions
You cannot combine several functions.	Selected functions cannot be used together.	Check the combination of functions and make the settings again.  Reference p.63 "Combination Chart"

❖ Edit

Problem	Causes	Solutions
When using the Duplex Margin function, parts of the original image are not copied.	You set a wide erased margin.	Set a narrower margin with User Tools. You can set the width between 0–50 mm (0"–2"). See p.55 "Duplex Margin".
	There is a lack of margin space on the opposite side of the binding position.	

❖ Combine

Problem	Causes	Solutions
When using Combine, parts of the image are not copied.	You specified a reproduction ratio that does not match the sizes of your originals and copy paper.	When you specify a reproduction ratio using the Manual Paper Select function, make sure the ratio matches your originals and the copy paper.  Note <input type="checkbox"/> Select the correct reproduction ratio before using the Combine function.
	Your originals are not identical in size and direction.	Use originals that are identical in size and direction.
Copies are not in correct order.	You placed the originals in the incorrect order.	When placing a stack of originals in the ADF or ARDF, the last page should be on the bottom. If you place an original on the exposure glass, start with the first page to be copied.

❖ Duplex (Type 3 only)

Problem	Causes	Solutions
Order of copies is not correct.	You set originals in the incorrect order.	When setting a stack of originals in the ADF or ARDF, the last page should be on the bottom.
		If you set an original on the exposure glass, start with the first page to be copied.
In Duplex Margin mode, parts of the original image are not copied.	The margin is too wide.	Set a narrower margin with the user tools. See "Duplex Margin" in p.55 "Duplex Margin".
When using Duplex, copy is made Top to Top even though Top to Bottom is selected.	You placed the originals in the wrong orientation.	Place the originals in the correct orientation. See p.18 "Original Orientation" .

3

When Memory Is Full

Messages	Causes	Solutions
<p>Memory is full. [Print] scanned orig., [Clear] to cancel/clear memory. [Clear][Print]</p> <p> Note</p> <p><input type="checkbox"/> Copying will stop and this message will be displayed when the memory is full.</p>	The scanned original exceeds the number of pages that can be stored in memory.	Press [Print] to copy scanned originals and cancel the scanning data. Press [Clear] to cancel the scanning data and not copy.
<p>Reset * orig., then press [Resume] to scan and copy the remaining originals. [Stop] [Resume]</p>	The machine checks if the remaining originals should be copied, after the scanned original has been printed.	To continue copying, remove all copies, and then press [Resume] . To stop copying, press [Stop] .

Loading Paper

Reference

For paper types and sizes, see *General Settings Guide*.

Loading Paper

Note

- You can change the paper size, see *General Settings Guide*.
- This illustration shows the paper trays (1 or 2).

1 Pull the paper tray out slowly until it stops.

2 Square the paper and load it in the tray.

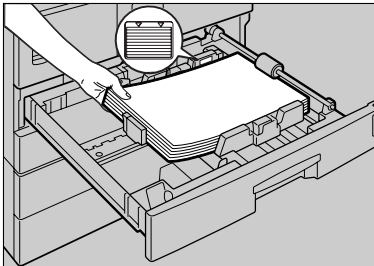

AA10225

Important

- Check the top of the stack is not higher than the limit mark inside the tray.

Note

- Fan the paper before loading.
- Straighten curled or warped paper before loading.
- When using paper tray 1 or 2, before loading paper, push down the metal plate.

3 Push the paper tray in, until it stops.

Orientation-Fixed Paper or Two-Sided Paper

Orientation-fixed (top to bottom) or two-sided paper (for example, letterhead paper, prepunched paper, or copied paper) might not print correctly, depending on how the originals and paper are placed.





Reference

p.55 “Letterhead Setting”

Note

- Select **[On]** in **[Letterhead Setting]** under **[Copier Features]** (User Tools), and then place the original and paper as shown below. When printing with the printer function, placing orientation is the same.
- Set the paper type to **[Letterhead]** in **[Tray Paper Settings]** under **[System Settings]**(User Tools). This setting is only available when the printer/scanner and fax units are installed. For details, see *General Settings Guide*.

Original Orientation

Exposure glass		ADF or ARDF	
	 *1 *2		 *2









*1 When copying in this orientation using the duplex function, and loaded paper orientation is , place originals as shown below:



*2 When copying in this orientation using the duplex function, select **[Always Specify]** in **[Orientation]** under **[Copier Features]**(User Tools). Place originals, and then select  as the original orientation.

❖ **Loaded paper orientation**

- For machine with copier function only

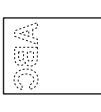
Copy mode		Paper tray	Bypass tray	
			When originals are placed on the exposure glass	When originals are placed in the ADF/ARDF
Loaded paper orientation 	1 Sided			
	2 Sided ₁		—	—
Loaded paper orientation 	1 Sided			
	2 Sided ₁		—	—

*1 Type 3 only









*2 Shows when printing on the front page.

 : Shows the paper frontside facing up.

 : Shows the paper backside facing up.

AAI0355

- For MFP

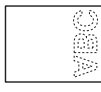
Copy mode		Paper tray	Bypass tray	
			When originals are placed on the exposure glass	When originals are placed in the ADF/ARDF
Loaded paper orientation 	1 Sided			
	2 Sided ^{*1}		—	—
Loaded paper orientation 	1 Sided			
	2 Sided ^{*1}		—	—

*1 Type 3 only

*2 Shows when printing on the front page.

 : Shows the paper frontside facing up.

 : Shows the paper backside facing up.

Adding Toner

When  appears, it is time to add toner.

Handling Toner

 **WARNING:**

- *Do not incinerate used toner or toner containers. Toner dust might ignite when exposed to an open flame. Dispose of used toner containers in accordance with local regulations.*

 **CAUTION:**

- *Keep toner (used or unused) and toner containers out of reach of children.*

 **Important**

- Faults may occur if you use toner other than the recommended type.
- When adding toner, do not turn off the operation switch. If you do, settings will be lost.
- Always add toner when the machine instructs you.
- Do not repeatedly install and remove toner bottles. This will result in toner leakage.
- Do not shake the removed toner bottle. Remaining toner might scatter.

 **Note**

- You can make about 50 copies even after the  symbol begins flashing, but replace toner early to prevent poor copy quality.

Toner Storage

When storing toner, the following precautions should always be followed:

- Store toner containers in a cool, dry place free from direct sunlight.
- Store on a flat surface.

Used Toner

 **Note**

- Toner cannot be re-used.

Removing Toner

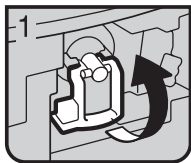

ZAAK040E

- 1: Open the front cover of the machine.
- 2: Lift the green lever.

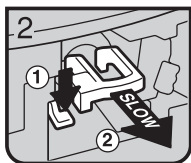

ZAAK050E

- 3: Push the green lever, and then gently pull out the holder.

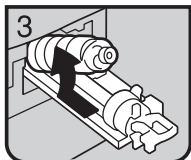

ZAAK060E

- 4: Press the toner bottle back to raise its top, and then gently pull it out.

3

Inserting Toner

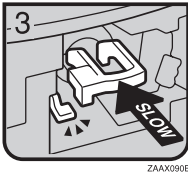
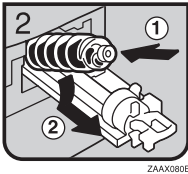
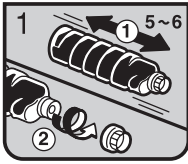

- 1: Hold the new bottle horizontally and shake it from side to side five or six times.
- 2: Remove the black cap.

Note

- Do not remove the black cap before shaking.
- Do not remove the inner cap.

- 3: Put the toner bottle on the holder, and then pull its top forward.

- 4: Push in the green lever until it clicks.

- 5: Press down the green lever.
- 6: Close the machine's front cover.

3

4. User Tools (Copier Features)

Accessing User Tools (Copier Features)

This section is for key operators in charge of this machine. Key operators can change or make default settings.

Note

- ❑ Be sure to quit User Tools and return to the initial copy display when all settings are complete. This section describes system settings for the copier function.
- ❑ Selected settings are highlighted.
- ❑ Any changes made with User Tools remain in effect even if the main power switch or operation switch is turned off, or the **[Clear Modes]** key is pressed.

Reference

For details, see "User Tools (System Settings)", *General Settings Guide*.

Changing Default Settings

Note

- ❑ If a key operator code is set, the key operator code input display appears before you can change the default settings. For details about access codes, see "Key Operator Tools", *General Settings Guide*.

- 1 Press the **[User Tools/Counter]** key.

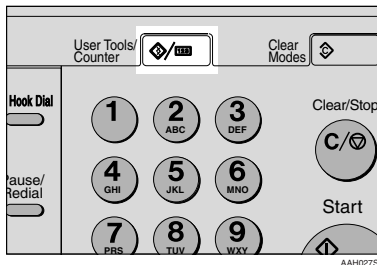

- 2 Select **[Copier Features]** using **[▲]** or **[▼]**, and then press the **[OK]** key.

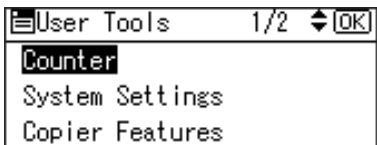

- 3 Select the menu using **[▲]** or **[▼]**, and then press the **[OK]** key.

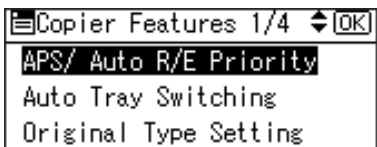

- 4 Change settings by following instructions on the display, and then press the **[OK]** key.

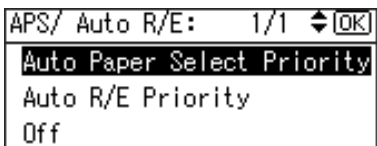

The "Programmed" message appears.

 **Note**

- ❑ To cancel changes made to setting and return to the initial display, press the **[User Tools/Counter]** key.

Quitting User Tools

- 1** Press the **[User Tools/Counter]** key.

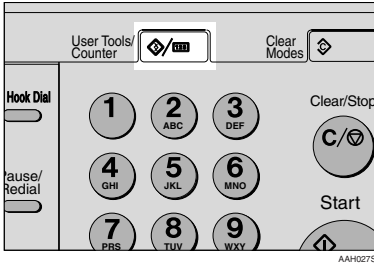

The change is made, and the machine is ready to copy.

Settings You Can Change with User Tools

APS/ Auto R/E Priority

You can select **[Auto Paper Select Priority]** (APS Priority) or **[Auto R/E Priority]** (Auto Reduce/Enlarge Priority). When you cancel this setting, select **[Off]**.

Note

- Default: *Auto Paper Select Priority*

Auto Tray Switching

If you load same size paper in two or more trays, the machine automatically shifts to the other tray using image rotation when the first tray runs out of paper (if **[On]** is selected.) This function is called "Auto Tray Switching". This setting specifies whether to use Auto Tray Switching or not.

Note

- Default: *On*
- Off: When a paper tray runs out of paper, copying is interrupted and the "Load paper" message appears.

Original Type Setting

You can adjust copy finish quality level according to original type. You can choose these functions after selecting **[Original Type 1 (Text)]** or **[Original Type 2 (Photo)]**.

- Text Mode 1
normal text originals
- Text Mode 2
newspapers, semi-transparent originals (reverse side print faintly visible)

- Photo Mode 1
text/photo images containing mostly photo areas
- Photo Mode 2
text/photo images containing mostly text areas
- Photo Mode 3
actual photographic paper
- Special Mode 1
Highly transparent originals (reverse side clearly visible), or light text on a colored background. Also for originals with very grainy backgrounds (some newspapers) and light text.
- Special Mode 2
originals with colored text and lines
- Special Mode 3
photo images created by dithering (visible dots), such as newspaper photos - normal resolution
- Special Mode 4
photo images created by dithering (visible dots), such as newspaper photos - coarse resolution
- Special Mode 5
normal text originals (reproducing the background)

Note

- Default:
 - *Original Type 1 (Text): Text Mode 1*
 - *Original Type 2 (Photo): Photo Mode 1*

Duplex Mode Priority

You can select the type of Duplex function effective when the machine is turned on, reset, or modes are cleared.

Limitation

- Available only for Type 3.

Note

- Default: *1 Sided* → *1 Sided*

Orientation

- Type 1, Type 2
You can select the original orientation when making Combine/Series copies.
- Type 3
You can select the original orientation when using the Combine/Series, or two-sided originals to one-sided Duplex function.

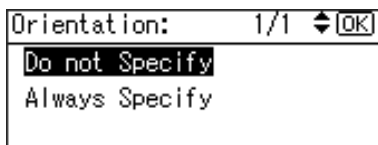

Note

- Default: *Do not Specify*
- When you select **[Always Specify]**, you must select the orientation of originals.

Max. Number of Sets

The maximum copy quantity can be set between 1 and 99 using number keys.

Note

- Default: *99 sheets*

Original Count Display

You can set to display the count of originals and copying pages on the display when **[On]** is selected.

Note

- Default: *Off*

Reproduction Ratio

You can select which reduce, enlarge, or input ratio is shown on the display with priority when **[Reduce]** or **[Enlarge]** is selected.

Note

- Default:
 - Metric version:
 - Ratio 1: 50%
 - Ratio 2: 71%
 - Ratio 3: 82%
 - Ratio 4: 93%
 - Ratio 5: 122%
 - Ratio 6: 141%
 - Ratio 7: 200%
 - Inch version:
 - Ratio 1: 50%
 - Ratio 2: 65%
 - Ratio 3: 78%
 - Ratio 4: 93%
 - Ratio 5: 121%
 - Ratio 6: 129%
 - Ratio 7: 155%

Preset R/E Priority

You can set the ratio with priority when **[R/E]** is selected.

Note

- Default:
 - Metric version: 71%
 - Inch version: 65%

Duplex Margin

You can specify left margin on the back side of copies, and top margin on the front side. Select **[Top Margin]** or **[Left Margin]**, and then set the required value.

- Top Margin: 0 - 50 mm, 0" - 2"
- Left Margin: 0 - 50 mm, 0" - 2"

Limitation

- Available only for Type 3

Note

- Default:
 - Metric version: 5 mm
 - Inch version: 0.2 inch

Rotate Sort

You can select a Sort function: **[On]** or **[Off]**.

When you select **[On]**, you can select **[Rotate Sort]**. See p.30 "Sort".

When you select **[Off]**, you cannot select **[Rotate Sort]**. If you press the **[Sort]** key, only Sort is enabled.

Note

- Default: *Off*
- When using Type 1 without the optional tray, you cannot use this setting.

Rotate Sort:Auto Continue

If you select **[Off]** when the paper tray in use runs out of paper, the machine stops, allowing you to add paper so all copies can be rotate-sorted.

Note

- Default: *Off*
- When using Type 1 without the optional tray, you cannot use this setting.

Letterhead Setting

If you select **[On]** for this function, the machine rotates the image correctly.

Note

- Default: *Off*
- Orientation-fixed (top to bottom) or two-sided paper (Type 3 only) might not print correctly, depending on how the originals and paper are placed.

Reference

When using letterhead paper, check its orientation is correct. See p.44 "Orientation-Fixed Paper or Two-Sided Paper".

4

Do's and Don'ts

CAUTION:

- *Unplug the power cord from the wall outlet before you move the machine. While moving the machine, you should take care that the power cord will not be damaged under the machine.*

Important

- Do not turn the power off while the On indicator is lit or blinking. Doing so may damage the memory.
- Before unplugging the power cord or turning off the main power switch, make sure remaining memory space is at 100%, as shown on the display. See p.13 “Turning Off the Power” and “Turning Off the Main Power”.
- When you use this machine for a long time in a confined space without good ventilation, you may detect an odd smell. To keep the workplace comfortable, we recommend that you keep it well ventilated.
- Do not touch areas on or around the fusing unit. These areas get hot.
- After making copies continuously, the exposure glass may become warm—this is not a malfunction.
- The area around the ventilation hole might feel warm. This is caused by exhaust air and is not a malfunction.
- When the machine is not in use and in stand-by mode, you may hear a small noise inside. This is caused by the image stabilization process and is not a malfunction.
- Do not turn off the operation switch while copying or printing. Make sure all copying or printing has finished first.
- The machine might not produce good copy images if condensation forms inside as a result of rapid temperature change.
- Do not open the covers of the machine while copying or printing. If you do, misfeeds might occur.
- Do not move the machine during copying or printing.
- If you operate the machine improperly or a machine failure occurs, settings might be lost. Be sure to make a note of your machine settings.
- The manufacturer shall not be liable for any loss or damage resulting from mechanical failure, loss of settings, or use of the machine.

Where to Put Your Machine

Machine Environment

Choose your machine's location carefully. Environmental conditions greatly affect its performance.

Optimum environmental conditions

⚠ CAUTION:

- *Keep the machine away from humidity and dust. Otherwise a fire or an electric shock might occur.*
- *Do not place the machine on an unstable or tilted surface. If it topples over, an injury might occur.*

⚠ CAUTION:

- *If you use the machine in a confined space, make sure there is a continuous air turnover.*
- Temperature: 10-32 °C (50-89.6 °F) (humidity to be 54% at 32 °C, 89.6 °F)
- Humidity: 15-80% (temperature to be 27 °C, 80.6 °F at 80%)
- A strong and level base.
- The machine must be level within 5 mm, 0.2 inches: both front to rear, and left to right.
- To avoid possible buildup of ozone, be sure to locate this machine in a large well ventilated room that has an air turnover of more than 30 m³/hr/person.

Environments to avoid

- Locations exposed to direct sunlight or other sources of strong light (more than 1,500 lux).
- Locations directly exposed to cool air from an air conditioner or heated air from a heater. (Sudden temperature changes can cause condensation to form inside the machine.)
- Locations close to machines generating ammonia, such as a diazo copy machine.
- Places where the machine will be subject to frequent strong vibration.
- Dusty areas.
- Areas with corrosive gases.

Moving

CAUTION:

- *Unplug the power cord from the wall outlet before you move the machine. While moving the machine, you should take care that the power cord will not be damaged under the machine.*

CAUTION:

- *Before moving the machine, be sure to pull all four handles fully out. If not, an injury might occur. After moving the machine, return the four handles to their original positions.*
- *When the optional paper tray unit is installed, do not push the upper part of the main unit horizontally. An injury might occur if the paper tray unit becomes detached from the main unit.*

Important

- Be careful when moving the machine. Take the following precautions:
 - Turn off the main power. See p.13 "Turning Off the Main Power".
 - Unplug the power cord from the wall outlet. When you pull out the plug from the socket, grip the plug to avoid damaging the cord, thereby reducing the risk of fire or electric shock.
 - Close all covers and trays, including the front cover and bypass tray.
- Do not take off the holding stand.
- Protect the machine from strong shocks. Impact can damage the memory.

Power Connection

WARNING:

- **Connect the machine only to the power source described on the inside front cover of this manual. Connect the power cord directly into a wall outlet and do not use an extension cord.**
- **Do not damage, break or make any modifications to the power cord. Do not place heavy objects on it. Do not pull it hard nor bend it more than necessary. These actions could cause an electric shock or fire.**

CAUTION:

- *Unplug the power cord from the wall outlet before you move the machine. While moving the machine, you should take care that the power cord will not be damaged under the machine.*

CAUTION:

- *When you disconnect the power plug from the wall outlet, always pull the plug (not the cable).*
- When the main power switch is in the stand-by position, the optional anti-condensation heaters are on. In an emergency, unplug the machine's power cord.
- When you unplug the power cord, the anti-condensation heaters turn off.
- Make sure the plug is inserted firmly in the wall outlet.
- Voltage must not fluctuate by more than 10%.
- The wall outlet shall be installed near the machine and shall be easily accessible.

Access to the Machine

Place the machine near the power source, providing the clearance areas shown.

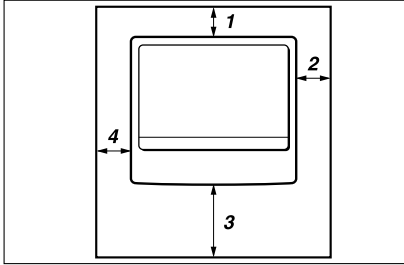

CP9991EE

5

1. Rear: 5 cm (2") or more
2. Right: 25 cm (10") or more
3. Front: 75 cm (29.6") or more
4. Left: 15 cm (6") or more

Note

- For the required space when options are installed, contact your service representative.

Maintaining Your Machine

If the exposure glass, exposure glass cover, ADF belt, or ARDF belt is dirty, copy clarity may be reduced. Clean these parts if they are dirty.

❖ Cleaning the machine

Wipe the machine with a soft, damp cloth. Then wipe it with a dry cloth to remove the water.

⚠ Important

- ❑ Do not use chemical cleaner or organic solvents such as thinner or benzene. If such substances get inside the machine or melt plastic parts, a failure might occur.
- ❑ Do not clean parts other than those explicitly specified in this manual. Other parts should only be cleaned by your service representative.

Cleaning the Exposure Glass

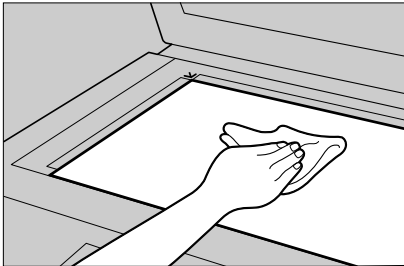

Cleaning the Exposure Glass Cover

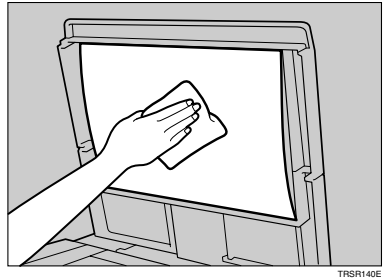

Cleaning the ADF or ARDF

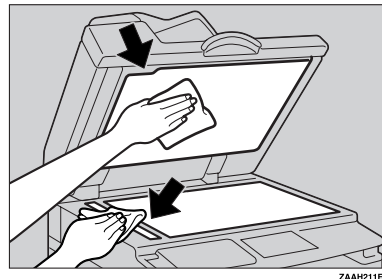

6. Specifications

Combination Chart

The combination chart below shows which functions can be used together. When you read the chart, see the following table:

○	These functions can be used together.
×	These functions cannot be used together. The first function selected will be the function you are working in.
●	These functions cannot be used together. The second function selected will be the function you are working in.

The following shows the combinations of functions.

		Function selected after													
		Auto Paper Select	Custom Size Originals	Bypass Tray	Manual Image Density	Text Originals	Photo Originals	Auto Reduce/Enlarge	Zoom	Combine	Book → 1 Sided	2 Sided → 1 Sided	1 Sided → 2 Sided	2 Sided → 2 Sided	Sort
Function selected first	Auto Paper Select		×	●	○	○	○	○	○	○	○	○	○	○	○
	Custom Size Originals	×		○	○	○	○	○	○	○	○	*1	*1	○	
	Bypass Tray	●	○		○	○	○	*3	○	*3	*3	○	*3	*3	*2
	Manual Image Density	○	○	○		○	○	○	○	○	○	○	○	○	○
	Text Originals	○	○	○	○		●	○	○	○	○	○	○	○	○
	Photo Originals	○	○	○	○	●		○	○	○	○	○	○	○	○
	Auto Reduce/Enlarge	×	○	*3	○	○	○		●	*4	●	○	○	○	○
	Zoom	○	○	○	○	○	○	○		●	○	○	○	○	○
	Combine	×	○	*3	○	○	○	○	○		●	●	●	●	○
	Book → 1 Sided	×	○	*3	○	○	○	×	○	●		●	●	●	○
	2 Sided → 1 Sided	○	*1	○	○	○	○	○	○	●	●		●	●	○
	1 Sided → 2 Sided	○	○	*3	○	○	○	○	○	●	●	●		●	○
	2 Sided → 2 Sided	○	*1	*3	○	○	○	○	○	●	●	●	●		○
	Sort	○	○	*2	○	○	○	○	○	○	○	○	○	○	

*1 You cannot combine two-sided original functions with originals longer than 432mm (□).

*2 This function cannot be combined copy paper longer than 432 mm (□).

*3 When you select these functions together, the error message appears.

You cannot copy until you cancel one function.

*4 Auto Reduce/Enlarge can be set to [ON] by selecting the Combine function.

AAI0215

Supplementary Information

❖ Bypass Tray Copy

- The following paper sizes can be selected as standard sizes:
A3, A4, A5, B4 JIS, B5 JIS, B6 JIS, 11"×17",
8¹/₂"×14", 8¹/₂"×11", 5¹/₂"×8¹/₂", 7¹/₄"×10¹/₂", 8"×13",
8¹/₂"×13", 8¹/₄"×13", 8K, 16K, 4¹/₈"×9¹/₂", 3⁷/₈"×7¹/₂", C5
Env, C6 Env, DL Env
- When the beeper is turned off, it will not sound if you insert paper into the bypass tray. See *General Settings Guide*.

❖ Preset Enlarge/Reduce

- You can select one of 7 preset ratios (3 enlargement ratios, 4 reduction ratios).
- You can select a ratio regardless of the size of an original or copy paper. With some ratios, parts of the image might not be copied or margins will appear on copies.
- Copies can be reduced or enlarged as follows:

❖ Metric version

Ratio (%)	Original → Copy paper size
200 (enlarge area by 4)	A5→A3
141 (enlarge area by 2)	A4→A3, A5→A4
122	F→A3, A4→B4 JIS
115	B4 JIS→A3
93	--
82	F→A4, B4 JIS→A4
71 (reduce area by 1/2)	A3→A4, A4→A5
65	A3→F
50 (reduce area by 1/4)	A3→A5, F→A5





❖ Inch version

Ratio (%)	Original → Copy paper size
200 (enlarge area by 4)	$5\frac{1}{2}'' \times 8\frac{1}{2}'' \rightarrow 11'' \times 17''$
155 (enlarge area by 2)	$5\frac{1}{2}'' \times 8\frac{1}{2}'' \rightarrow 8\frac{1}{2}'' \times 14''$
129	$8\frac{1}{2}'' \times 11'' \rightarrow 11'' \times 17''$
121	$8\frac{1}{2}'' \times 14'' \rightarrow 11'' \times 17''$
93	--
85	F → $8\frac{1}{2}'' \times 11''$
78	$8\frac{1}{2}'' \times 14'' \rightarrow 8\frac{1}{2}'' \times 11''$
73	$11'' \times 15'' \rightarrow 8\frac{1}{2}'' \times 11''$
65	$11'' \times 17'' \rightarrow 8\frac{1}{2}'' \times 11''$
50 (reduce area by $\frac{1}{4}$)	$11'' \times 17'' \rightarrow 5\frac{1}{2}'' \times 8\frac{1}{2}''$









❖ Zoom

- The reproduction ratios you can specify are 50–200%.
- You can select a ratio regardless of the size of an original or copy paper. With some ratios, parts of the image might not be copied or margins will appear on copies.

❖ Sort, Rotate Sort

- Paper sizes and orientations that can be used with the Rotate Sort function are A4 , B5 JIS , A5 , $8\frac{1}{2}'' \times 11''$ , and $5\frac{1}{2}'' \times 8\frac{1}{2}''$ .

❖ Duplex (Type 3 only)

- You cannot use the following copy paper with this function:
 - Paper smaller than $5\frac{1}{2}'' \times 8\frac{1}{2}''$ .
 - Paper thicker than 105 g/m², 28 lb.
 - Paper thinner than 64 g/m², 17 lb.
 - Translucent paper
 - OHP transparencies
 - Label paper (adhesive labels)
 - Postcards
- When an odd number of originals is placed in the ADF, the back of the last page of copied paper is blank.
- During copying, the image is shifted to allow for the binding margin.
- The following paper sizes can be duplexed: A3 , B4 JIS , A4 , B5 JIS , A5 , $11'' \times 17''$ , $8\frac{1}{2}'' \times 14''$ , $8\frac{1}{2}'' \times 11''$

❖ Combine

- When using this function, the machine selects the reproduction ratio automatically. This reproduction ratio depends on copy paper sizes and the number of originals.
- The reproduction ratios you can specify are 50–200%.
- If the calculated ratio is under the minimum ratio, it is automatically adjusted to within available range. However, with some ratios, parts of the image might not be copied.
- You cannot use custom size paper.
- If the orientation of originals is different from that of the copy paper, the machine will automatically rotate the image by 90° to make copies properly.
- If the number of originals placed is less than the number specified for combining, the last page segment is left blank as shown.

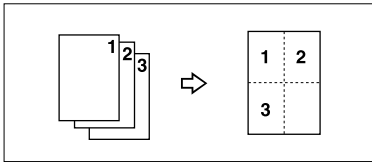

6

❖ Duplex Margin (Type 3 only)

- If you set a binding margin that is too wide, part of the image may not be copied.
- When making copies using the Combine function, the binding margin is added to the copies when combining is finished.

INDEX

-
- 1 Sided → 2 Sided, 31
 - 2 Sided → 1 Sided, 37
 - 2 Sided → 2 Sided, 32

A

- Accessing user tools
 - copier features*, 51
- Adding toner, 47
- Adjusting
 - image density*, 26
- Auto
 - paper select*, 26
 - reduce/enlarge*, 29
 - tray switching*, 53
- Auto Off/ Low Power, 14
- Auto paper select, 27

B

- Basic procedure, 21

C

- Cancel key, 9
- Changing default settings, 51
- Cleaning
 - ADF or ARDF*, 61
 - exposure glass*, 61
 - exposure glass cover*, 61
- Clear key, 8
- Clear Modes key, 8
- Combination chart, 63
- Combine
 - 1 sided 2 pages → 1 side*, 33
 - 1 sided 4 pages → 1 side*, 33
 - 1 sided 4 pages → 2 side*, 35
 - 1 sided 8 pages → 2 side*, 35
 - 2 sided 1 page → 1 side*, 34
 - 2 sided 2 pages → 1 side*, 34
 - 2 sided 4 pages → 2 side*, 35
 - 2 sided 8 pages → 2 side*, 35
- Combine key, 9
- Control panel, 8

Copier Features

- APS/auto r/e priority*, 53
- auto tray switching*, 53
- duplex margin*, 55
- duplex mode priority*, 54
- letterhead setting*, 55
- max. number of sets*, 54
- orientation*, 54
- original count display*, 54
- original type setting*, 53
- preset r/e priority*, 55
- reproduction ratio*, 54
- rotate sort*, 55
- rotate sort:auto continue*, 55

Copier features, 51

Copy functions, 26

- adjusting image density*, 26
- auto reduce/enlarge*, 29
- duplex*, 31
- one-sided combine*, 33
- preset reduce/enlarge*, 27
- selecting copy paper*, 26
- selecting original type setting*, 26
- series copies*, 37
- sort*, 30
- two-sided combine*, 35
- zoom*, 28

Copying, 21

- Copying from bypass tray, 22
 - onto custom size paper*, 24
 - onto envelopes*, 24
 - onto regular size paper*, 23
 - onto special paper*, 24

Copy key, 8

Counter key, 8

D

Display, 10

Do's and Don'ts, 57

Duplex

- 1 sided → 2 sided*, 31
- 2 sided → 2 sided*, 32

Duplex key, 9

E

Environment, 58

H

Handling toner, 47

I

Indicators, 8

Inserting toner, 49

L

Lighter and Darker, 9

Loading paper, 43

M

Machine environment, 58

Main power indicator, 9

Main power switch, 12

Maintaining, 61

Manual paper select, 27

Messages, 39

Missing image area, 17

Moving, 59

N

Non-compatible originals for the ADF or ARDF, 15

Number keys, 9

O

OK key, 9

One-sided combine

1 sided 2 pages → *combine 1 side*, 33

1 sided 4 pages → *combine 1 side*, 33

2 sided 1 page → *combine 1 side*, 34

2 sided 2 pages → *combine 1 side*, 34

On indicator, 9

Operation switch, 9, 12

Orientation-Fixed Paper or Two-Sided Paper, 44

Original

combine, 34

orientation, 18

orientation and completed copies, 32

Original key, 9

Originals, 15

P

Paper

loading, 43

Photo, 26

Placing

custom size originals, 20

originals, 18, 19, 20

originals in ADF/ARDF, 19

originals on exposure glass, 18

Placing Originals, 15

Power connection, 59

Q

Quitting user tools, 52

R

Reading

display, 10

using keys, 10

Remarks, 57

Removing toner, 48

Rotated copy, 27

S

Safety information, 4

Saving energy, 14

Scroll keys, 8

Selecting

copy paper, 26

original type setting, 26

Selection keys, 8

Series copies

2 sided → *1 sided*, 37

book → *1 sided*, 37

Series key, 9

Sizes

detectable by auto paper select, 16

difficult to detect, 17

of recommended originals, 15

Sort, 30

rotate sort, 30

Sort key, 9

Specifications, 63

Start key, 9

Stop key, 8

Supplementary information, 64
Supplementary informations, 65
 bypass tray copy, 64
 combine, 66
 duplex, 65
 duplex margin, 66
 preset enlarge/reduce, 64
 rotate sort, 65
 sort, 65
 zoom, 65

T

Text, 26
Toner
 adding, 47
 handling, 47
 inserting, 49
 removing, 48
 storage, 47
 used, 47
Toner storage, 47
Troubleshooting, 39
 memory is full, 42
 you cannot make clear copies, 40
 you cannot make copies as you want, 41
 your machine does not operate as you want, 39
Turning Off
 main power, 13
 power, 13
Turning On, 12
 main power, 12
 power, 12
Two-sided combine
 1 sided 4 pages → combine 2 side, 35
 1 sided 8 pages → combine 2 side, 35
 2 sided 4 pages → combine 2 side, 35
 2 sided 8 pages → combine 2 side, 35

U

Used toner, 47
User Tools, 51
User Tools key, 8

W

Weights
 of recommended originals, 15

MEMO

In accordance with IEC 60417, this machine uses the following symbols for the main power switch:

I means **POWER ON**.

⏻ means **STAND BY**.

Trademark

PostScript® and Acrobat® are registered trademarks of Adobe Systems Incorporated.

Other product names used herein are for identification purposes only and might be trademarks of their respective companies. We disclaim any and all rights in those marks.

Type for 8016/DSm616/LD116/Aficio 2016
Type for 8020/DSm620/LD120/Aficio 2020
Type for 8020d/DSm620d/LD120d/Aficio 2020D
Printed in China
EN (USA) B259-6607

